

ICT ENABLED TOOLS FOR EFFECTIVE TEACHING-LEARNING PROCESS

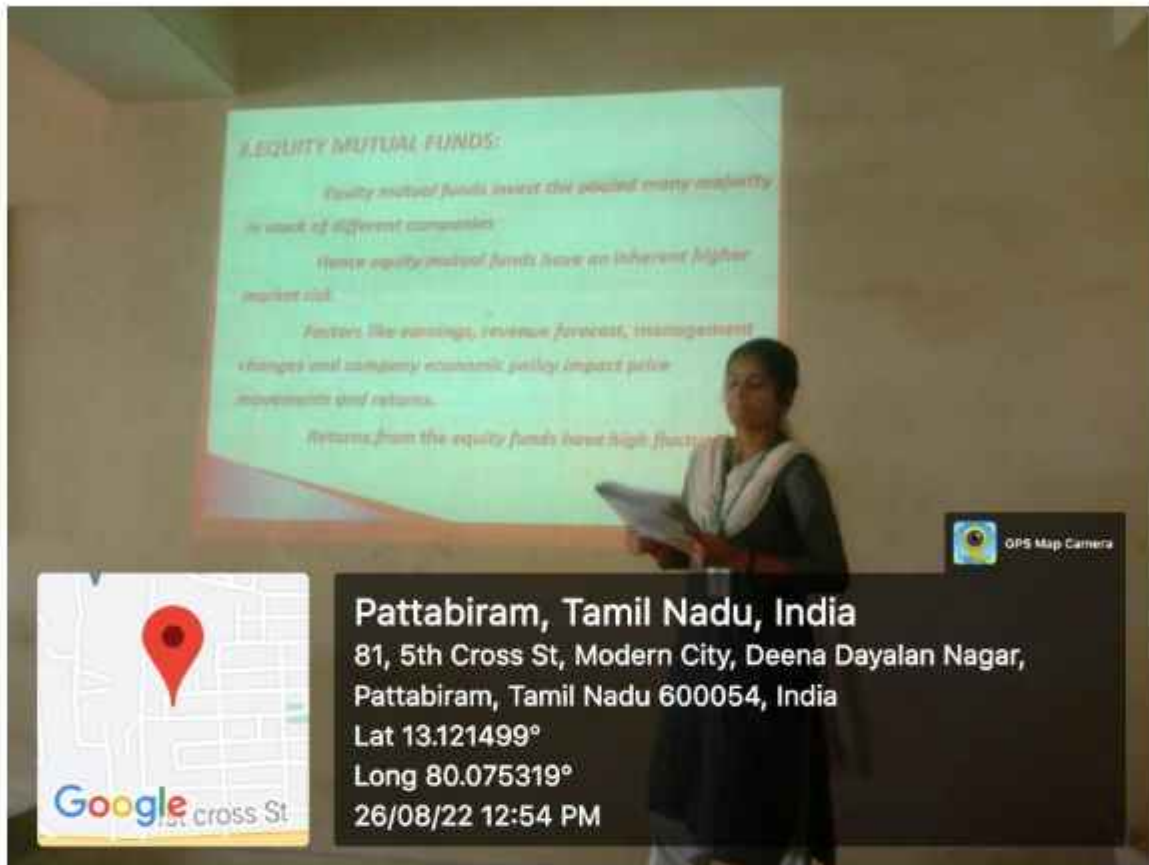

G. Kalvikarasi
Dr.G. KALVIKKARASI
PRINCIPAL
DHARMAMURTHI RAO BAHADUR
CALAVALA CUNNAN CHETTY'S HINDU COLLEGE
PATTABIRAM, CHENNAI-600072.



GPS Map Camera



Pattabiram, Tamil Nadu, India

CUNNAN RUBY JUBILEE BLOCK, FOOD CORPORATION OF INDIA-PATTABIRAM, Deena Dayalan Nagar, Pattabiram, Tamil Nadu 600054, India

Lat 13.121726°

Long 80.073087°

23/09/22 12:12 PM GMT +05:30



G. Kalvikkarasi

Dr.G. KALVIKKARASI
PRINCIPAL
DHARMAMURTHI RAO BAHADUR
CALAVALA CUNNAN CHETTY'S HINDU COLLEGE
PATTABIRAM, CHENNAI-600072.

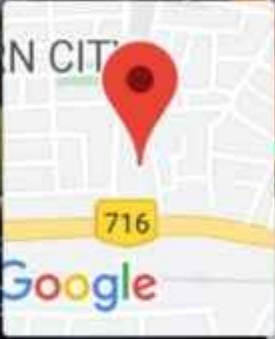
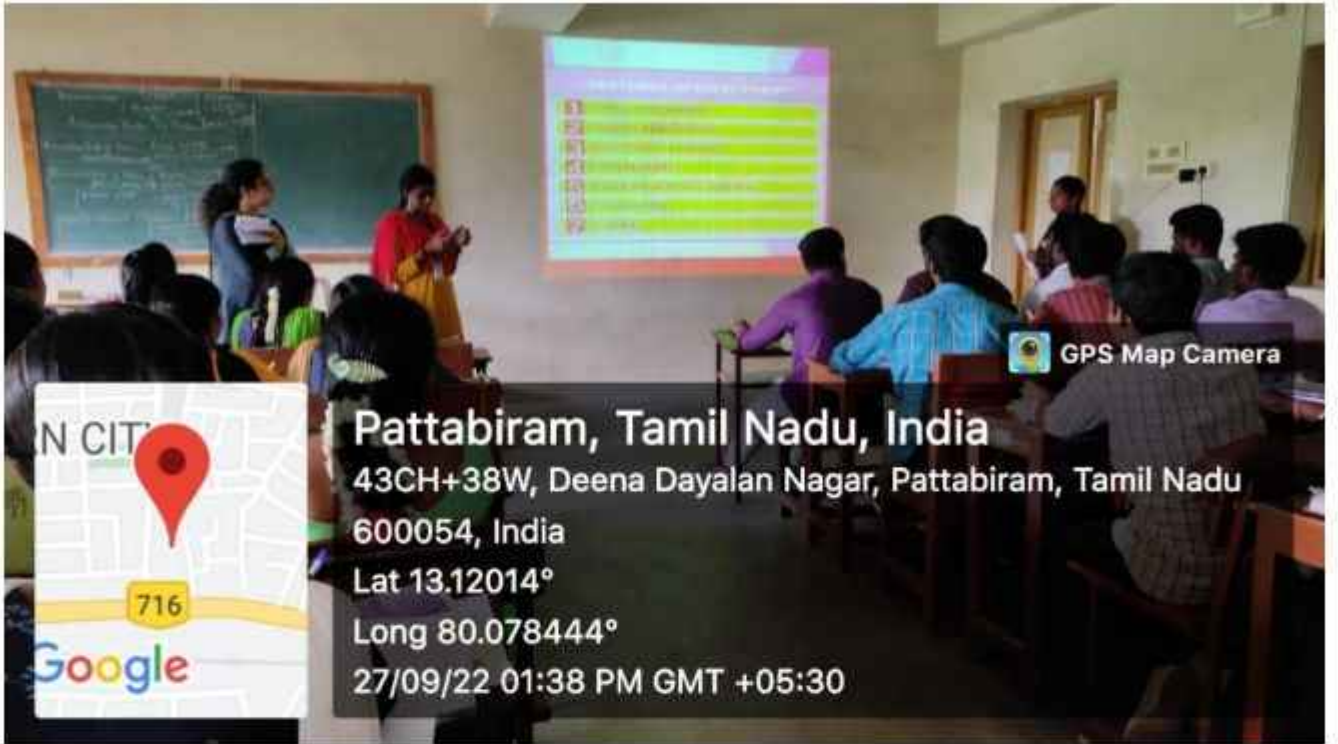

Pattabiram, Tamil Nadu, India

43CH+38W, Deena Dayalan Nagar, Pattabiram, Tamil Nadu
600054, India

Lat 13.12014°

Long 80.078444°

27/09/22 01:38 PM GMT +05:30

GPS Map Camera



Pattabiram, Tamil Nadu, India

7, Anna Nagar Main Rd, Modern City, Deena Dayalan Nagar,
Pattabiram, Tamil Nadu 600072, India

Lat 13.119113°

Long 80.078112°

24/09/22 01:26 PM GMT +05:30

GPS Map Camera



G. Kalvikkarasi

Dr. G. KALVIKKARASI

PRINCIPAL

DHARMAMURTHI RAO BAHADUR
CALAVALA CUNNAN CHETTY'S HINDU COLLEGE
PATTABIRAM, CHENNAI-600072.



G. Kalvikkarasi

Dr.G. KALVIKKARASI

PRINCIPAL

DHARMAMURTHI RAO BAHADUR

CALAVALA CUNNAN CHETTY'S HINDU COLLEGE

PATTABIRAM, CHENNAI-600072.



GPS Map Camera



Pattabiram, Tamil Nadu, India

SCIENCE BLOCK, FOOD CORPORATION OF INDIA-PATTABIRAM,

Deena Dayalan Nagar, Pattabiram, Tamil Nadu 600054, India

Lat 13.121785°

Long 80.074308°

16/03/23 11:43 AM GMT +05:30



G. Kalvikkarasi

Dr. G. KALVIKKARASI

PRINCIPAL

DHARMAMURTHI RAO BAHADUR
CALAVALA CUNNAN CHETTY'S HINDU COLLEGE
PATTABIRAM, CHENNAI-600072.



GPS Map Camera

Pattabiram, Tamil Nadu, India

DHAMAMURTHY RAO BAHADUR CUNNAN CHETTY BLOCK, FOOD CORPORATION OF INDIA-PATTABIRAM, Deena Dayalan Nagar, Pattabiram, Tamil Nadu 600054, India

Lat 13.121417°

Long 80.0741°

28/03/23 02:36 PM GMT +05:30

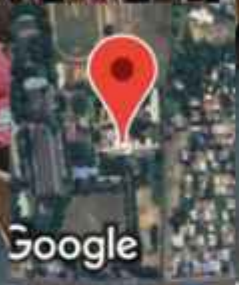

Google



GPS Map Camera

Pattabiram, Tamil Nadu, India

CUNNAN RUBY JUBILEE BLOCK, FOOD CORPORATION OF INDIA-PATTABIRAM, Deena Dayalan Nagar, Pattabiram, Tamil Nadu 600054, India

Lat 13.12162°

Long 80.073356°

14/07/23 03:34 PM GMT +05:30



Google



G. Kalvikkarasi

Dr.G. KALVIKKARASI

PRINCIPAL

DHARMAMURTHI RAO BAHADUR
CALAVALA CUNNAN CHETTY'S HINDU COLLEGE
PATTABIRAM, CHENNAI-600072.



GPS Map Camera

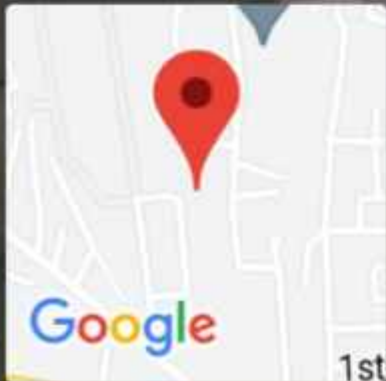

Pattabiram, Tamil Nadu, India

CUNNAN RUBY JUBILEE BLOCK, FOOD CORPORATION OF INDIA-PATTABIRAM, Deena Dayalan Nagar, Pattabiram, Tamil Nadu 600054, India

Lat 13.121807°

Long 80.073153°

06/09/22 05:23 PM

Measurement
Return
ER

CHARACTERISTICS OF
DERIVATIVE MARKET
INSTRUMENTS
DITYA KUMAR SINGH

GPS Map Camera

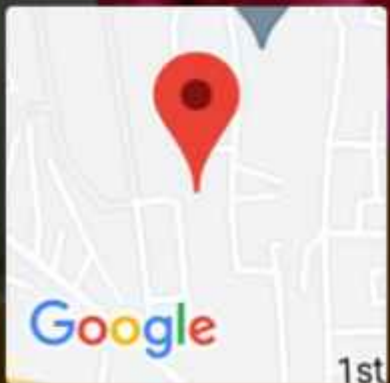

Pattabiram, Tamil Nadu, India

CUNNAN RUBY JUBILEE BLOCK, FOOD CORPORATION OF
INDIA-PATTABIRAM, Deena Dayalan Nagar, Pattabiram, Tamil Nadu 600054,
India

Lat 13.12182°

Long 80.073169°

06/09/22 05:26 PM

III B.A English

CCB-12

 GPS Map Camera

BRaille

CUNNAN AUDITORIUM Hindu College, Pattabiram, Tamil

Nadu 600054, India

Lat 13.121588°

Long 80.073317°

01/03/23 03:12 PM GMT +05:30

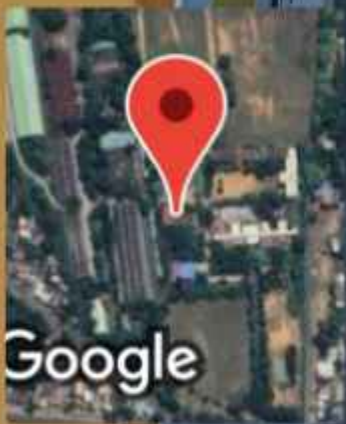



GPS Map Camera

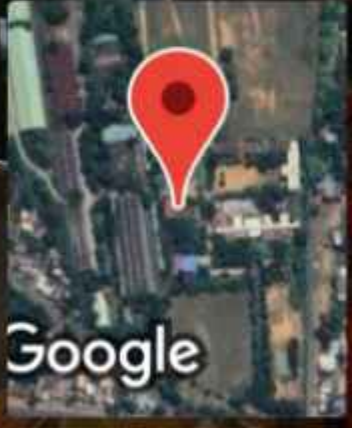

BRILLE
CUNNAN AUDITORIUM Hindu College, Pattabiram, Tamil
Nadu 600054, India
Lat 13.121588°
Long 80.073317°
01/03/23 03:14 PM GMT +05:30



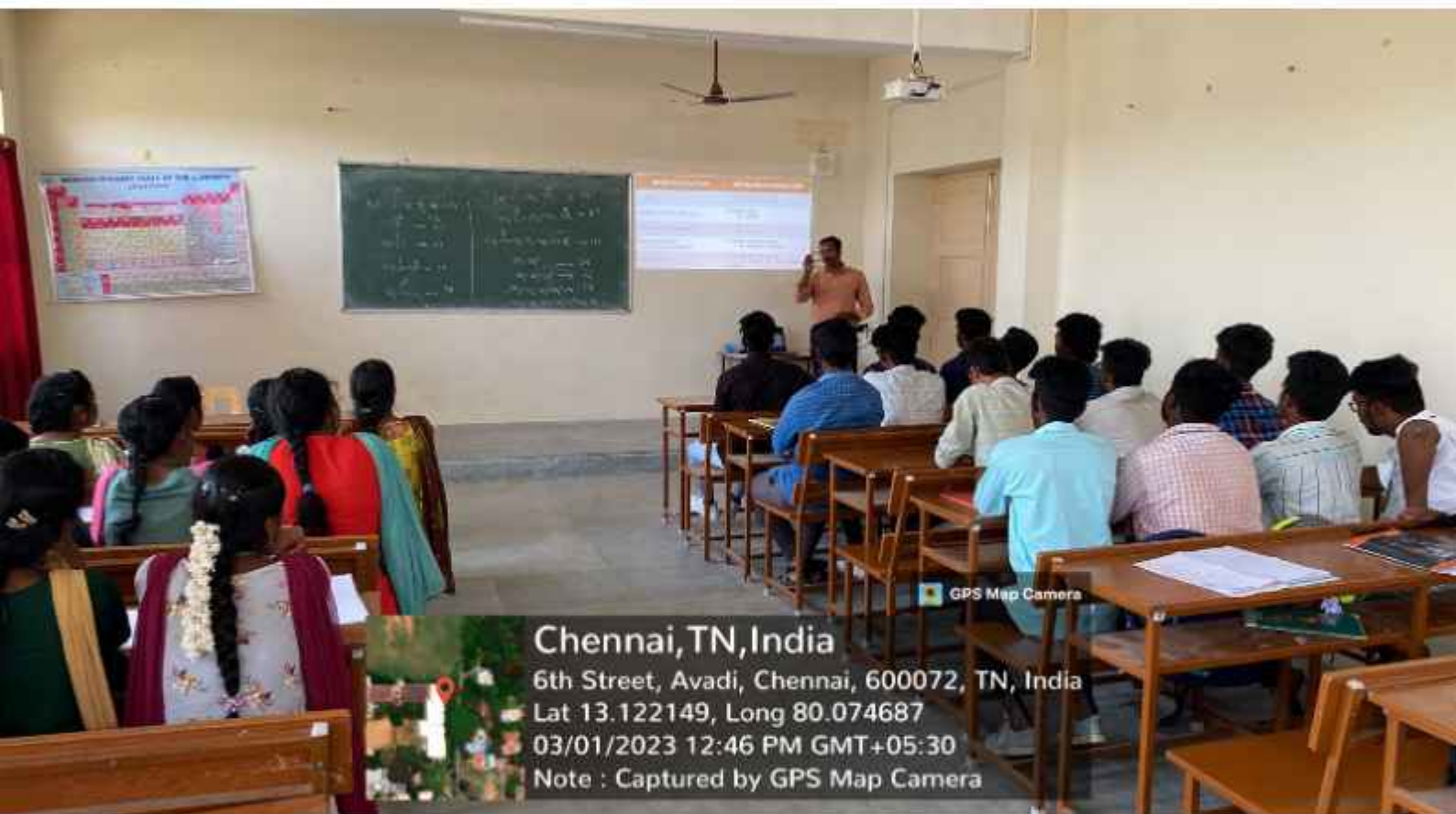

Chennai, TN, India

6th Street, Avadi, Chennai, 600072, TN, India

Lat 13.122149, Long 80.074687

03/01/2023 12:46 PM GMT+05:30

Note : Captured by GPS Map Camera



 GPS Map Camera

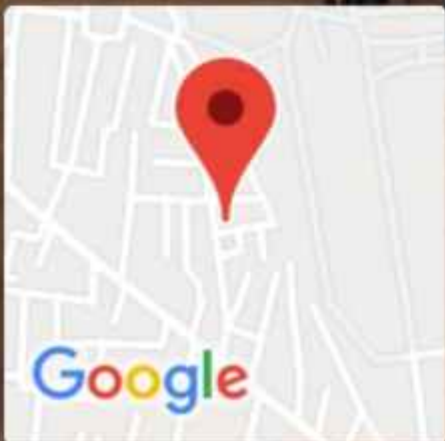

Pattabiram, Tamil Nadu, India

9, Vinayagar kovil St, Deena Dayalan Nagar,
Pattabiram, Tamil Nadu 600072, India

Lat 13.123088°





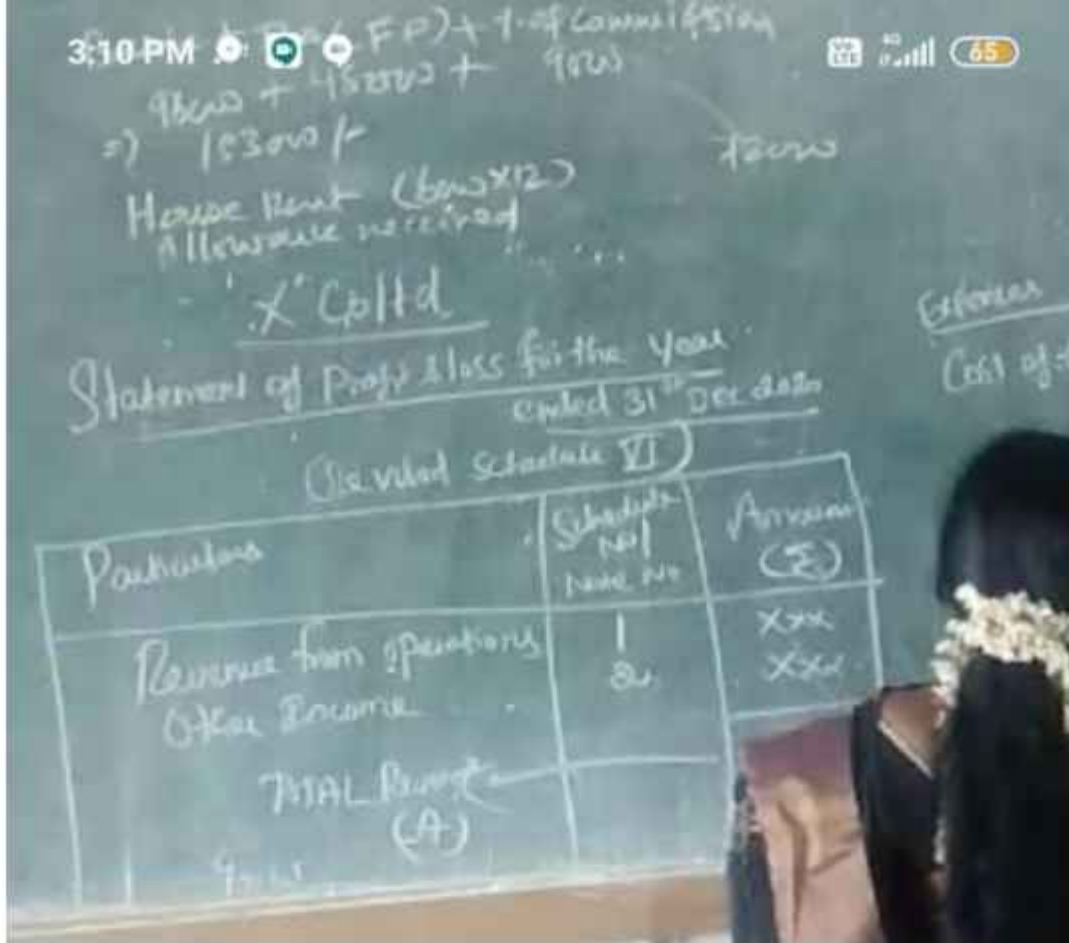



Long 80.07043°

26/10/21 03:52 PM



(69)





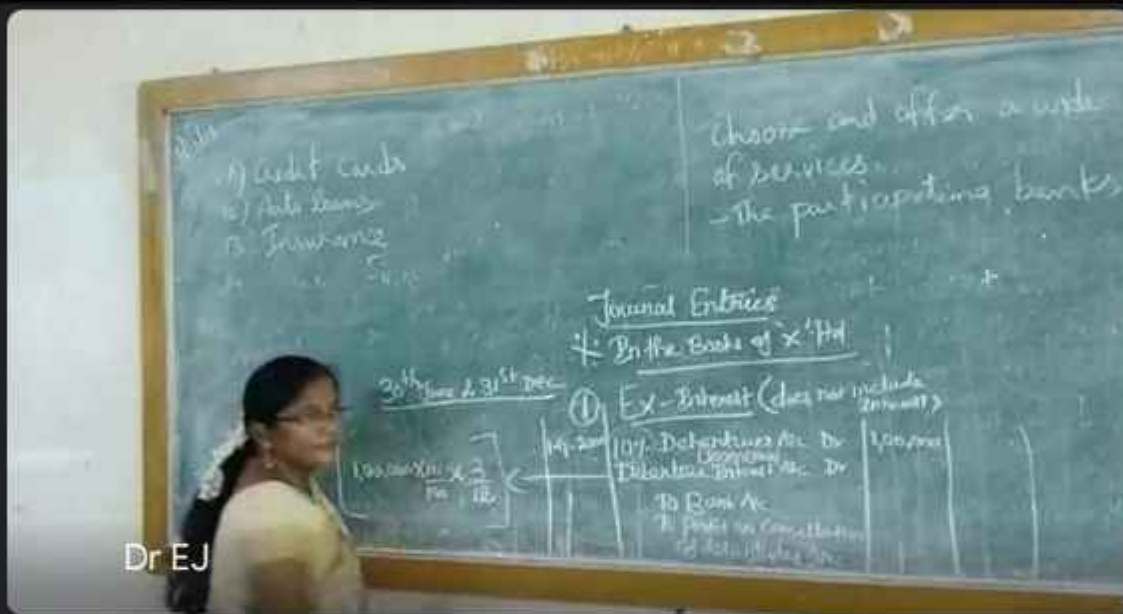

- 
20AF141 Dharshini. E (You)

- 
20AF209 Karthikeyan S

>
- 
Dr EJ

>
- 
20Af216 Raghul Ram

>

Others in the meeting (65)



Dr EJ

-  You
-  Mounica
-  Prasanna
-  65 others





Pattabiram, Tamil Nadu, India

CUNNAN RUBY JUBILEE BLOCK, FOOD CORPORATION OF INDIA-PATTABIRAM, Deena Dayalan Nagar, Pattabiram, Tamil Nadu 600054, India

Lat 13.122218°
Long 80.072984°
28/04/22 11:13 AM

GPS Map Camera

3.EQUITY MUTUAL FUNDS:

Equity mutual funds invest the pooled money majority in stock of different companies

Hence equity mutual funds have an inherent higher market risk.

Factors like earnings, revenue forecast, management changes and company economic policy impact price movements and returns.

Returns from the equity funds have high fluctuation.



GPS Map Camera

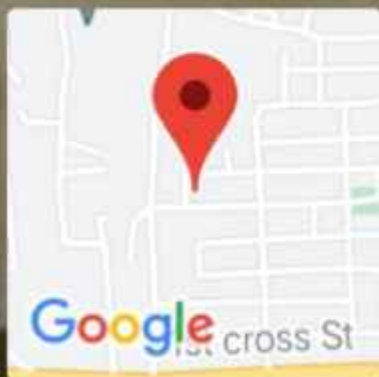

Pattabiram, Tamil Nadu, India

81, 5th Cross St, Modern City, Deena Dayalan Nagar,

Pattabiram, Tamil Nadu 600054, India

Lat 13.121499°

Long 80.075319°

26/08/22 12:54 PM



**SWAPS
&
IT'S TYPES**

15/09/2022 12:48

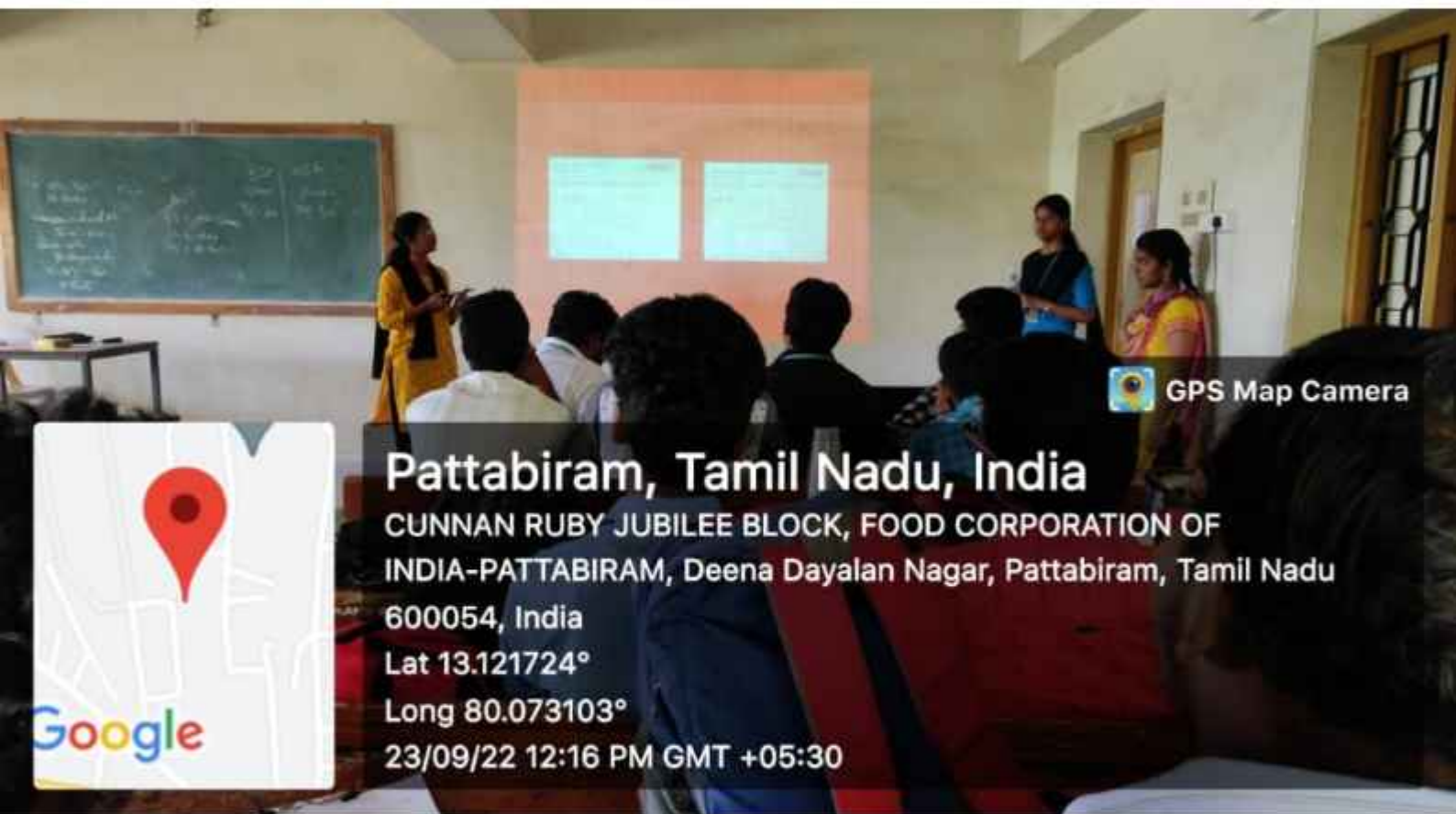

 GPS Map Camera



Pattabiram, Tamil Nadu, India

CUNNAN RUBY JUBILEE BLOCK, FOOD CORPORATION OF
INDIA-PATTABIRAM, Deena Dayalan Nagar, Pattabiram, Tamil Nadu

600054, India

Lat 13.121724°

Long 80.073103°

23/09/22 12:16 PM GMT +05:30

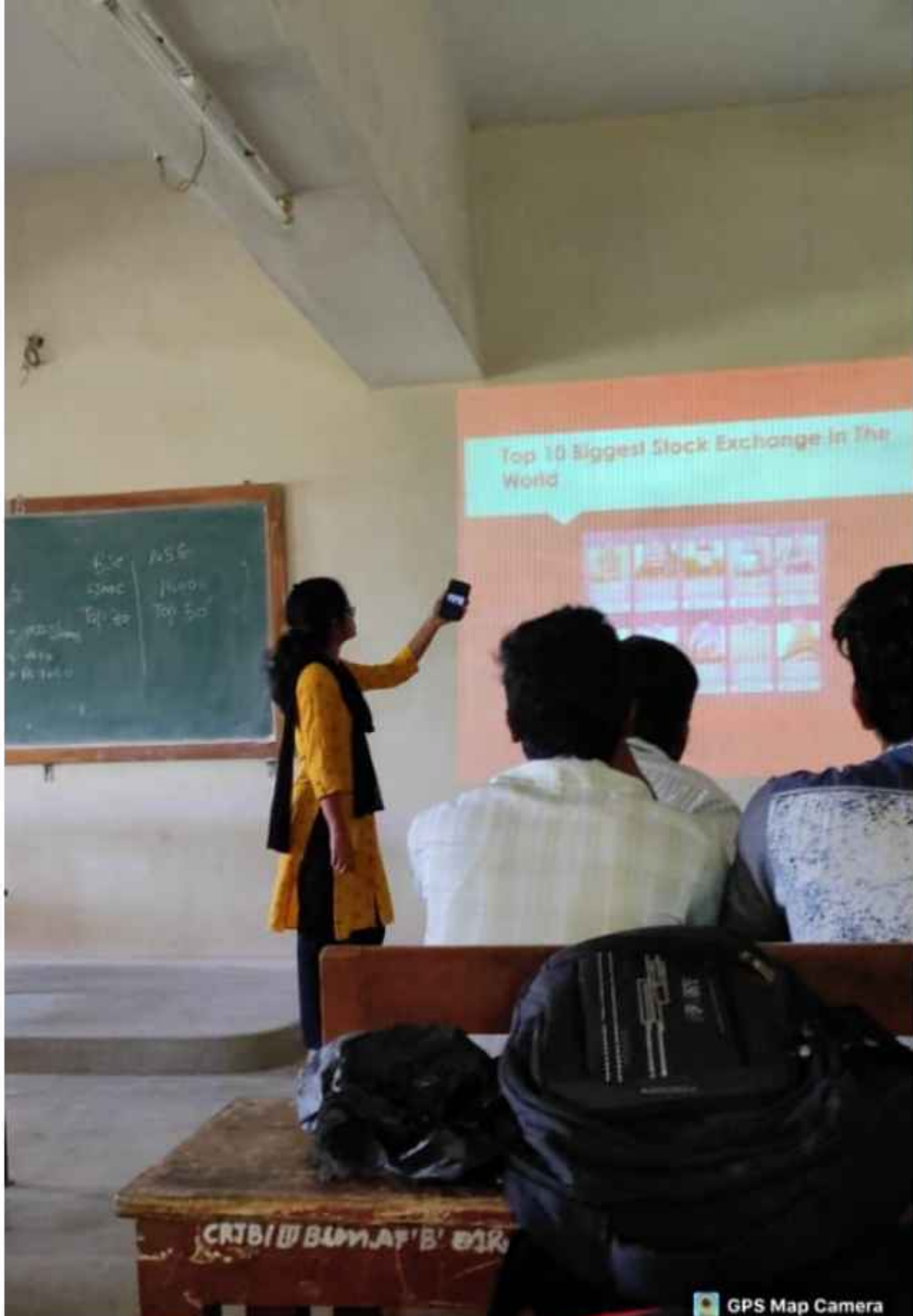

Top 10 Biggest Stock Exchange In The World



Handwritten notes on a chalkboard, including 'NSE', 'NYSE', 'Top 10', and 'Top 50'.

GPS Map Camera

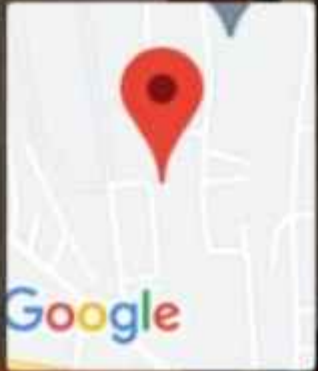

Pattabiram, Tamil Nadu, India

CUNNAN RUBY JUBILEE BLOCK, FOOD CORPORATION OF INDIA-PATTABIRAM, Deena Dayalan Nagar, Pattabiram, Tamil Nadu 600054, India

Lat 13.121726°

Long 80.073087°

23/09/22 12:12 PM GMT +05:30



1. **...**
 2. **...**
 3. **...**
 4. **...**
 5. **...**
 6. **...**
 7. **...**
 8. **...**
 9. **...**
 10. **...**

GPS Map Camera

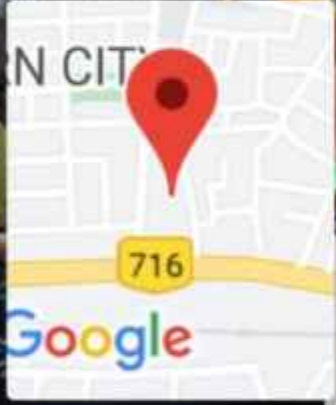

Pattabiram, Tamil Nadu, India
 43CH+38W, Deena Dayalan Nagar, Pattabiram, Tamil Nadu
 600054, India
 Lat 13.12014°
 Long 80.078444°
 27/09/22 01:38 PM GMT +05:30



 GPS Map Camera

Pattabiram, Tamil Nadu, India

7, Anna Nagar Main Rd, Modern City, Deena Dayalan Nagar,
Pattabiram, Tamil Nadu 600072, India

Lat 13.119113°

Long 80.078112°

24/09/22 01:26 PM GMT +05:30

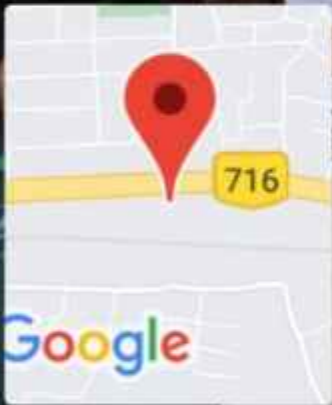



 GPS Map Camera

Pattabiram, Tamil Nadu, India

439C+MW5, NH 716, Pattabiram, Tamil Nadu

600072, India

Lat 13.11924°

Long 80.072176°

02/03/23 03:25 PM GMT +05:30





 GPS Map Camera



Pattabiram, Tamil Nadu, India

7, Thiruvalluvar nagar, Indian Air Force Rd, Deena

Dayalan Nagar, Pattabiram, Tamil Nadu 600072, India

Lat 13.120682°

Long 80.071808°

02/03/23 03:25 PM GMT +05:30



Conclusion:
To establish a complete and healthy system
for the common good of society
we need to eliminate
CORRUPTION

 **GPS Map Camera**

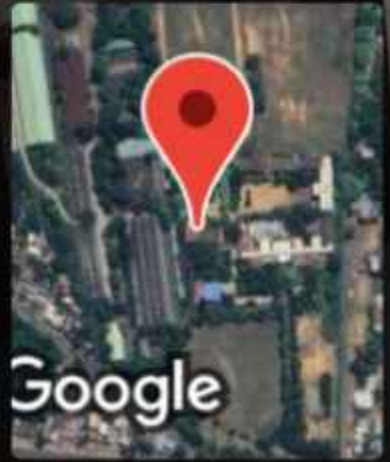

Pattabiram, Tamil Nadu, India
CUNNAN RUBY JUBILEE BLOCK, FOOD CORPORATION
OF INDIA-PATTABIRAM, Deena Dayalan Nagar, Pattabiram,
Tamil Nadu 600054, India
Lat 13.1216°
Long 80.073302°
02/03/23 03:25 PM GMT +05:30



 **GPS Map Camera**

Pattabiram, Tamil Nadu, India

Indian Air Force Road, 40, Indian Air Force Rd, Deena Dayalan Nagar, Pattabiram, Tamil Nadu 600072, India

Lat 13.121322°

Long 80.070779°

02/03/23 03:25 PM GMT +05:30





GPS Map Camera

Pattabiram, Tamil Nadu, India

CUNNAN RUBY JUBILEE BLOCK, FOOD CORPORATION OF INDIA-PATTABIRAM, Deena Dayalan Nagar, Pattabiram, Tamil Nadu 600054, India

Lat 13.121602°

Long 80.073301°

02/03/23 03:24 PM GMT +05:30





GPS Map Camera



Pattabiram, Tamil Nadu, India

CUNNAN RUBY JUBILEE BLOCK, FOOD CORPORATION OF INDIA-PATTABIRAM, Deena Dayalan Nagar, Pattabiram, Tamil Nadu 600054, India

Lat 13.121602°

Long 80.073303°

02/03/23 03:24 PM GMT +05:30

(2.3.2)

Details of ICT tools

E library



The department has uploaded 170 Ebooks as digital library in the department computer which students have been using for reference and exams. E Books on Indian History, World History and Tamil Nadu history have been classified and arranged

Kahoot quiz competition and E quiz



kahoot quiz was arranged by the department as a inter department quiz competition in which nearly hundred students participated. Indian history and general knowledge were used for framing questions



G. Kalinraj

PRINCIPAL,
DHARMAMURTHI RAO BHADUR CALAVALA CUNNAM
CHETTY'S HINDU COLLEGE
DHARMAMURTHI NAGAR, PATTABIRAM,
CHENNAI - 600 072.

Power point presentations

The staff of the department has been using Power point presentations for the benefit of students, for better understanding and for visual presentation.



C. Srinivasan
PRINCIPAL,
DHARMAMURTHI RAO BAHADUR DALAVALA CUNNAN
CHETTY'S HINDU COLLEGE
DHARMAMURTHI NAGAR, PATTABIRAM,
CHENNAI - 600 072.



Stream

Classwork

People

Grades

Customize

B.Com 23-26



Announce something to your class



K. Devadharshini

Jul 24, 2023



Authority and Responsibility

By K. Devadharshini

M. Nisha

S. Sugitha

R. Divya



Authority and Responsi...



Add class comment...



Bharathkumar Srinivasan

Jul 19, 2023



Planning Unit Fully

By Bharathkumar



Manoj Kumar
David Jonathan
Akash Kumar

 PLANNING.pdf



Add class comment...



Jivana Y jeevana
Jul 19, 2023



Y Jansi
Network Technologies

 Network Technologies



Add class comment...



S.Vasantha Kumaran
Jul 19, 2023



My name is S .Vasantha Kumaran this is my assignment

 Drive file



Add class comment...



Gokul M
Jul 19, 2023



Gokul.M





Add class comment...



Surendar D
Jul 19, 2023



Surendar.D



Staffing_202363_13510....



Add class comment...



Rogan
Jul 19, 2023



Rogan



Staffing_202363_13510....



Add class comment...



Lakshaya
Jul 19, 2023



Directing by N. Lakshaya



Directing_202361_2012...



Add class comment...





Karthi keya
Jul 19, 2023

Span of management
By: S.Karthikeya

 Span of management_2...



Add class comment...



Sayd Ameer
Jul 19, 2023

Narrow and wide span
Name sayyed ameer

 Span of management_2...



Add class comment...



Jaya Varshini
Jul 19, 2023

N.Jayavarshini

 Directing_202361_2012...



Add class comment...



Naveen Kumar
Jul 19, 2023





Add class comment...



Surendar D
Jul 19, 2023



Surendar.D



Staffing_202363_13510....



Add class comment...



Rogan
Jul 19, 2023



Rogan



Staffing_202363_13510....



Add class comment...



Lakshaya
Jul 19, 2023



Directing by N. Lakshaya



Directing_202361_2012...



Add class comment...



K. Akash kumar

 PLANNING_202362_204...



Add class comment...



Santhosh Zap
Jul 19, 2023

Span of Management
By K.Santhosh

 Span of management_2...



Add class comment...



B. Santhosh Kumar
Jul 19, 2023

Types of Organisation Structure
By b. Santhosh Kumar



Add class comment...



p.mohana priya
Jul 19, 2023

mohana priya

 Organigram.mom





Add class comment...



Udayakumar Jayaraman
Jul 19, 2023



Management by exceptions
By Vaishalee



Add class comment...



Amareswar J
Jul 19, 2023



Types of Organisation Structure
By Amar



Add class comment...

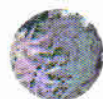

Remona
Jul 19, 2023



Management by exceptions
By Remona



Add class comment...



Madhu Madhu
Jul 19, 2023



R Hemalatha
R Hemalatha





Janani
Jul 19, 2023



Janani

Selection



Add class comment...



Vinodha
Jul 19, 2023



A.Vinodha

Mind Map_202362_2136...

Mind Map_202362_2131...



Add class comment...



Elakkiya
Jul 19, 2023



A.Elakkiya

Recruitment



Add class comment...



G. Kalimuthu
PRINCIPAL,
DHARMAMURTHI RAO RAJADUR, CALAVALA CUNNAM,
CHETTI & HINDI COLLEGE
DHARMAMURTHI RAO, PATTABIRAM,
CHENNAI - 600 072.





C. Lakshminarayanan

PRINCIPAL,
CHASMAMURTHI RAO BASAVANUR CALAVALA CUNJIAN
CHETTIYER HINDU COLLEGE
DHARMALINGESWARAN, PATTABURAM,
CHENNAI - 602 072.



ICT - விளக்கக் காட்சியுடன் வகுப்பு நடைபெறுதல் - நாள் 21-09-2023

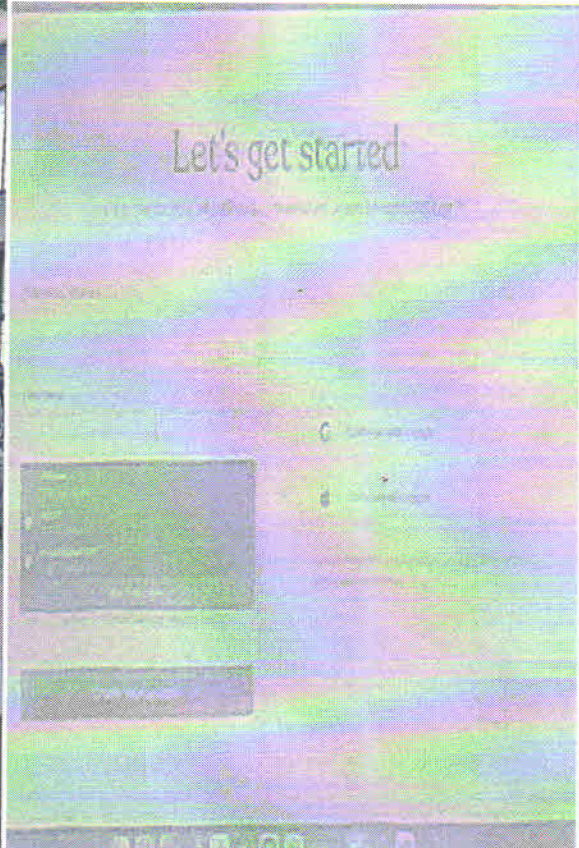



Chats



Gop



All

Unread

Groups



CHATS

**G Gopika**

Ok mam

4/29/2024

CONTACTS

**Gopi**

நில்லா உலகம் நிரம்பா வா...

**Gopi**

Busy

**Saranyagopal**

Never ever give up....

GROUPS IN COMMON



பன்னாட்டுக் கருத்... 08:45

Saranyagopal is also in this gro...



2 நிமிட பேச்சுப் ... 2/15/2024

G Gopika is also in this group



கணித் தமிழ்ப் பேரவை

G Gopika is also in this group



Your personal messages are end-to-end encrypted



See more chat history on the app

Get WhatsApp for Windows



G Gopi...



Syncing older messages. Click to see progress.

4/25/2024

தேம்பாவணி.pdf

8 pages • PDF • 112 kB



12:16 ✓

உடும்பு பேசிய படலம்.pdf

5 pages • PDF • 178 kB



13:05 ✓

Ok mam 13:15

4/29/2024

Document (7) (14).pdf

8 pages • PDF • 122 kB



11:41 ✓

Document (7) (15).pdf

10 pages • PDF • 81 kB



11:44 ✓

Ok mam 14:14



Type a message



109

Chats



sha



All

Unread

Groups

Online Tamil tutor
Yesterday

Shame

Thursday

Ok akka



Shamala BA E... 4/29/2024

Reacted to: "Docum..."



Dhakshan Kat... 4/27/2024

0:01



Shasun confer... 4/26/2024

+91 97875 49308: * பிரே...



Usha

4/24/2024



Nisha Hc

3/11/2024



Akshaya B.com 2/19/2024

You reacted to: "Co..."



Atshaya

2/14/2024

Atshaya uses a defa...



shakthi Hc

1/1/2024

+91 6379 759 106 changed...

CONTACTS



Abilasha Radio



See more chat history

on the app

Get WhatsApp for Windows



Shamala B...



4/25/2024

தேம்பாவணை.pdf

8 pages • PDF • 112 kB



12:16 ✓✓

உடும்பு பேசிய படலம்.pdf

5 pages • PDF • 178 kB



13:05 ✓✓

Nandri Amma

16:10

4/29/2024

1) சிலப்பதிகாரம்

2) சூளாமணி

3) மீனாட்சியம்மை பிள்ளைத்தமிழ் 10:59

Amma ithuku notes anupunga ma 11:00

Document (7) (14).pdf

8 pages • PDF • 122 kB



11:41 ✓✓

நன்றி அம்மா

11:42

Document (7) (15).pdf

10 pages • PDF • 81 kB



11:44 ✓✓



Type a message





Chats



Non



All Unread



Groups

CHATS



No... 4/3/2024
+91 76393 2...



NON TAM...



Non Tamil

MESSAGES

Suja Id Friday
Model-2010 registr...

Vijayakumar... Thursday
Model-2010 registratio...

Your personal messages are end-to-end encrypted

See more chat history on the app
Get WhatsApp for Windows



NonTamil 2023-24
Dr., French, Roshini, +91 6374 ...



+91 99403 67132 3/26/2024

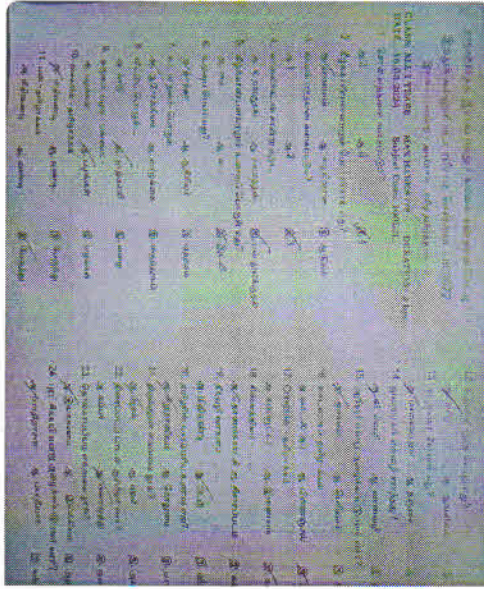

13:52

+91 99403 67132

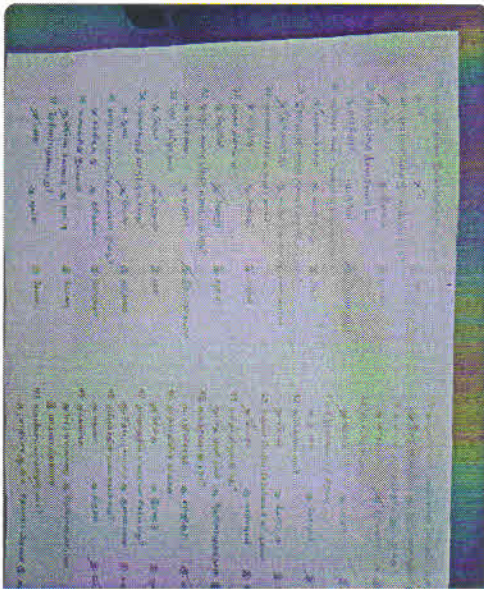

13:53

4/3/2024



+91 76393 21580
where is the class mam 13:07



Dr. Lakshmi
Ill economics class room 13:09



Type a message



109

Chats

பேச்சுப் போட்டி
Dillybabu, Dr., Lakshmi, Le...

← பேச்சுப்போ X



All Unread



Groups

MESSAGES

"யாதும் ஊ... 3/23/2024
+91 85089 06053: உ ...Dr. Lakshmi 3/13/2024
போட்டி நடத்துபவர்: ...பேச்சுப் போ... 1/3/2024
Dr.: தமிழ்த் துறை நடத்...[Click here to get older messages from your phone.](#)

1/3/2024



Dr. Lakshmi

தமிழ்த் துறை நடத்தும் போட்டிகள்

நேரம்: காலை 10:00 மணி

நாள்: 05.01.2023

இடம்: தமிழ்த் துறை

கவிதை: தையலை உயர்வு செய்

கட்டுரை: நலிந்தவர் மேம்பட நல்லறம்
புரிந்த நல்லாள்

பேச்சுப்போட்டி: மாதர் அறம்

14:31

See more chat
history on the
app
Get WhatsApp
for Windows

Type a message





Chats



← பேச்சுப் ×



All Unread



Groups

CHATS



பே... 3/4/2024
Dr.: Photo



2 ... 2/15/2024
+91 86681 5...



பே... 1/3/2024
Dr.: தமிழ்த் ...

MESSAGES

"யாதும் ... 3/23/2024
+91 85089 06053: உ.

Dr. Lakshmi 3/13/2024
போட்டி நடத்துபவ...

+91 93424 ... 2/13/2024
✓ Follow this link to j...

பேச்சுப் ... 1/3/2024
Dr.: தமிழ்த் துறை ந...

Your personal messages

See more chat history on the app Get WhatsApp for Windows



பேச்சுப் போட்டி குழு
Dillybabu, Dr., Lekha, Sangavai...



Click here to get older messages from your phone.

3/4/2024



Dr. Lakshmi
Forwarded



19:37



Type a message

Principal,
DHARMAMURTHI RAO BAHADUR CALAVALA CUNNU
CHETTY'S HINDU COLLEGE
DHARMAMURTHI NAGAR, PATTABIRAM,
CHENNAI - 600 072.



தருமலூர்த்தி இராய்க்கார் கல்வா கண்ணன் செட்டி இந்துக்கல்லூரி

தேசியத் துறைமுகக் குழுவின் B+ தகுதி பெற்றது
தருமலூர்த்தி நகர், பட்டாங்குளம், சென்னை - 600 072.
கூடுதல் - 1

On 10/08/23
Staff circular
2
Jeevants

தமிழ்த்துறை மற்றும் தமிழ் இணையக் கல்விக் கழகம்
இணைந்து நடத்தும்
கணித்தமிழ்ப் பேரவை - பயிலரங்கம்

நாள்: 18.08.2023 நேரம்: காலை 10.00 மணி இடம்: தருமலூர்த்தி கண்ணன் அறை

ஹேவ்றுபுரை

க. பேயி

துறைத்தலைவர், தமிழ்த்துறை

தலைமையுரை

முனைவர் க. கல்விக்கரசி
முதுவர்

பயிற்றுநர் உரை

திரு. கல்லீர் ஜாகீர்

VGLUG Volunteer - Lead Android Engineer @ Remitbee.



அமர்வு - 1

தமிழ் மென்பொருள் உருவாக்கப் பயிற்சி

அமர்வு - 2

தமிழ்க் குறுஞ்செயலி உருவாக்கப் பயிற்சி

நன்றியுரை

முதுமுனைவர் க.லட்சுமி

அனைவரும் வருக !!!

தமிழ்த்துறைப் பேராசிரியர்கள் மற்றும் கணித்தமிழ்ப் பேரவை மாணவர்கள்

க. பேயி

க.மு.சங்கவை

அனைத்தமிழ்ப்பேரவை

முனைவர் க. கல்விக்கரசி

முதுவர்

திரு M. வெங்கடேசபெருமாள்

செயலர்

அறங்காவலர் குழுவினர்

திரு. ரமேஷ் சித்தரல்லா, தலைவர் திரு. M.V. கன்னையச் செட்டி, அங்குள்ள அறங்காவலர் திரு. C.வெங்கடாசலம்

திரு. M. வெங்கடேச பெருமாள், கணினி செயலர் டாக்டர். பிரவீன் தெல்லகலா

திரு. R. பாலாஜி குப்தா திரு. G சந்திரமோகன் திரு. B. கௌதம்

2008/1/4 Comm. V. No. 18/12/23

STAFF ORDER NO : / STAFF CIRCULAR Dt/NOTICE No:

Teaching staff

Dr.Smt. G.K. _____

Ms. K.B. _____

Smt.S.M.S. S.S.

Dr.Smt. K.L. [Signature]

Dr.Smt. M.K.S. [Signature]

Sri R.B.S. R.B.S.

Dr.Smt. T.M.G. T.M.G.

Dr.S.B.S. S.B.S.

Dr.Smt.N.J.S. [Signature]

Dr.Smt.S.P. [Signature]

Dr.R.J. [Signature]

Dr.AVI [Signature]

Dr.M.S. [Signature]

Dr.Smt.T.K. [Signature]

Smt. V.K. V.K.

Sri V.V. [Signature]

Dr.S.V.M. [Signature]

Dr.Smt.V.S. [Signature]

Sri S.S. [Signature]

Dr.N.M. [Signature]

Ms. MH. [Signature]

Sri L.H.K. [Signature]

Smt. N.K. [Signature]

Dr.Smt.A.I. [Signature]

Dr.Smt.C.Y. [Signature]

Dr.M.J.N. [Signature]

Dr.Smt.K.B.S. [Signature]

Dr.Smt.R.J.S. [Signature]

Dr.Smt.R.R. [Signature]

Dr.R.S.P. [Signature]

Dr.S.S.K. [Signature]

Dr.G.B. [Signature]

Dr.Smt.D.L. _____

Dr.Smt.Z.B. [Signature]
18/12/23

Dr. K.S. _____

Dr. M.K. [Signature]

Teaching staff (Management Appointees)

Dr.Smt. C.M. _____

Smt. D.P. _____

Sri S.A. [Signature]















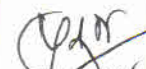





Sri V.D.R. [Signature]

Ms.D.D.R. [Signature]

Sri M.M. [Signature]

To

All Classes

CLASS	I YEAR	II YEAR	III YEAR
B.A.HISTORY			
B.A.ECONOMICS			
B.A.ENGLISH			
B.A.TELUGU			
B.COM.CORP.SEC.			
B.Sc. MATHEMATICS			
B.COM			

தருமமூர்த்தி இராவ் பகதூர் கலவல கண்ணன் செட்டி இந்துக்கல்லூரி
பட்டாபிராம், சென்னை - 600072 (சுழற்சி -1)

தமிழ்த்துறை மற்றும் தமிழ் இணையக் கல்விக்கழகம்

இணைந்து நடத்தும்

கணித்தமிழ்ப் பேரவை- பயிலரங்கம்

நாள்:18.08.2023 நேரம்: காலை 10:00

- தமிழ்த்தாய் வாழ்த்து மாணவர்கள்
- வரவேற்புரை பேராசிரியர் க.பேபி
தமிழ்த்துறைத்தலைவர்
- தலைமையுரை முனைவர்க. கல்விக்கரசி,
முதல்வர்
- சிறப்பு விருந்தினருக்குச் சிறப்புச் செய்தல்
- அறிமுகவுரை பேராசிரியர் ச.மு.சங்கவை, உதவிப்பேராசிரியர்
- சிறப்புரைஉரை : திரு. கலீல்ஜாகிர்
இணைய வல்லுநர்
- நன்றியுரை முதுமுனைவர் கா.இலட்சுமி, உதவிப்பேராசிரியர்
- நாட்டுப்பண்

கணினித் தமிழ்ப் பேரவை - பயிலரங்கம் 18.08.2023



C. Valimurthy
PRINCIPAL,
DHARMAMURTHI RAO BHADUR CALAYALA CUNNAM
CHETTY'S HINDU COLLEGE
DHARMAMURTHI NAGAR, PATTABIRAM,
CHENNAI - 600 072.

பட்டாபிராம் இந்து கல்லூரியில் கணினி தமிழ் பயிற்சி



பட்டாபிராம், தரும மூர்த்தி இராவ் பகதூர் கலவல கண்ணன் செட்டி இந்து கல்லூரி தமிழ்துறை (கழற்சி- கணினித் தமிழ் பேரவை சார்பில் "ஆண்டராய்ட் தொழில் நுட்பமும் பயன்பாடுகளும்" என்னும் பொருளில் ஒரு நாள் பயிலரங்கம் நடைபெற்றது. கணினி தமிழ் வல்லுநர் கல் ஜாகீர் ஆண்டராய்டு கருவிகள், வளப்படுத்தும் கருவிகள், ஜாவா, கோட்லின் உள்ளிட்ட கணினி மொழிகளின் பயன்பாடுகள் குறித்தும் தொலை நோக்கிலான இணைய சிந்தனைகளை வளர்க்கும் நோக்கிலும் மாணவர்களுக்கு பயிற்சியளித்தார். கல்லூரி முதல்வர் முனைவர் க.கல்விக்காசி தலைமையேற்று பயிற்சி வகுப்பை தொடங்கிவைத்தார். முன்னதாக தமிழ் துறை தலைவர் பேராசிரியர் க.பேரி வரவேற்று பேசினார். மாணவர்கள் கணினியை தமிழ் மொழியிலேயே பயன்படுத்தும் நோக்கிலும் இணைய வளத்தெடுக்கும் நோக்கிலும் இந்து கல்லூரியில் கணினித்தமிழ்ப் பேரவை, தமிழ் இணைய கழகத்தின் நிதிநல்கையுடன் கடந்த ஆண்டு தொடங்கப்பட்டது. மாணவர்களுக்கான கணினி தமிழ் பயிற்சிகளை இப்பேரவை தொடர்ந்து வழங்கி வருகிறது. 125 மாணவர்கள் பேரவையில் உறுப்பினர்களாக இருந்து இப்பயிற்சியை பெறுகின்றனர்



PRINCIPAL,

DHARMAMURTHI RAO BHANDUR CALAVALA CUNNAM
CHETTY'S HINDU COLLEGE

DHARMAMURTHI NAGAR, PATTABIRAM.

பின்னூட்டப் படிவம்

கணித்தமிழ்ப் பேரவை - பயிலரங்கம்

பயிலரங்கப் பொருண்மை:

ஆண்ட்ராய்டு மென்பொருள்

நாள்:

18.08.2023

இன்றைய நிகழ்வின்
சிறப்பு விருந்தினர் திரு
கல்ல ஜாகிர் பயிற்சி
உரை

Copy

82 responses

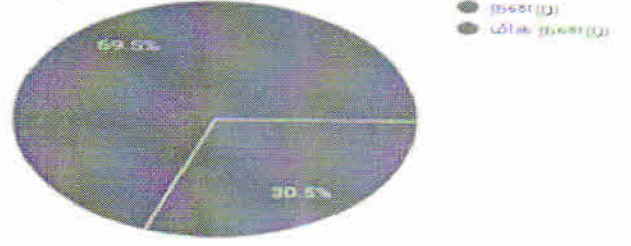

ஆண்ட்ராய்டு
மென்பொருள் குறித்த
புரிதலை இந்நிகழ்வு
ஏற்படுத்தியதா?

Copy

82 responses

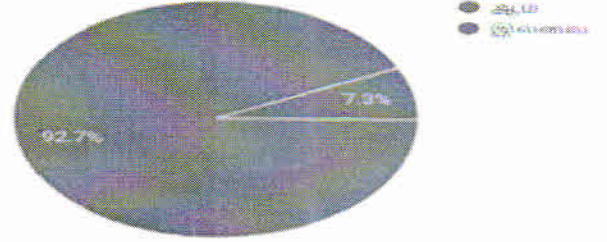

இணையத்தில்
சந்தைப்படுத்தல்
பயனுள்ளதா?

Copy

82 responses

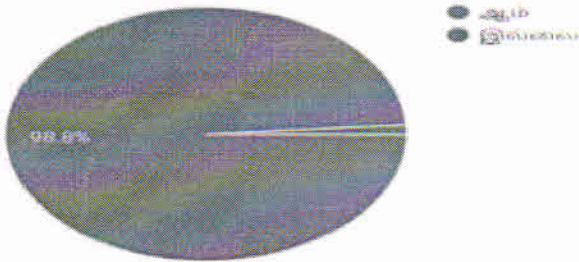

கணினி மொழி சார்ந்த
மென்பொருளை
அறிவது பணிவாய்ப்பை
ஏற்படுத்தும்

Copy

81 responses

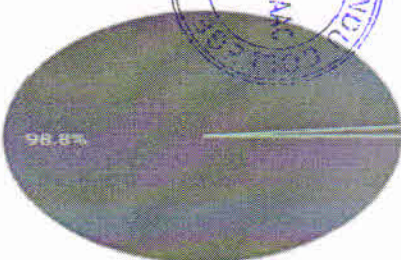

ஆம்
இல்லை

PRINCIPAL,
DHARMAMURTHI RAO BANGALURU CALAVALA GUNNAR
CHETTY'S COLLEGE
DHARMAMURTHI RAO BAR, PATTABIRAM,
CHENNAI - 600 072.

பயிலரங்க
ஒருங்கிணைப்பு

Copy

82 responses

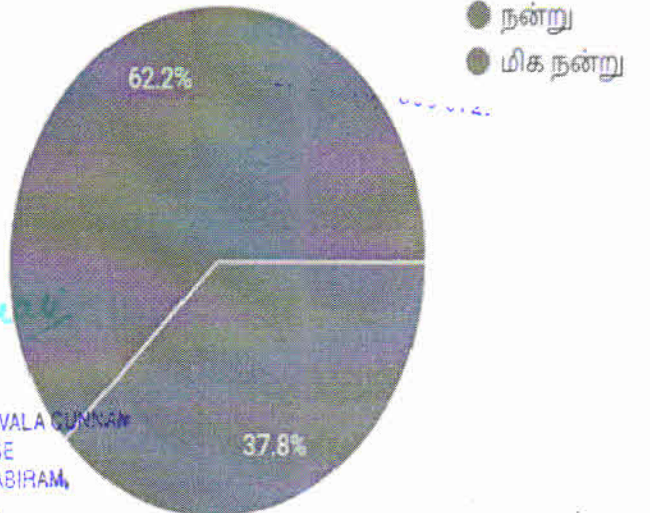



தரும மூர்த்தி இராஜமதுர் கல்வியை கண்ணன் செட்டி இந்துக்கல்லூரி

தேசியத் தமிழ் கல்வித் துறையின் B+ தகுதி பெற்றது
தருமமூர்த்தி நகர், உட்பலியூர், சென்னை - 600 072.

கட்டிடம் - 1

Circular to students & Staff

Cell
30/1/23

தமிழ்த்துறை மற்றும் தமிழ் இணையக் கல்விக் கழகம்

இணைந்து நடத்தும்

கணித்தமிழ்ப் பேரவை - கணினித் திருவிழா

நாள்: 31.08.2023 நேரம்: காலை 10.00 மணி இடம்: கண்ணன் அரங்கம்

வரவேற்புரை

க. பேயி

துறைத்தலைவர், தமிழ்த்துறை

தலைமை

முனைவர் க. கல்விக்கரசி
முதல்வர்

சிறப்புரைகள்

திரு. 'நீச்சல்காரன்' இராஜாராமன்

தொழில்நுட்ப வல்லுநர், முதலமைச்சர் கணினித்தமிழ் விருதாளர்.

திரு. மு.சு. அருண்குமார்

ஆய்வு வளமையர், கணித்தமிழ்ப்பேரவை
& தமிழ்ப் பெருங்களுக்கியத் திட்டம்
தமிழ் இணையக் கல்விக்கழகம், சென்னை

நன்றியுரை

முதுமுனைவர் மு.கஸ்தூரி

அனைவரும் வருக !!!

தமிழ்த்துறைப் பேராசிரியர்கள் மற்றும் கணித்தமிழ்ப் பேரவை மாணவர்கள்

க. பேயி

ச.மு.சங்கவை

முனைவர் க. கல்விக்கரசி
முதல்வர்

முனைவர் க. கல்விக்கரசி
முதல்வர்

திரு M. வெங்கடேசபெருமாள்

செயலர்

அறங்காவலர் குழுவினர்

திரு. ரமேஷ் சித்தரல்லா, நமஸ் திரு. M.V. கன்னையச் செட்டி, அழகட்டை அறங்காவலர் திரு. C. வெங்கடாசலம்

திரு. M. வெங்கடேச பெருமாள், கல்லூரி செயலர் பாக்டர். பிரவீன் தெல்லகுவா

திரு. R. யாலாஜி குப்தா திரு. G. சந்திரமோகன் திரு. B. கௌதம்

கணித்தமிழ்ப் பேரவை - கணினித் திருவிழா

தரும மூர்த்தி இராவ் பகதூர் கலவல கண்ணன் செட்டி இந்துக்கல்லூரியின் தமிழ்த்துறை(சுழற்சி-1), தமிழ் இணையக் கல்விக் கழகத்தின் நிதிநல்கையுடன் கணித்தமிழ்ப் பேரவையைத் தொடங்கி, நூற்றி இருபத்தைந்து மாணவர்களை உறுப்பினர்களாகக் கொண்டு, திறம்பட இணையத் தமிழ்ப் பணி ஆற்றிவருகிறது. நமது கல்லூரிக் கணித்தமிழ்ப் பேரவை சார்பில் மாணவர்கள் கணினியைத் தமிழ் மொழியிலேயே பயன்படுத்தும் நோக்கிலும் இணையத் தமிழை வளர்த்தெடுக்கும் நோக்கிலும் 31.08.2023 அன்று கணினித் திருவிழா நடைபெற்றது. இந்நிகழ்வின் ஒருங்கிணைப்பாளர் தமிழ்த்துறைத் தலைவர் பேராசிரியர் க.பேபி அவர்கள் வரவேற்புரை வழங்கினார். தமிழ்த்துறைப் பேராசிரியர் முதுமுனைவர் கா.இலட்சுமி அறிமுகவுரை வழங்கினார். பன்னாட்டு நிறுவனத்தின் கணினித் தொழில்நுட்ப வல்லுநரான திரு. நீச்சல்காரன் ராஜாராமன் அவர்கள் "தமிழ் இணையதளம் உருவாக்கம்" என்னும் பொருண்மையில் இணையதளம் உருவாக்கத்தின் பயன்கள், உருவாக்கும் முறை, மொழி நோக்கிலான பயன்பாடு, பல்லாடகத் தொடர்பு, பணிவாய்ப்பு குறித்து இணையம் வழியாக மாணவர்களோடு கலந்துரையாடி, மாணவர்களின் ஐயங்களுக்கு வழிகாட்டினார்.

தமிழ் இணையக் கல்விக் கழகத்தின் ஆய்வு வளமையரான திரு மு.சு. அருண்குமார் சிறப்பு விருந்தினராய்க் கலந்து கொண்டு மாணவர்களுக்குத் தமிழ் இணையதளங்கள் பற்றிய அறிமுகமும் கணினி வழி தமிழை அணுகும் முறைகள், பயன்பாடுகள் குறித்தும் விளக்கினார். இணையச் சிந்தனைகளை வளர்க்கும் நோக்கில் மாணவர்களுக்குத் தமிழ்க் கணிமை போட்டிகள்,

1. வலைப்பக்கம்(webpage) அல்லது வலைப்பூ (Blog) உருவாக்கம்
தலைப்பு: உன்னால் முடியும்
2. போன்மி (memes) உருவாக்கம்
தலைப்பு: சந்திராயன்-3
3. காட்சி நிகழ்த்துகை (ppt) உருவாக்கம்
தலைப்பு: கணினி- தலைமுறைகள்
4. முப்பரிமாண மாதிரி வடிவமைப்பு (3D models)
தலைப்பு: தமிழர் கட்டிடக்கலை
5. குறும்படம் (shortfilm) உருவாக்கம்
தலைப்பு: தோன்றின் புகழோடு தோன்றுக

என்னும் பன்முக தன்மையில் நடத்தப்பட்டன. பரிசு பெற்ற மாணவர்களுக்குச் சிறப்பு விருந்தினர் பரிசுகள் வழங்கிச் சிறப்பித்தார். கணினி மாதிரிகள் கண்காட்சி கணினி திருவிழாவில் இடம் பெற்றது நிகழ்வின் நிறைவாக, தமிழ்த்துறைப் பேராசிரியர் முதுமுனைவர் மு.கஸ்தூரி நன்றியுரை வழங்கினார். கல்லூரியின் தமிழ்த் துறைப் பேராசிரியர்கள் கலந்து கொண்டு ஊக்கப்படுத்தினர். மாணவர்களின் இணையப் பயன்பாட்டுத் திறத்தை வளர்ப்பதற்கு இக்கணினித் திருவிழா நல்களமாய் அமைந்தது.

தமிழ்க் கணிமை - போட்டிகள்

- தனிநபர் போட்டிகள்

1. வலைப்பக்கம்(webpage) அல்லது வலைப்பூ (Blog) உருவாக்கம்

தலைப்பு: உன்னால் முடியும்

- ஒரு வலைப்பக்கத்தை உருவாக்கி, உன்னால் முடியும் என்ற தலைப்பில் ஒரு பத்தியை தமிழ் அல்லது ஆங்கிலத்தில் பதிவிடல்.

2. போன்மி (memes) உருவாக்கம்

தலைப்பு: சந்திராயன்-3

- தமிழ் அல்லது ஆங்கிலத்தில் போன்மி உருவாக்குதல்

3. காட்சி நிகழ்த்துகை (ppt) உருவாக்கம்

தலைப்பு: கணினி- தலைமுறைகள்

- தமிழ் அல்லது ஆங்கிலத்தில் உருவாக்குதல்

4. முப்பரிமாண மாதிரி வடிவமைப்பு (3D models)

தலைப்பு: தமிழர் கட்டிடக்கலை

- தமிழர் கட்டிடக்கலையை எடுத்துரைக்கும் நோக்கில் முப்பரிமாணத்தில் உருவ மாதிரியை உருவாக்குதல்.

- குழு போட்டி

5. குறும்படம் (shortfilm) உருவாக்கம்

தலைப்பு: தோன்றின் புகழோடு தோன்றுக

- தமிழ் அல்லது ஆங்கிலத்தில் ஒரு நிமிடத்தில் குறும்படம் உருவாக்குதல்.
(குழுவில் மூவர் முதல் ஐவர் வரை பங்கேற்கலாம்.)

கணிளித் தமிழ்ப் பேரவை - திருவிழா 31.08.2023



C. Kalimuthu
PRINCIPAL,
DHARMAMURTHI RAO BAHADUR CALAVALA CUNNAM
CHETTY'S HINDU COLLEGE
DHARMAMURTHI NAGAR, PATTABIRAM,
CHENNAI - 600 072.

கணித்தமிழ்ப் பேரவை- கணினித் திருவிழா

நாள்: 31.08.2023
20 responses

இன்றைய நிகழ்வின்
சிறப்பு விருந்தினர் திரு.
நீச்சல்காரன் ராஜாராமன்
உரை
20 responses

Copy

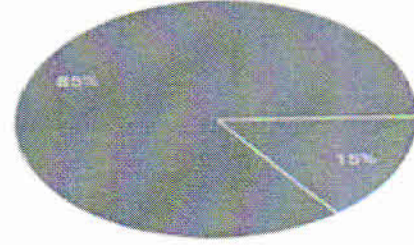

● நன்று
● மிக நன்று

இணையத் தமிழ்
மென்பொருள் குறித்த
புரிதலை இந்நிகழ்வு
ஏற்படுத்தியதா?
20 responses

Copy

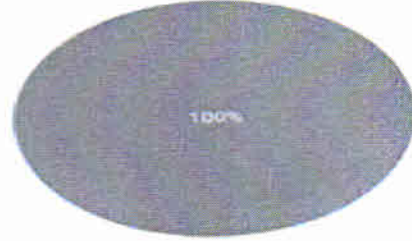

● ஆம்
● இல்லை

இணையப் போட்டிகள்
20 responses

Copy

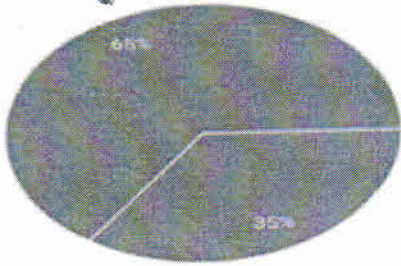

● நன்று
● மிக நன்று

இணைய வலைத்தளம்
குறித்த புரிதலை
இந்நிகழ்வு
ஏற்படுத்தியது
20 responses

Copy

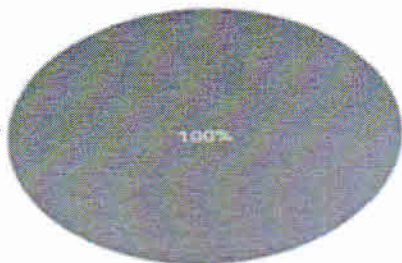

● ஆம்
● இல்லை

பயிலரங்க
ஒருங்கிணைப்பு,
கருத்துக்கள் குறித்த
கருத்த
20 responses

Copy

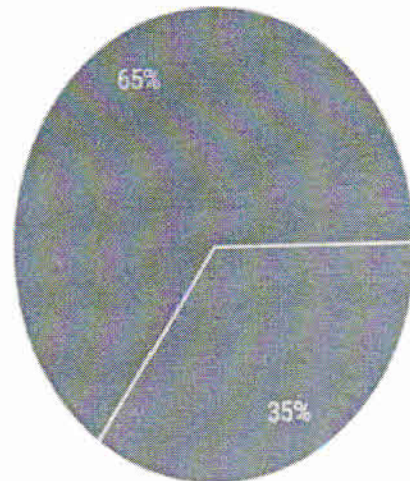

● நன்று
● மிக நன்று



**DHARMAMURTHI RAO BAHADUR
CALAVALA CUNNAN CHETTY'S HINDU COLLEGE**
"LINGUISTIC (TELUGU) MINORITY STATUS
CONFERRED BY THE GOVERNMENT OF TAMIL NADU"
(SHIFT 1 - GOVT. AIDED)



Re-accredited by NAAC with B+ Grade - Affiliated to University of Madras
DHARMAMURTHI NAGAR, PATTABIRAM, CHENNAI - 600 072.
Phone: 044-26850621
www.drbecchinducollege.ac.in E-mail: hc1@drbecchinducollege.edu.in

Sri M. Venkatesaperumal, B.A., F.C.A.,
Secretary

Dr.(Smt.) G. Kalvikkarasi, M.A., M.Phil., Ph.D.,
Principal

தேதி: 29.08.2023

சுற்றறிக்கை

தமிழ்த்துறை மற்றும் தமிழ் இணையக் கல்விக்கழகம் இணைந்து நடத்தும் கணித்தமிழ்ப் பேரவை சார்பில் தமிழ்க்கணிமை - போட்டிகள் 30.08.2023 அன்று நடைபெறும். அப்போட்டிகளில் பங்கு கொள்ளும் மாணவர்கள் தமிழ்த் துறையை அணுகவும்.

போட்டிகள் தொடர்பான விவரம் வ ருமாறு.

தனிநபர் போட்டிகள்

1. வலைப்பக்கம் (webpage) அல்லது வலைப்பு (Blog) உருவாக்கம்
2. போன்மி (memes) உருவாக்கம்
3. காட்சிநிகழ்த்துகை (ppt) உருவாக்கம்
4. முப்பரிமாண மாதிரி வடிவமைப்பு (3D models)

குழுபோட்டி

5. குறும்படம் (shortfilm) உருவாக்கம்

ஒருங்கிணைப்பாளர்

முதல்வர்
DHARMAMURTHI RAO BAHADUR CALAVALA
CUNNAN CHETTY'S HINDU COLLEGE
DHARMAMURTHI NAGAR,
PATTABIRAM, CHENNAI - 600 072.

வரிசை எண்	பெயர்	வகுப்பு	பயிற்சிபெறும் மீட்டல்
43547	ஆ. ம. வித்திகா	I st B. Com (General)	PPT, Blog, Word press
43566	ம. வேதகார்ஜினி	I st B. Com (General)	Blog, Word press, PPT
43342	பா. கிருத்திகா	I st B. Com (CS)	PPT
43338	ஜாய் மென்சி. ரா	I st B. Com (C.S)	PPT
43341	ம. சீர்த்திகா	I st B. Com (CS)	PPT
43326	ஆ. அர்ச்சுனா	I st B. Com (CS)	PPT
43327	சு. தார்ஜினி	I st B. Com (CS)	Wordpress, PPT
43321	சு. சிசுர்சன்	I st B. Com (CS)	Wordpress.
43320	நா. சீனிவாசன்	I st B. Com (CS)	PPT, Blog
43302	செ. ஜெ. பரஞ்சுலா	I st B. Com (C.S)	Wordpress, PPT
42112	சு. சந்திரா	II nd B. A ELO	PPT, Memes
42102	செ. சந்திரா சிவா	II nd B. A ELO	Wordpress, Memes.
42125	ஆ. அர்ச்சுனா	II nd B. A ELO	PPT,
42124	M. ஆபிரீன் பாஷா	II-nd B. A ELO	PPT
42136	P. Gopika	II-nd B. A ELO	PPT, MEMES
42414	செ. அஸ்வதி	II - B. Sc. Maths	Blog, PPT
42464	செ. வைஷ்ணவி	II - B. Sc. Maths	Webpage or Blog
42427	செ. சாரதா தேவியா	II - B. Sc. Maths	Blog, PPT PPT.
42436	மா. நித்யா	II - B. Sc. Maths	Webpage, PPT.
42441	மா. மீனாட்சி	II B. Sc Maths	Web page, PPT
42423	செ. சந்திரா	II B. Sc Maths	Webpage, PPT
42416	மா. புவனேஸ்வரி	II BSC Maths	webpage, ppt
42416	சி. சீபிகா	I BA. English	memes
4227	செ. சந்திரா. வி	I. B.A English	Wordpress.
4231	செ. சந்திரா. சி	I. BA English	memes, PPT
434	செ. சந்திரா	III 3rd year Bsc Maths	
4468	மா. நிஷித்	III 3rd year Bsc. Math	
4403	செ. நிஷித்	III 3rd Bsc Maths	



C. Aravinthan
 PRINCIPAL,
 CHETTY'S HINDU COLLEGE,
 CHARMAMURTHI NAGAR, PATTABIRAM,
 CHENNAI - 600 072.

2.3.2.

Department Of B.Com(Ism)

ICT TOOLS

Dr. Premila Koppalakrishnan, HOD



C. Kalinay
PRINCIPAL,
DHARMAMURTHI RAO BHADUR CALAVALA CUNNAM
CHETTIYAR STREET COLLEGE
DHARMAMURTHI NAGAR, PATTASIRAM,
CHENNAI - 600 072.

Academic Year

2023-2024



Classroom > BCOM SECOND YEAR



Stream

Classwork

People

Grades



Create

All topics

REVISION

Edited Mar 19



REVISION

Posted Mar 19



QUIZ

Posted Mar 19



HOLIDAY HOMEWORK

Posted Mar 19



case study



INDIVIDUAL ASSIGNMENT ----- CA...

Due Feb 15, 11:59 PM





Stream

Classwork

People

Grades



Customize

BGE-CSC19 ENTREPRENEURIAL D...



Announce something to your class



premila koppalakrishnan

Apr 11



Pradhan Mantri Jan Dhan Yojana

Various subsidies provided to small-scale industriesSIDCO

Pradhan Mantri Jan Dhan Yojana

frequently repeate...

Google Slides



Add class comment...



premila koppalakrishnan

Apr 11 (Edited Apr 11)



Various subsidies provided to small-scale industries

Top Government Business Loan Schemes in India

10 Best Government Subsidies for Small Business



Top 5 Government ...

<https://groww.in/blog/to>

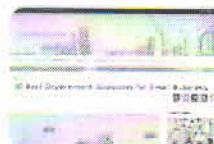

10 Best Governme...

<https://smeventure.com/>





Stream

Classwork

People

Grades



premila koppalakrishnan
Mar 30 (Edited Mar 30)



PREVIOUS YEAR QUESTION PAPER



NOV-2017_CPM3D...
PDF



NOV-2018_CPM3D...
PDF



APR-2018_CPM3D...
PDF



APR-2019_CPM3D...
PDF



NOV-2020_CPM3D...
PDF



APR-2021_CPM3D...
PDF



2 MARKS ANSWER...
PDF



Add class comment...



premila koppalakrishnan
Mar 30



Additional notes from the book



Adobe Scan Mar 27...
PDF



Adobe Scan Mar 27...
PDF

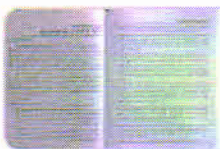

unit2.pdf
PDF



unit 3.pdf
PDF

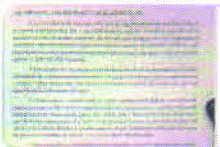

unit 4.pdf
PDF

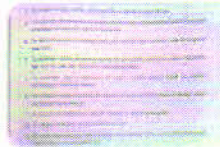

unit 5.pdf
PDF





Classroom > BGE-CSC19 ENTREPRENEURI...



Stream

Classwork

People

Grades



PDF



PDF

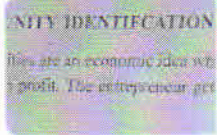

STEP IN OPPORTU...
PDF

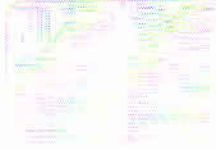

PROJECT REPORT ...
PDF

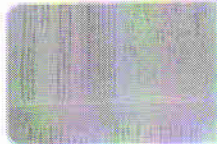

FUNCTION OF ENT...
PDF



OBJECTIVES OF SI...
PDF



ROLE OF ENTREPR...
PDF



TYPES OF ENTREP...
PDF



CONTENT OF EDPs...
PDF



CONCEPT OF ENT...
PDF

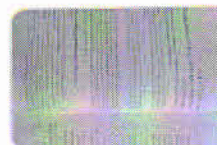

ENTREPRENEURIAL...
PDF



CONTACT OF WO...
PDF



Add class comment...



premila koppalakrishnan
Mar 18



Differences between Angel Investor and Venture Capitalist



Add class comment...



premila koppalakrishnan
Mar 18



Angel investors





Stream Classwork People Grades



Add class comment...



premila koppalakrishnan
Mar 17



ROLE OF COMMERCIAL BANKS FOR THE DEVELOPMENT OF ENTREPRENEURSHIP



ROLE OF COMMER...
PDF



Add class comment...



premila koppalakrishnan
Mar 14



List of Government Schemes to Support Startups in India GOVERNMENT INITIATIVES FOR STARTUP



List Of Governmen...
<https://startuptalky.com/>



Add class comment...



premila koppalakrishnan
Mar 12



Women Entrepreneurs Shaping The Future Of India



Women Entreprene...
YouTube video • 11 minu



C. Kalinmozhi
PRINCIPAL,
DHARMAMURTHI RAO RAHADUR CALAVALA CUNNAN
CHETTIN'S ROAD, COLLEGE
DHARMAMURTHI NAGAR, PATTABIRAM,
CHENNAI - 600 072.





Stream

Classwork

People

Grades



premila koppalakrishnan
Mar 12



Entrepreneurship in young age | Vinusha M.K | TEDxKanniyakumari



At 10, this Chennai ...
YouTube video • 7 minute



Entrepreneurship i...
YouTube video • 5 minute



Add class comment...



premila koppalakrishnan
Mar 12



Top 10 Successful Young Entrepreneurs in India – 2024



Top 10 Successful Y...
<https://ponnusamykarthi>



Add class comment...



premila koppalakrishnan
Mar 12



Top 10 Indian Entrepreneurs

1. Dhirubhai Ambani

Dhirubhai Ambani(1932–2002) is an Indian businessman who started humbly by selling traditional snacks to religious pilgrims. His business soon grew, and he expanded and diversified into industries including telecommunications, power generation, information technology, consumer goods, and logistics.1

Today, Reliance Industries is India's largest private company and is listed on the Fortune 500.2 Ambani's son now runs Reliance and is one of India's wealthiest people; Mukesh Ambani, 65, is worth \$92.5 billion, according to Forbes.

2. Jehangir Ratanji Dadabhoj Tata

Jehangir Ratanji Dadabhoj Tata or JRD Tata (1904–1993) was born in Paris to Indian and French parents. He was trained as an aviator in Europe and later became India's first commercial airline pilot. Working for the family business, TATA group, he set out on his own and built TATA Airlines, which ultimately became the





Stream

Classwork

People

Grades



Add class comment...



premila koppalakrishnan

Dec 28, 2023



10 Characteristics of Successful Entrepreneurs



10 Characteristics ...

<https://online.hbs.edu/bl>



Add class comment...



premila koppalakrishnan

Dec 28, 2023 (Edited Jan 16)



Welcome back! I am sure you had a great break before joining the classroom online . It's now time to look forward to a year that makes wonderful memories.

Welcome to the Entrepreneurial Development course. Embark on a learning and entrepreneurial journey at the forefront of your aspirations.



Add class comment...



G. valinnaray
PRINCIPAL,
DHARMAMURTHI RAO BHADUR CALAVALA CUNNAM
CHETTI'S HINDU COLLEGE
DHARMAMURTHI NAGAR, PATTABIRAM,
CHENNAI - 600 072.



**DHARMAMURTHI RAO BAHADUR CALAVALA CUNNAN CHETTY'S
HINDU COLLEGE**

DEPARTMENT OF B.COM(ISM)

Information and Communication Technology

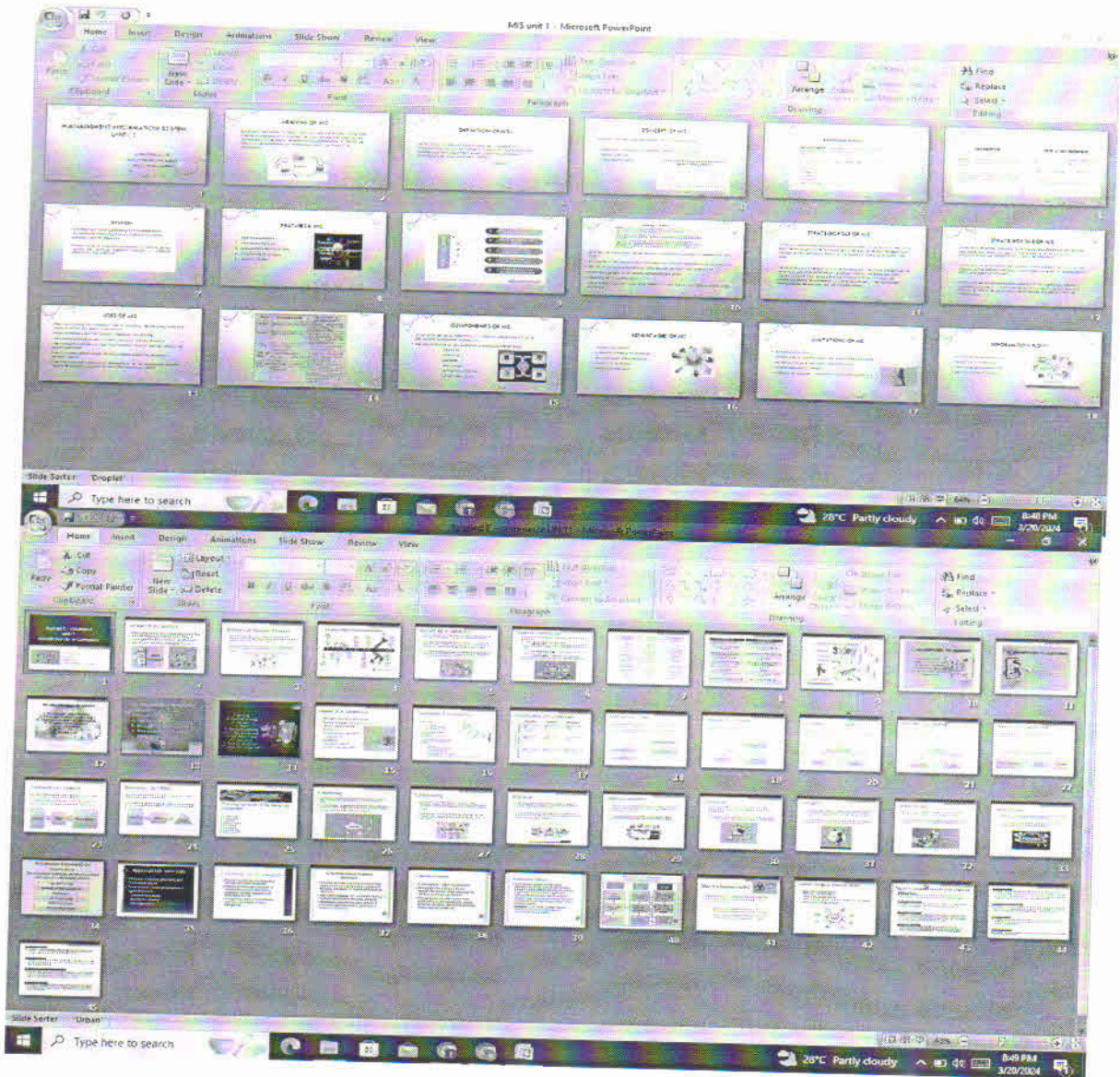

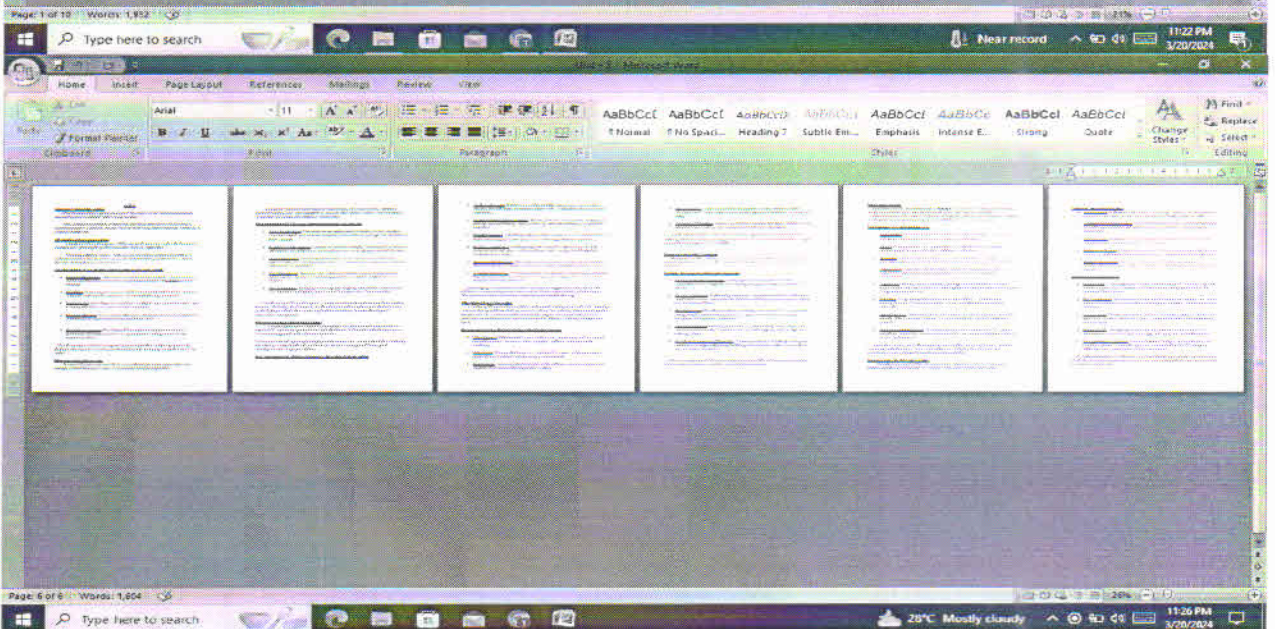
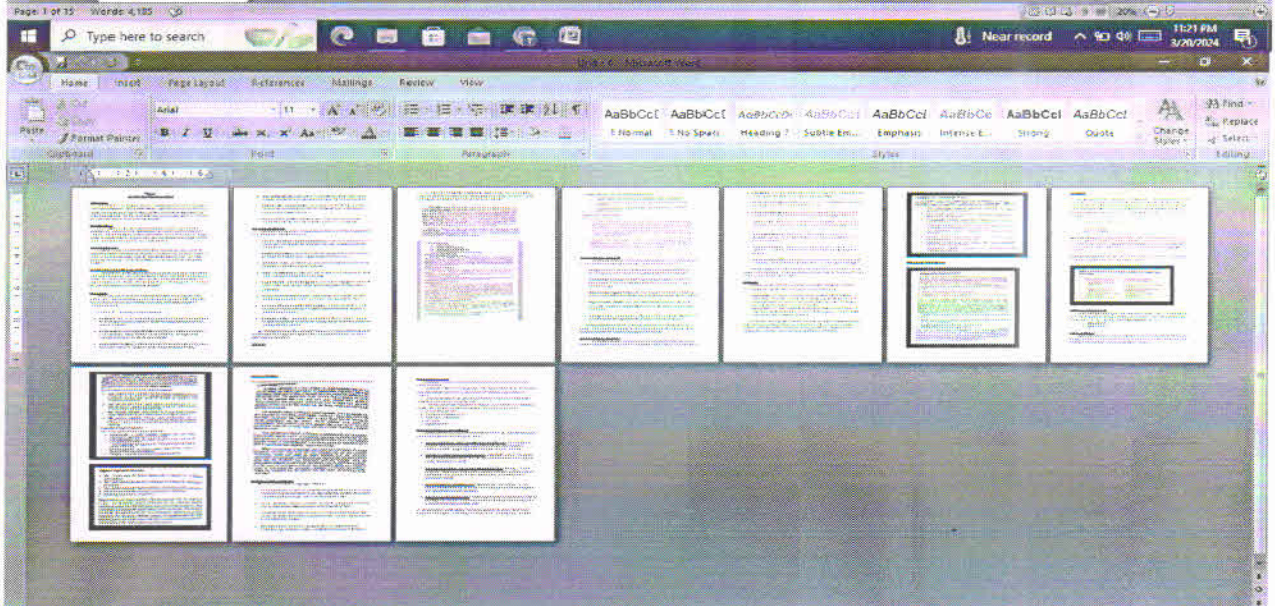
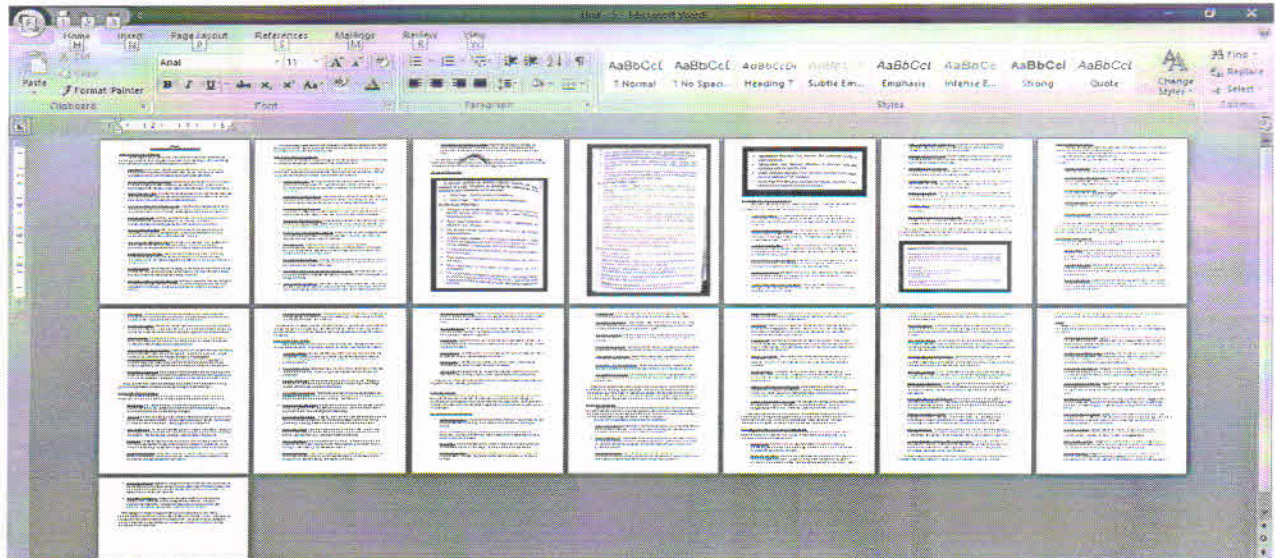

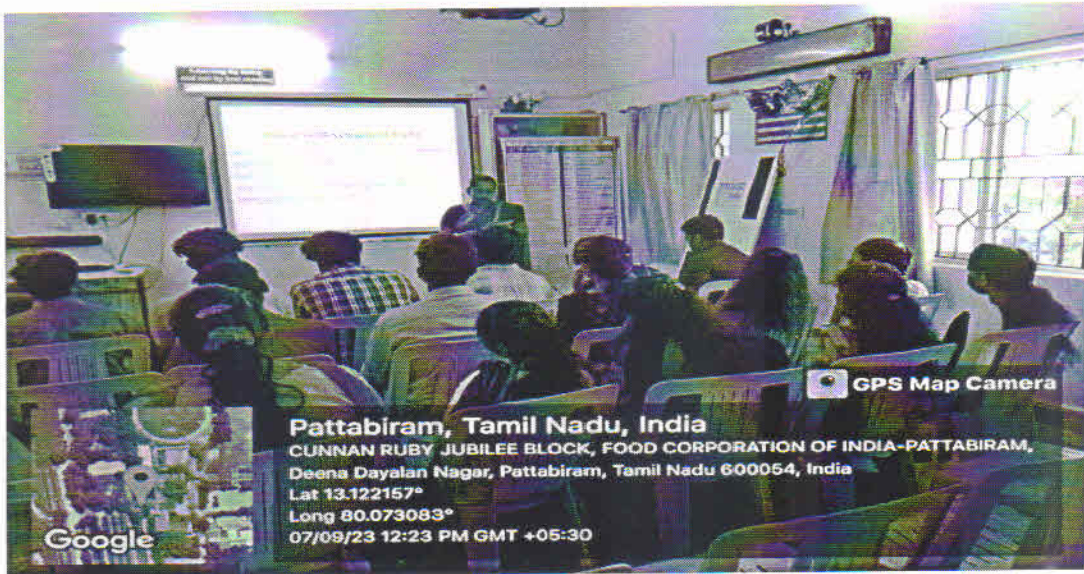

Pattabiram, Tamil Nadu, India
CUNNAN RUBY JUBILEE BLOCK, FOOD CORPORATION OF INDIA-PATTABIRAM,
Deena Dayalan Nagar, Pattabiram, Tamil Nadu 600054, India
Lat 13.122157°
Long 80.073083°
07/09/23 12:23 PM GMT +05:30

Google



Pattabiram, Tamil Nadu, India
CUNNAN RUBY JUBILEE BLOCK, FOOD CORPORATION OF INDIA-PATTABIRAM,
Deena Dayalan Nagar, Pattabiram, Tamil Nadu 600054, India
Lat 13.122157°
Long 80.073083°
07/09/23 12:23 PM GMT +05:30

Google



Pattabiram, Tamil Nadu, India
CUNNAN RUBY JUBILEE BLOCK, FOOD CORPORATION OF INDIA-PATTABIRAM,
Deena Dayalan Nagar, Pattabiram, Tamil Nadu 600054, India
Lat 13.122185°
Long 80.073132°
12/09/23 05:02 PM GMT +05:30

Google

1st B.COM ISM
50 students

B.COM 2nd year ISM
91 students

B.COM 3rd Year ISM
84 students

Teachers

Tejasveni

Students

- 23IS101Ajithkumar
- 23IS102 HARI
- 23IS103Harish
- 23IS107
- 23IS110 LOKESH.G

1st B.COM ISM

New material: Previous year question paper (November) 8:35 pm

New material: Previous year Question paper (April) 8:35 pm

New material: Unit 5 Accounting standards 8:16 pm

New material: Unit 4 - dissolution of Partnership firm 8:13 pm

Stream Classwork People

- Previous year question paper (N... Posted 8:35 pm
- Previous year Question paper (A... Posted 8:32 pm
- Unit 5 Accounting standards Posted 8:16 pm
- Unit 4 - dissolution of Partnershi... Posted 8:13 pm
- Unit 3 admission and retirement ... Posted 8:13 pm
- Unit 2 branch and departmental ... Posted 8:11 pm
- Unit 1 hire purchase and installm... Posted 8:10 pm
- Accounting standards Posted 13 Feb

Teachers

Tejasveni

Students

- Aathi shakthi 27
- Abinaya Moorthi
- Azar Ansari
- Chareeshma Sk
- Datchayani Gunaseelan

- Previous year Question paper Posted 8:22 pm
- Unit 5 Posted 8:05 pm
- Unit 1 Posted 8:05 pm
- Implementation of MIS in compa... Posted 13 Feb
- Exercise 10 - Prepare a financial ... Posted 23 Sep 2023
- Exercise 9 - Activation of interes... Posted 23 Sep 2023
- Exercise 8 - Activation of Tally in... Posted 23 Sep 2023
- Exercise 7 - Creation of payroll, ... Posted 23 Sep 2023

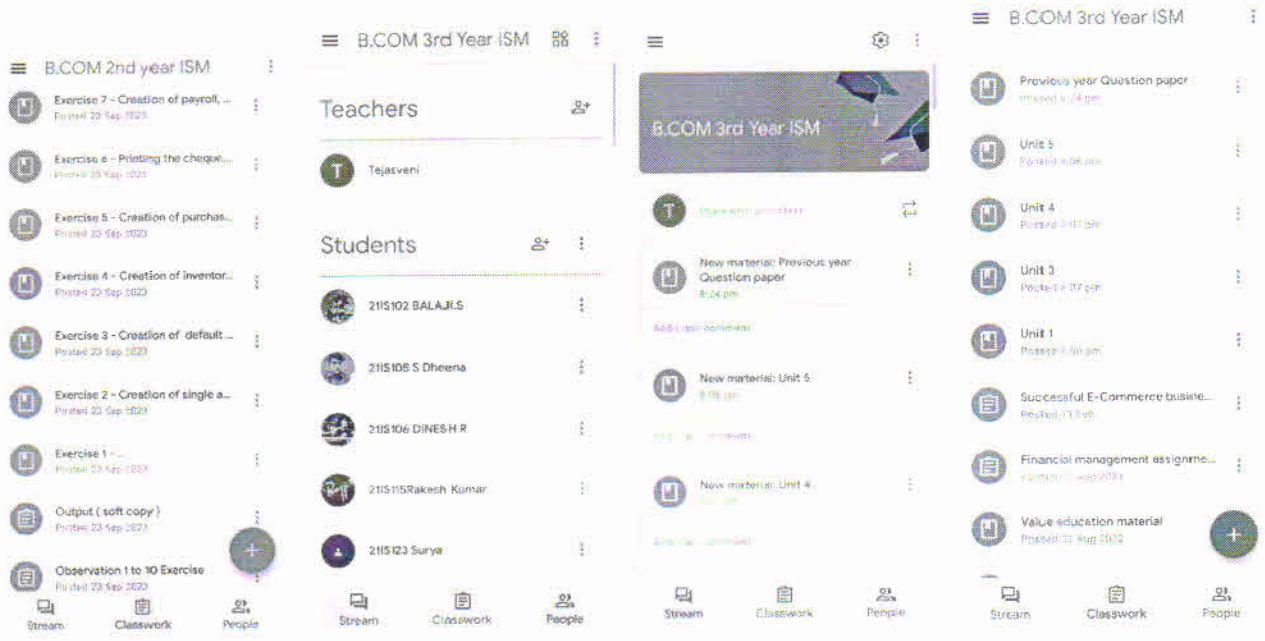

- **First year Google classroom link -**
<https://classroom.google.com/c/NjI3ODQwOTY3NzQx?cjc=xn4zjs3>
- **Second yea Google classroom link -**
<https://classroom.google.com/c/NjMzMzE1MDc2NzAw?cjc=r3c2rxi>
- **Third yea Google classroom link -**
<https://classroom.google.com/c/NjE2NjM4MjI0MTMy?cjc=brs5xrj>



G. Lakshminaray
PRINCIPAL,
 DHARMAMURTHI RADHAKRISHNAN ALAVALA CUNNAN
 CHETTY S. HINDU COLLEGE,
 DHARMAMURTHINAGAR, PATTABIRAM,
 CHENNAI - 600 072.

ICT tools



Pattabiram, Tamil Nadu, India
SCIENCE BLOCK, FOOD CORPORATION OF INDIA-PATTABIRAM, Deena Dayalan Nagar,
Pattabiram, Tamil Nadu 600054, India
Lat 13.121847°
Long 80.074155°
19/03/24 05:26 PM GMT +05:30



Prof. Indhira M. Mandey MBA, M.Phil., M.Com.
NETIMGTI Head -
Department of Business Administration (Shift 2)
Dharmamurthi Rao Bahadur Calavala Cunnan
Chetty's Hindu College,
Pattabiram, Chennai - 600 072.

G. Kalinjaray
PRINCIPAL,
DHARMAMURTHI RAO BAHADUR GALAVALA CUNNAN
CHETTY'S HINDU COLLEGE
DHARMAMURTHI NAGAR, PATTABIRAM,
CHENNAI - 600 072.

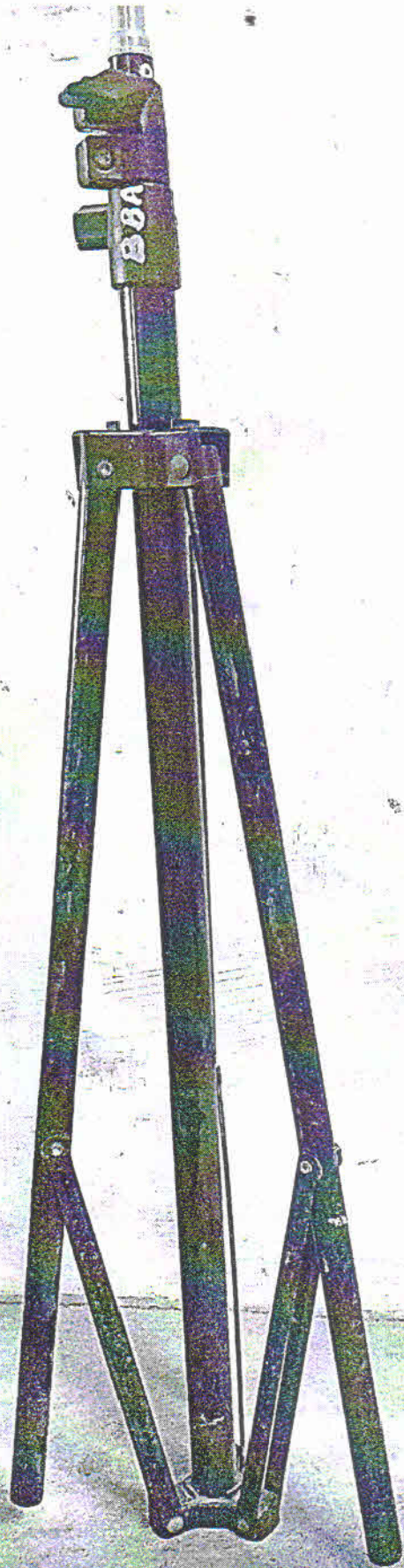

G. Valimuray

PRINCIPAL,
DHARMAMURTHI RAO BAHADUR CALAVALA CUNNAM
CHETTY'S HINDU COLLEGE
DHARMAMURTHI RAO PATTABIRAM,
CHENNAI - 600 072.



 GPS Map Camera

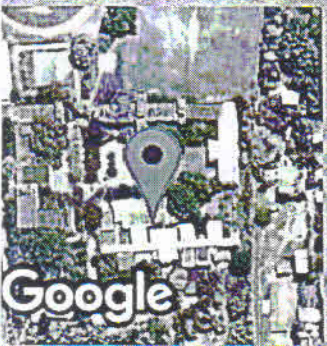

Pattabiram, Tamil Nadu, India

SCIENCE BLOCK, FOOD CORPORATION OF INDIA-PATTABIRAM, Deena

Dayalan Nagar, Pattabiram, Tamil Nadu 600054, India

Lat 13.121847°

Long 80.074155°

19/03/24 05:24 PM GMT +05:30

ICT Tools for Teaching

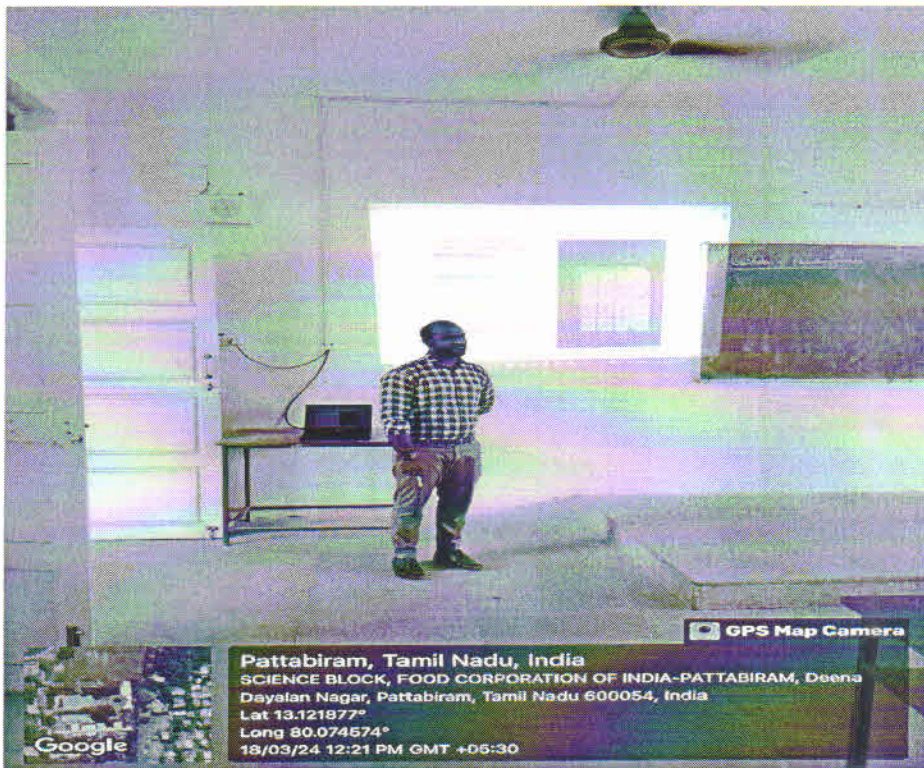

G. Vasanthakumari
PRINCIPAL,
DHARMAMURTHI RAO BAHADUR CALAYALA CUNNAM
CHETTY'S HINDU COLLEGE
DHARMAMURTHI NAGAR, PATTABIRAM,
CHENNAI - 600 072.

G. Jeyaraj
HEAD OF THE DEPARTMENT
Department of Physics
Dharmamurthi Rao Bahadur
Calavala Cunnan Chetty's Hindu College (Shift 2)
Dharmamurthi Nagar, Pattabiram, Chennai-72

2.3.2

9.3 a. - 2

DEPARTMENT OF BCOM ISM

ICT BASED TEACHING

Dr. N. Preetha

Assistant Professor

2023-2024

ODD SEMESTER

Ist year and IInd year

Google Class Room



C. Chaitanya
PRINCIPAL,
DHARMAMURTHI RAO RAJESWAR CALAVALA CUNNAN
CHETT
DHARMA
ADIRAM.
Chennai - 600072.

Teachers

0+

Preetha N

Students

48 students

0+



Actions

A-Z



A Kanimozhi



Abitha Saritha



Ajith Ajith



Anu Priya



CH. SABARISH



Hari U



Harish



Hemachandran



Jal Sakthi



K.Raksith Roshan



KarthickFF KarthickFF



Keerthana



Keerthana



Keerthi Vasan



Kevin W



Lingesh S



Lokesh Shiva



M. Vijay



Manoj Sahadaven arjunan



Mathan Mylesh



Meshak Meshak



<input type="checkbox"/>		Monika . K	⋮
<input type="checkbox"/>		Monisha A	⋮
<input type="checkbox"/>		monisha krishnan	⋮
<input type="checkbox"/>		Nesa Kumar	⋮
<input type="checkbox"/>		Nikitha	⋮
<input type="checkbox"/>		Paul Raj	⋮
<input type="checkbox"/>		PURUSHOTHAMAN .R	⋮
<input type="checkbox"/>		R Raghul	⋮
<input type="checkbox"/>		Raju Nani	⋮
<input type="checkbox"/>		Robin Son	⋮
<input type="checkbox"/>		Rohith Rohith	⋮
<input type="checkbox"/>		Rubesh Raj Kumar	⋮
<input type="checkbox"/>		Saru Vignesh	⋮
<input type="checkbox"/>		SELF BELIEF VP	⋮
<input type="checkbox"/>		Shankar S	⋮
<input type="checkbox"/>		Shayam Ganesh	⋮
<input type="checkbox"/>		Shayini ramu	⋮
<input type="checkbox"/>		Shobana Sakthi	⋮
<input type="checkbox"/>		subalakshmi Subalakshmi	⋮
<input type="checkbox"/>		Surya Prakash	⋮
<input type="checkbox"/>		Usha Nandhini K	⋮
<input type="checkbox"/>		vignesh s	⋮
<input type="checkbox"/>		Vijaya raj	⋮
<input type="checkbox"/>		yegnesshwar venkatesan	⋮
<input type="checkbox"/>		Yogalakshmi Yogalakshmi	⋮
<input type="checkbox"/>		Yogesh Yogesh	⋮



Stream Classwork People Grades



Create

All topics

Skill Enhancement Lab

Posted Oct 6, 2023

Python Record Front Page

Posted Oct 6, 2023

Python Record typing work

Due Sep 25, 2023, 11:30 AM

Pandas Tutorial

Posted Sep 24, 2023

Python previous year question paper

Posted Sep 13, 2023

Unit 5 Assignment

Due Sep 20, 2023, 11:30 AM

Unit 4 Assignment

Due Sep 19, 2023, 11:30 AM

Python Record Programs

Posted Aug 23, 2023

Python Question Bank

Posted Aug 11, 2023

Revision Test

15th nov revision Test

Due Nov 15, 2023, 5:30 PM

Today's revision test

Due Nov 24, 2023, 5:30 PM

Unit 4 Test

Due Nov 10, 2023, 2:30 PM

Unit 5 Revision Test

Unit 5 Test 10 mark and 5 mark

G Help us improve this product!



No thanks

Show question

By continuing, you agree Google uses your answers, [account](#) & [system info](#) to improve services, per our [Privacy & Terms](#).

Stream Classwork People Grades

Python ppt

Python All 5 units material

Edited Sep 1, 2023

PYTHON OBSERVATION

PYTHON PROGRAMS 7,8,9, 10

Edited Oct 4, 2023

Write next 3 programs 2

Due Jul 31, 2023, 1:45 PM

Python Record 5

Edited Jul 28, 2023

Observation first 3programs

Due Jul 17, 2023, 11:00 AM

NME PRACTICAL

Students will see this topic once work is added to it

Python observation and Record programs

Python observation

Edited Jul 28, 2023



Stream Classwork People Grades



Preetha N posted a new material: Skill Enhancement Lab
Oct 6, 2023



Preetha N posted a new material: Python Record Front Page
Oct 6, 2023



Preetha N posted a new assignment: Python Record typing work
Sep 24, 2023 (Edited Sep 25, 2023)



Preetha N posted a new material: Pandas Tutorial
Sep 24, 2023



Preetha N posted a new material: Python previous year question paper
Sep 13, 2023



Preetha N posted a new assignment: Unit 5 Assignment
Sep 13, 2023



Preetha N posted a new assignment: Unit 4 Assignment
Sep 13, 2023 (Edited Sep 13, 2023)



 Nesa Kumar
Sep 1, 2023

Finished this observation notes mam M.Nesa kumar



 Add class comment...



 Shankar S
Aug 28, 2023

I am finished my Python observation mam



 Add class comment...



Customize

I YEAR PYTHON

Announce something to your class

Preetha N posted a new assignment: Today's revision test
Nov 24, 2023

Preetha N posted a new assignment: 15th nov revision Test
Nov 15, 2023 (Edited Nov 24, 2023)

monisha krishnan
Nov 15, 2023

Monisha

K.Monisha.pdf
PDF

Add class comment...

Preetha N posted a new assignment: Unit 4 Test
Nov 10, 2023

monisha krishnan
Nov 10, 2023

Monisha.k

Monisha.K.pdf
PDF

Add class comment...

Preetha N posted a new assignment: Unit 5 Revision Test

Help us improve this product!

No thanks Show question

By continuing, you agree Google uses your answers, account & system info to improve services, per our [Privacy & Terms](#).

People Grades

Sort by last name

Nov 24, 20... Today's revision

Nov 15, 20... 15th nov revision

Nov 10, 20... Unit 4 Test

Nov 9, 2023 Unit 5 Revision

Nov 8, 2023 Unit 5 Test 10 mark

Sep 25, 20... Python Record

Sep 20, 20... Unit 5 Assignme out of 5

Sep 19, 20... Unit 4 Assignme out of 5

Class Average	N/A	N/A	N/A	N/A	N/A	N/A	3.95	4.47
A Kanmozhi	Turned in Done late	Turned in	Turned in	Turned in	Turned in	Turned in	5	5
Abitha Saritha	Missing	Missing	Turned in	Turned in	Turned in Done late	Turned in	5	5
Ajith Ajith	Missing	Missing	Missing	Missing	Turned in Done late	Missing	3 Done late	4 Done late
Anu Priya	Turned in	Turned in	Turned in	Turned in	Turned in Done late	Missing	5	5
CH. SABARISH	Turned in Done late	Turned in Done late	Turned in Done late	Turned in Done late	Turned in Done late	Turned in	5 Done late	5
Harl U	Missing	Missing	Missing	Missing	Missing	Missing	3 Done late	4 Done late
Harish	Turned in	Turned in	Turned in Done late	Turned in	Turned in Done late	Turned in	3 Done late	5
Hemachandran	Turned in Done late	Missing	Turned in	Turned in Done late	Turned in Done late	Missing	3 Done late	5
Jai Sakthi	Turned in	Turned in	Turned in	Turned in	Turned in Done late	Turned in	Missing	Missing
K.Raksith Roshan	Missing	Turned in Done late	Turned in Done late	Turned in Done late	Missing	Turned in Done late	3 Done late	5
KarthickFF KarthickFF	Missing	Missing	Missing	Missing	Missing	Missing	3 Done late	4 Done late
Keerthana	Missing	Turned in	Turned in	Turned in	Turned in Done late	Turned in	3 Done late	4 Done late
Keerthana	Turned in	Turned in	Turned in	Turned in	Turned in	Turned in	5	5
Keerthi Vasan	Missing	Turned in Done late	Turned in	Turned in Done late	Turned in Done late	Missing	Missing	Missing
Kevin W	Missing	Missing	Missing	Missing	Missing	Missing	Missing	Missing
Lingesh S	Turned in Done late	Turned in	Turned in	Missing	Turned in	Turned in	5	Missing
Lokesh Shiva	Missing	Missing	Missing	Missing	Missing	Missing	5/5 Draft	5
M. Vijay	Missing	Missing	Missing	Turned in	Turned in Done late	Missing	3 Done late	Missing
Manoj Sahadaven arjunan	Turned in Done late	Turned in Done late	Turned in	Turned in Done late	Turned in	Missing	3 Done late	4 Done late
Mathan Mylesh	Missing	Missing	Missing	Missing	Missing	Missing	Missing	Missing
Meshak Meshak	Missing	Missing	Turned in Done late	Turned in	Turned in Done late	Missing	5/5 Done late	5/5 Done late
Mohammed Yusuf	Missing	Missing	Missing	Turned in	Turned in	Missing	3 Done late	5
Monika . K	Turned in Done late	Turned in	Turned in	Turned in	Turned in	Turned in	5	4
Monisha A	Turned in Done late	Turned in Done late	Turned in	Turned in Done late	Turned in Done late	Turned in	5	4 Done late?

Stream	Classwork	People	Grades						
m	monisha krishnan	Missing	Turned in	Missing	Missing	Missing	Missing	Missing	Missing
	Nesa Kumar	Missing	Missing	Missing	Missing	Missing	Missing	4 Done late	5
N	Nikitha	Turned in Done late	Turned in	Turned in	Turned in	Turned in Done late	Turned in	5	5 Draft
	Paul Raj	Missing	Turned in Done late	Missing	Missing	Missing	Turned in	Missing	Missing
P	PURUSHOTHAMAN .R	Missing	Missing	Missing	Turned in	Turned in	Missing	3 Done late	4 Done late
	R Raghul	Missing	Missing	Missing	Turned in	Turned in	Missing	5	5
R	Raju Nani	Missing	Missing	Turned in	Turned in Done late	Turned in Done late	Turned in Done late	3 Done late	3 Done late
	Robin Son	Missing	Missing	Missing	Missing	Missing	Missing	3 Done late	4 Done late
R	Rohith Rohith	Missing	Missing	Missing	Missing	Missing	Missing	4 Done late	5
R	Rubesh Raj Kumar	Missing	Turned in	Turned in	Turned in	Turned in Done late	Turned in	5	5
S	Saru Vignesh	Turned in Done late	Missing	Missing	Turned in Done late	Turned in Done late	Missing	Missing	Missing
	SELF BELIEF VP	Turned in	Turned in	Turned in	Turned in	Turned in	Turned in	4 Done late	5
S	Shankar S	Turned in	Turned in	Turned in	Turned in	Turned in	Missing	5	5
	Shayam Ganesh	Missing	Turned in	Turned in Done late	Missing	Turned in Done late	Turned in	3 Done late	4
S	Shayini ramu	Turned in	Turned in	Turned in	Turned in	Turned in	Turned in	5	5
S	Shobana Sakthi	Turned in Done late	Turned in	Turned in	Turned in	Turned in	Missing	5	Missing
	subalakshmi Subalakshmi	Turned in	Turned in	Turned in	Turned in	Turned in Done late	Turned in	3 Done late	5 Draft
S	Surya Prakash	Missing	Missing	Missing	Missing	Missing	Missing	3 Done late	5 Draft
U	Usha Nandhini K	Turned in	Missing	Turned in	Turned in	Turned in Done late	Missing	5	Missing
V	vignesh s	Missing	Missing	Missing	Missing	Missing	Missing	3 Done late	4 Done late
X	Vijaya raj	Turned in	Turned in	Turned in	Turned in Done late	Turned in Done late	Turned in	5	5
	yegnesswar venkatesan	Turned in Done late	Turned in	Turned in	Turned in	Turned in Done late	Turned in	5 Done late	4 Done late
Y	Yogalakshmi Yogalakshmi	Turned in	Turned in	Turned in	Turned in	Turned in Done late	Missing	3 Done late	4 Done late
Y	Yogesh Yogesh	Missing	Missing	Missing	Missing	Missing	Missing	Missing	4 Done late

Teachers



P Preetha N

Students

50 students

Actions

A-Z

Aathi shakthi 27



A Abinaya Moorthi



Azar Ansari



Chareeshma Sk



Datchayani Gunaseelan



Deepak . T



Deepak ram.r



Deepika S



Dhana Lakshmi



Divya



G Ganesh Ganesh



H Hari Haran.V



Hari Priya .G



Hassan Farook



Iluckya K



I Indumathi



J Jananee Udaya



JITHESH _ SRINATH



J Jothishwaran Jothishwaran



Kamalesh Borana





























Kanmani Kanmani



Karpagam



Stream Classwork People Grades

-  Mohan 77 ⋮
-  N.deepika Nagarajan ⋮
-  Naveen Kumar Naveen ⋮
-  Nithyababu ⋮
-  Pandeewaran Pandi ⋮
-  Pooja S ⋮
-  Priya Dharshini ⋮
-  Punitha Gobi ⋮
-  RakeshRakesh S ⋮
-  Ranjani RR ⋮
-  rohith Kumar ⋮
-  Samuvel Kamal ⋮
-  Sandhya Devi ⋮
-  Sangeetha Sangeetha ⋮
-  shalini 13 ⋮
-  Shalini Sangee ⋮
-  Sneka T G ⋮
-  Solai raja Shanmugakani ⋮
-  sudharsan kumar ⋮
-  Swasanthosh3105 ⋮
-  Tamil Kalai ⋮
-  Tilip Kumar ⋮
-  Vaishnavi .k ⋮
-  Venkat Krish ⋮
-  Vinoth Kumar ⋮
-  Vnaveen Kumar ⋮
-  m dheepak ⋮

Create

All topics

Unit 4 revision test Due Nov 9, 2023, 1:30 PM

Stream Classes in Java 1 Due Sep 15, 2023, 11:30 AM

Java Question and Answer Posted Aug 11, 2023

Copy Constructor and Method Overloading Due Jul 31, 2023, 11:50 AM

Revision Test

Unit 3 revision Test Due Nov 15, 2023, 5:30 PM

Unit 3 revision Test Due Nov 10, 2023, 2:30 PM

Unit 5 Test 10 mark and 5 mark Due Nov 8, 2023, 12:05 PM

Control Structures

Control Structures Due Jul 17, 2023, 10:30 AM

Java Lab Manual

Java Lab Manual Posted Jul 13, 2023

JAVA NOTES

Java Exception Handling Posted Aug 26, 2023

Java Packages and API Posted Aug 23, 2023

Java Thread, Lifecycle, Multithreading, thre... Posted Aug 23, 2023

Java Arrays and string Posted Aug 17, 2023

Java 5 Units Notes Posted Jul 28, 2023

Java Notes Posted Jul 11, 2023

Customize

IIND YEAR JAVA



Announce something to your class



Preetha N posted a new assignment: Unit 3 revision Test
Nov 15, 2023



Preetha N posted a new assignment: Unit 3 revision Test
Nov 10, 2023 (Edited Nov 15, 2023)



Preetha N posted a new assignment: Unit 4 revision test
Nov 9, 2023



Preetha N posted a new assignment: Unit 5 Test 10 mark and 5 mark
Nov 7, 2023 (Edited Nov 7, 2023)



Ranjani RR
Sep 15, 2023



P.Ranjani



(stream class) java.pdf
PDF



Add class comment...



Deepak . T
Sep 15, 2023



T.Deepak



stream class.java.pdf
PDF



Add class comment...



Pandeeswaran Pandi
Sep 15, 2023



A.pandees waran



A. pandees waran (1).pdf
PDF

Stream Classwork People Grades

 Sandhya Devi
Sep 15, 2023
N.Sandhya devi

 DocScanner 14 Sept 2023 8-28 pm.pdf
PDF

 Add class comment...

 Kamalesh Borana
Sep 15, 2023
J.kamalesh Borana

 Stream class.pdf
PDF

 Add class comment...

 Deepak ram.r
Sep 14, 2023
Deepak Ram.R

 (stream class) Deepak Ram.R.pdf
PDF

 Add class comment...

Stream Classwork People Grades

Class average	N/A	N/A	N/A	N/A	4.63	4.79	4.48
Aathi shakthi 27	Turned in	Turned in Done late	Turned in Done late	Turned in Done late	4 Done late	4 Not turned in	5
Ablnaya Moorthi	Turned in Done late	Turned in Done late	Turned in Done late	Turned in Done late	Missing	Missing	4
Azar Ansari	Turned in	Missing	Missing	Missing	5	Missing	3 Done late
Chareeshma Sk	Turned in Done late	Turned in	Turned in	Missing	5	Missing	5
Datchayani Gunaseelan	Missing	Turned in	Turned in	Turned in	5	Missing	Missing
Deepak . T	Missing	Turned in	Turned in	Turned in	5 Resubmitted	5/5 Done late	Missing
Deepak ram.r	Turned in	Turned in	Turned in	Turned in Done late	5	5/5 Done late	Missing
Deepika S	Turned in	Turned in	Turned in	Turned in	5	5/5 Done late	Missing
Dhana Lakshmi	Turned in	Turned in	Turned in	Turned in	4 Done late	Missing	5
Divya	Turned in Done late	Turned in	Turned in	Turned in	5	5	Missing
Ganesh Ganesh	Missing	Turned in Done late	Turned in Done late	Turned in Done late	Missing	4 Done late	Missing
Hari Haran.V	Turned in	Turned in	Turned in	Turned in	5	5	5
Hari Priya .G	Turned in	Turned in	Turned in Done late	Turned in	4 Done late	Missing	Missing
Hassan Farook	Turned in Done late	Turned in	Turned in	Turned in	5	5 Resubmitted	Missing
Iluckya K	Turned in Done late	Turned in Done late	Turned in	Turned in Done late	5/5 Draft	Missing	Missing
Indumathi	Turned in	Turned in	Turned in	Turned in Done late	5	Missing	Missing
Jananee Udaya	Turned in	Turned in	Turned in	Turned in	5	5	5
JITHESH _SRINATH	Missing	Turned in	Turned in	Turned in	5	5/5 Done late	5
Jothishwaran Jothishwaran	Missing	Missing	Missing	Missing	Missing	Missing	Missing
Kamalesh Borana	Missing	Turned in	Turned in	Turned in Done late	5 Draft	Missing	4 Done late
Kanmani Kanmani	Turned in	Turned in	Turned in	Turned in	5 Draft	Missing	Missing
Karpagam	Turned in Done late	Missing	Turned in Done late	Turned in Done late	5	Missing	Missing
Manoj Kumar. J	Missing	Missing	Missing	Missing	5	Missing	Missing
Mohan 77	Missing	Turned in	Turned in	Missing	Missing	Missing	Missing

Stream: Classwork People Grades

Stream	Classwork	People	Grades	Grades	Grades	Grades	Grades	Grades
N	N.deepika Nagarajan	Turned in	Turned in	Missing	Turned in Done late	5	.../5 Done late	Missing
N	Naveen Kumar Naveen	Missing	Missing	Missing	Missing	4 Done late	4 Done late	3 Done late
N	Nithyababu	Turned in	Turned in	Turned in	Turned in	5	5	5
P	Pandeewaran Pandi	Turned in	Turned in	Turned in	Turned in	3 Draft	Missing	Missing
P	Pooja S	Turned in	Turned in	Missing	Turned in	4 Done late	Missing	5
P	Priya Dharshini	Turned in	Turned in	Turned in	Turned in	4 Done late	.../5 Done late	5
P	Punitha Gobi	Turned in	Turned in	Turned in	Turned in	5	Missing	Missing
R	RakeshRakesh S	Missing	Missing	Missing	Missing	3 Done late	Missing	5
R	Ranjani RR	Missing	Turned in	Missing	Turned in Done late	4 Done late	Missing	Missing
R	rohith Kumar	Turned in	Turned in	Turned in	Turned in Done late	5	5	4
R	Samuvel Kamal	Turned in	Turned in Done late	Turned in	Turned in	4 Done late	Missing	Missing
S	Sandhya Devi	Turned in	Turned in	Turned in	Turned in Done late	5	.../5 Done late	Missing
S	Sangeetha Sangeetha	Turned in	Turned in	Turned in	Turned in Done late	5	Missing	Missing
S	shalini 13	Turned in	Turned in	Turned in	Turned in Done late	5	5	4
S	Shalini Sangee	Turned in	Turned in	Turned in	Turned in	4 Done late	.../5 Done late	Missing
S	Sneha G	Turned in Done late	Turned in Done late	Turned in Done late	Turned in	5	Missing	5
S	Solai raja Shanmugakani	Turned in	Turned in	Turned in	Turned in	5	5	5
S	sudharsan kumar	Missing	Missing	Missing	Missing	5	Missing	4
S	Swasanthosh3105	Turned in	Turned in	Missing	Missing	4 Not turned in	Missing	5
S	Tamil Kalai	Missing	Missing	Missing	Missing	Missing	Missing	Missing
S	Tilip Kumar	Missing	Turned in Done late	Turned in	Turned in Done late	Missing	Missing	Missing
S	Vaishnavi .k	Turned in	Turned in	Turned in	Turned in	5	5	3 Done late
V	Venkat Krish	Missing	Missing	Missing	Missing	Missing	Missing	Missing
V	Vinoth Kumar	Missing	Turned in Done late	Turned in	Missing	5	Missing	4
V	Vnaveen Kumar	Missing	Missing	Missing	Missing	4 Done late	5	Missing
V	m dheepak	Turned in	Turned in	Turned in	Turned in	5	5	5



G. Srinivasan
 PRINCIPAL,
 DHARMAMURTHI RAO BAHADUR CHAVALA CUNNAM
 CHETTY'S HINDU COLLEGE
 DHARMAMURTHI RAO BAHADUR CHAVALA
 CHENNAI - 600 012.

4. b) Equipments

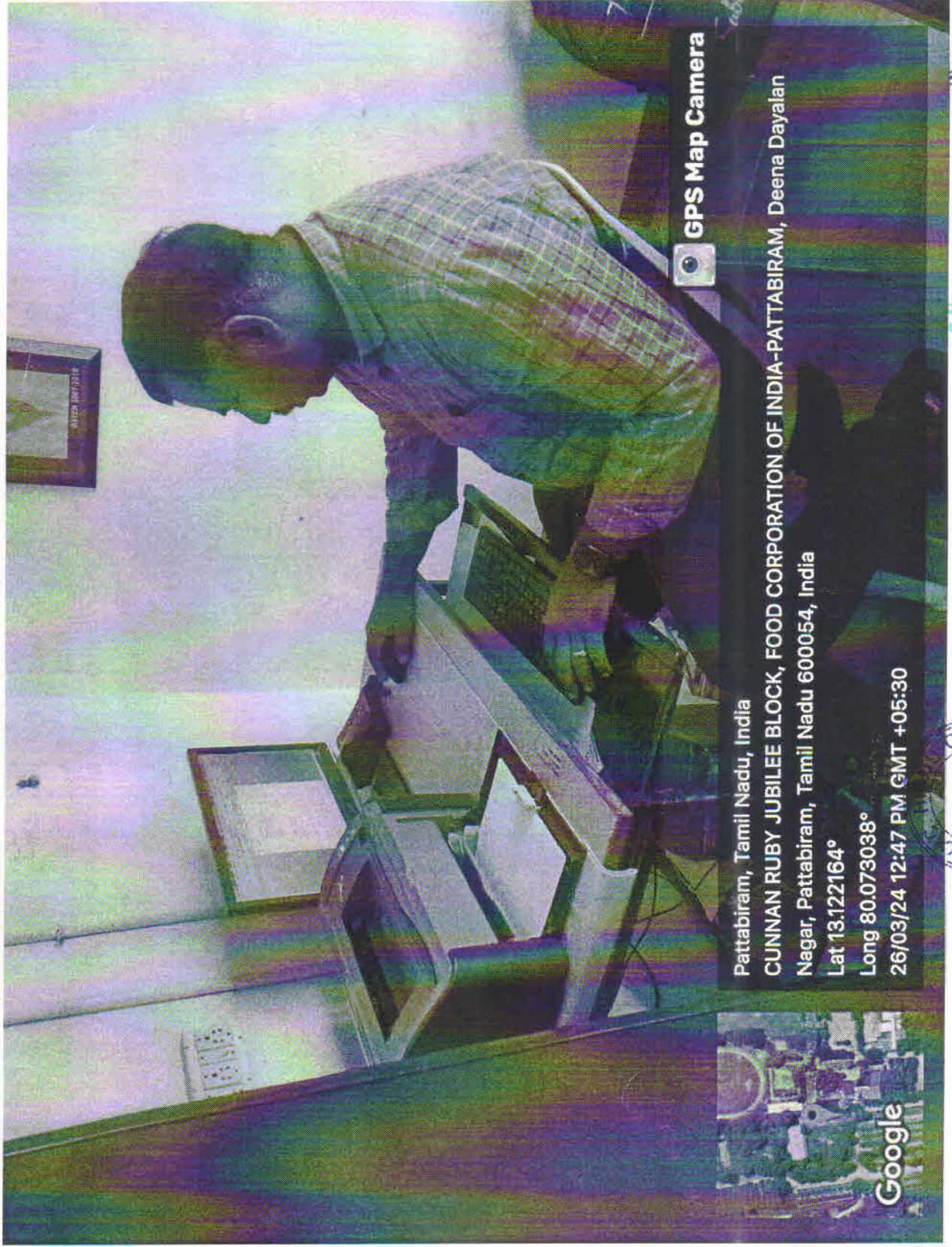

GPS Map Camera

Pattabiram, Tamil Nadu, India
CUNNAN RUBY JUBILEE BLOCK, FOOD CORPORATION OF INDIA-PATTABIRAM, Deena Dayalan
Nagar, Pattabiram, Tamil Nadu 600054, India
Lat 13.122164°
Long 80.073038°
26/03/24 12:47 PM GMT +05:30

Google

Dr. J. S. Murthy

C. Kalinivasan
PRINCIPAL,
REGALAVALA CUNNAN
COLLEGE
DHARMAMURTHI PAC
CHETTY
PATTABIRAM
TAMIL NADU - 600054





Pattabiram, Tamil Nadu, India

43CF+PXQ, Modern City, Deena Dayalan Nagar, Pattabiram, Tamil Nadu
600054, India
Lat 13.121699°
Long 80.075292°
27/07/23 03:02 PM GMT +05:30

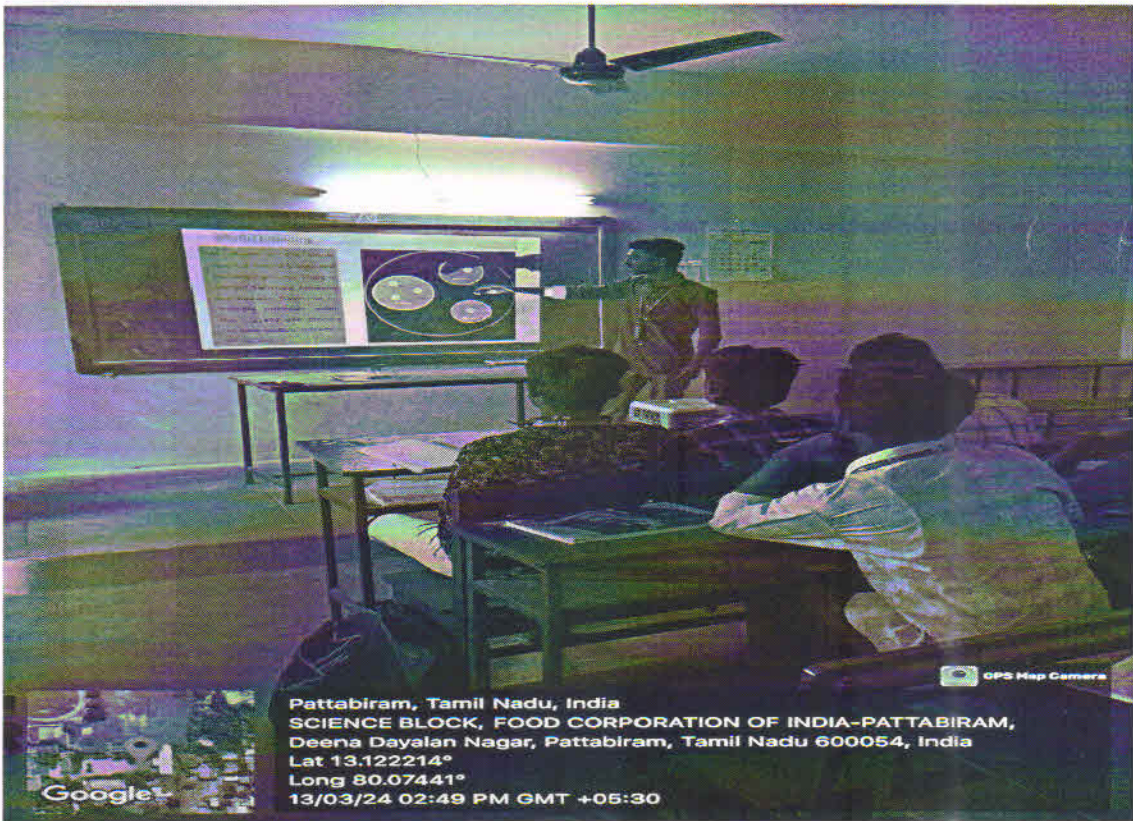

Pattabiram, Tamil Nadu, India
SCIENCE BLOCK, FOOD CORPORATION OF INDIA-PATTABIRAM,
Deena Dayalan Nagar, Pattabiram, Tamil Nadu 600054, India
Lat 13.122214°
Long 80.07441°
13/03/24 02:49 PM GMT +05:30

Dra. Sriswathi
Dharmamurthi Rao Bahadur
Jalavala Cunnan Chetty's Hindu College (Shift :
Dharmamurthi Nagar,
Pattabiram, Chennai-600072.

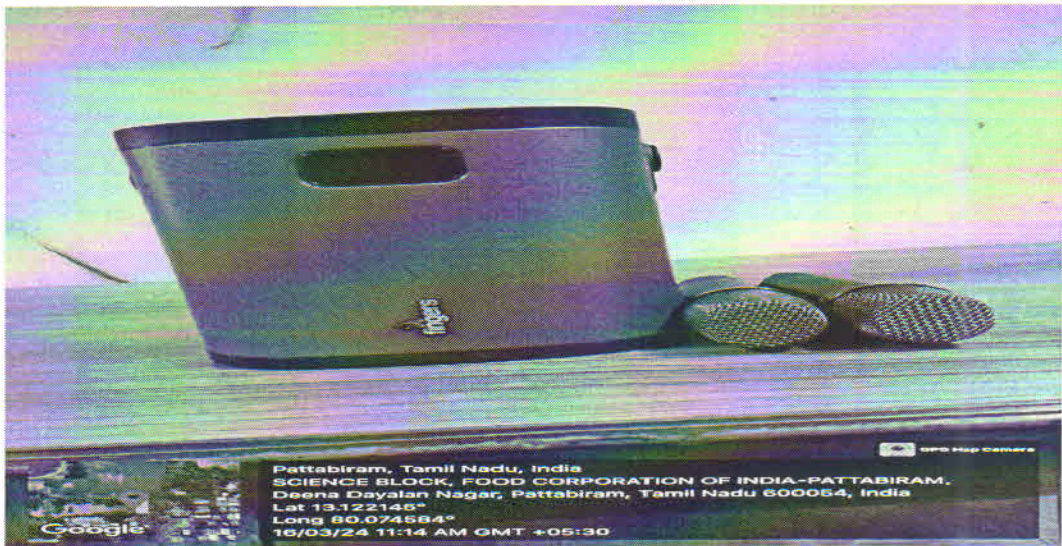
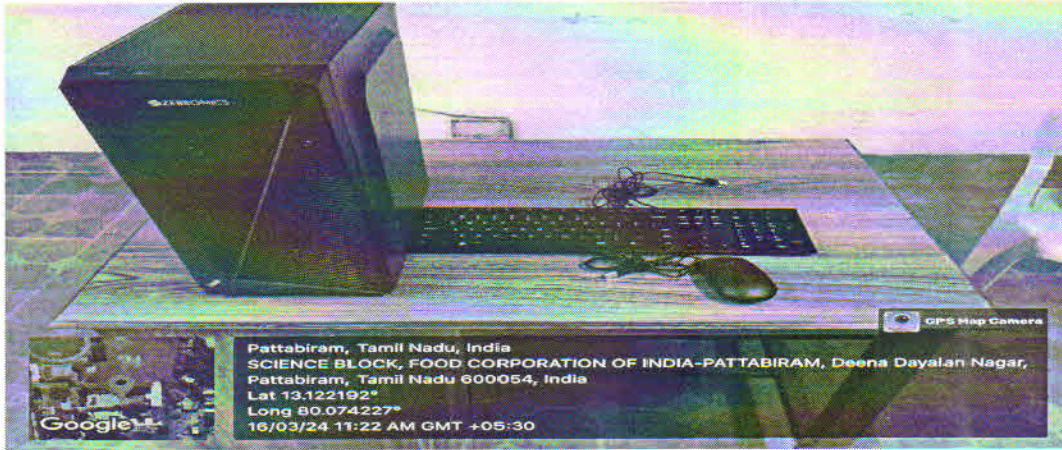

Dr. U. Sri Senthil
Dharmamurthi Rao Bahaour
Calavala Cunnan Chetty's Hindu College (Shri...
Dharmamurthi Nagar,
Pattabiram, Chennai-600072.

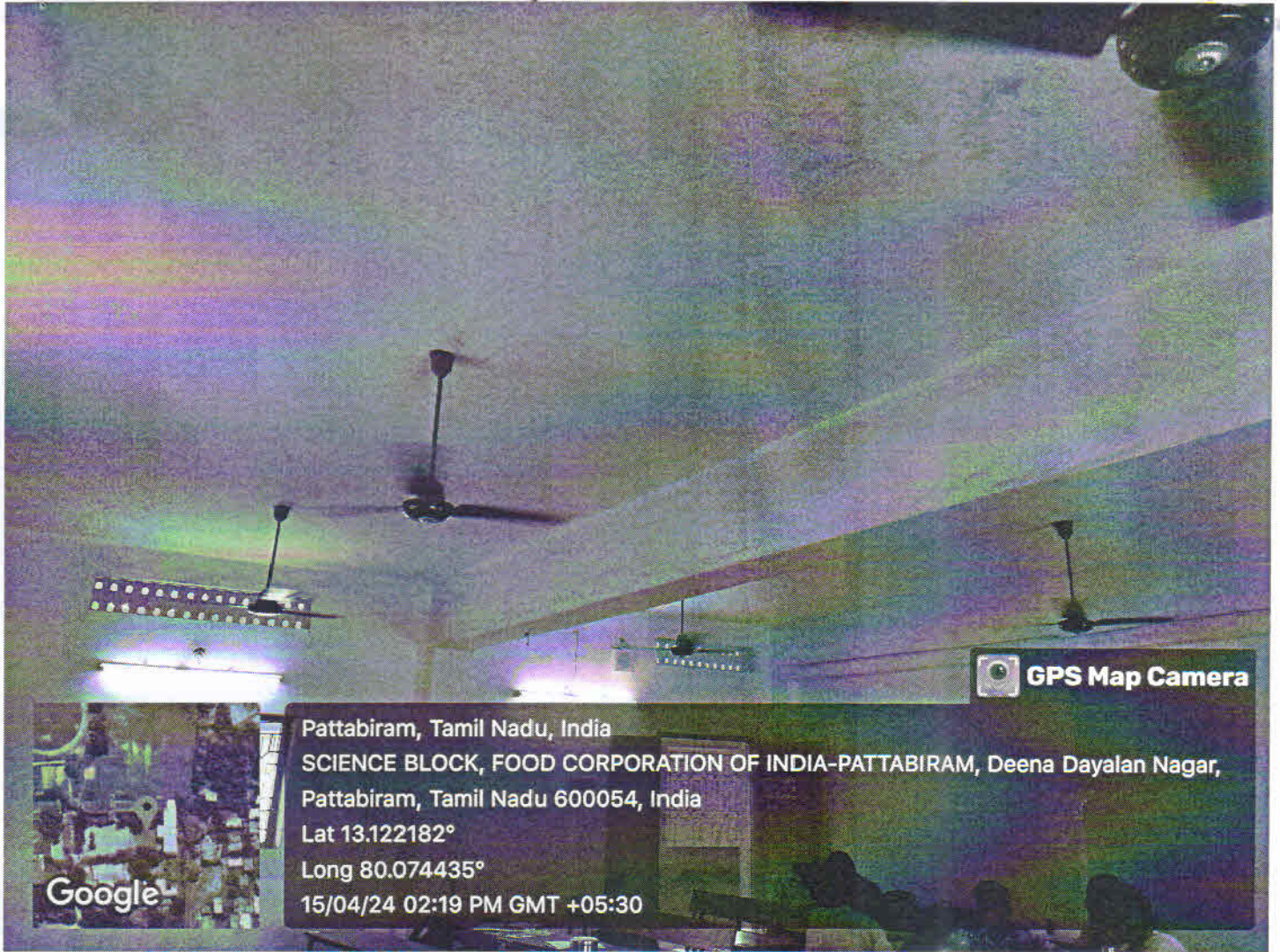

 **GPS Map Camera**

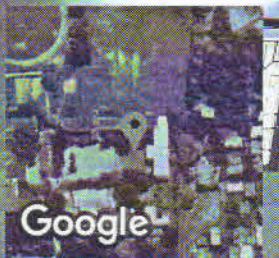

Pattabiram, Tamil Nadu, India
 SCIENCE BLOCK, FOOD CORPORATION OF INDIA-PATTABIRAM, Deena Dayalan Nagar,
 Pattabiram, Tamil Nadu 600054, India
 Lat 13.122182°
 Long 80.074435°
 15/04/24 02:19 PM GMT +05:30

Dr. U. Sai Smith

Dharmamurthi Rao Bahadur
 Calavala Chettiar Chetty's Hindu College (Shri)
 Dharmamurthi Nagar,
 Pattabiram, Chennai-600072



G. Lakshminaray

PRINCIPAL,
 DHARMAMURTHI RAO BAHADUR CALAVALA CUNNAM
 CHETTY'S HINDU COLLEGE
 DHARMAMURTHI NAGAR, PATTABIRAM,
 CHENNAI - 600 072.

2.3.2

ICT enabled Classes

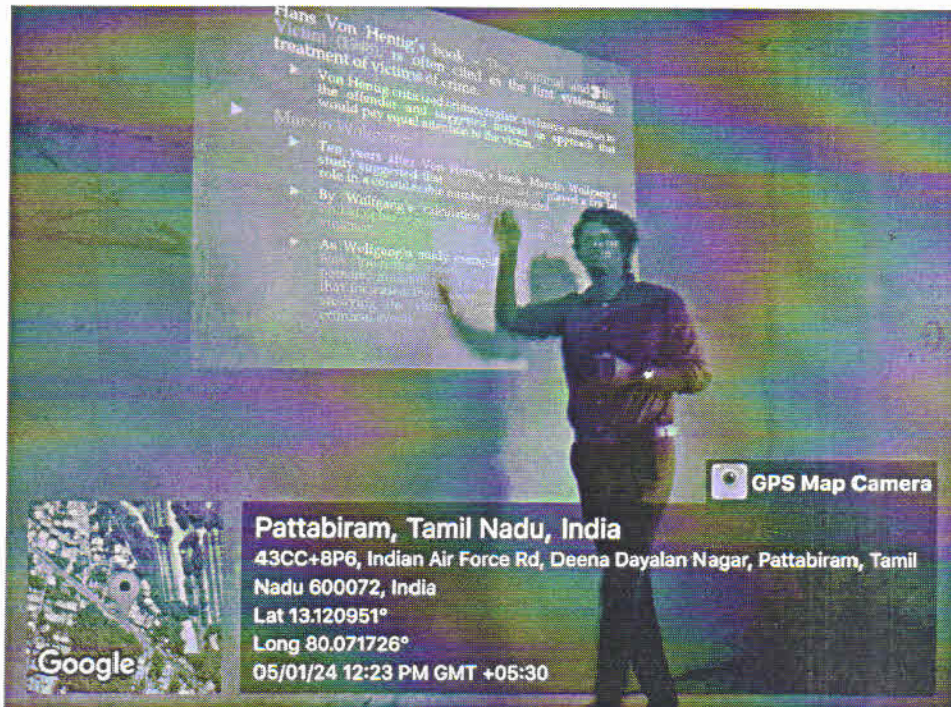
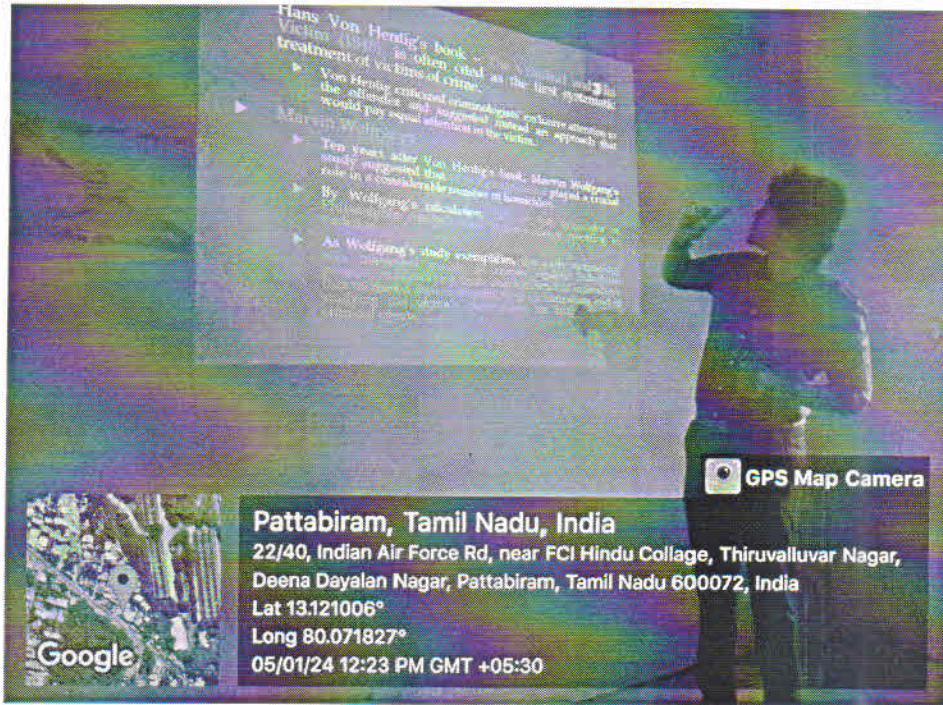

G. Narayanasamy
 PRINCIPAL,
 DHARMAMURTHI RAO BAHADUR GALAVALA GUNNAM
 CHETTY HINDU COLLEGE
 PATTABIRAM, CHENNAI - 72

Ed. Jambhale
 DEPARTMENT OF CRIMINOLOGY
 AND POLICE ADMINISTRATION
 DRBCCC HINDU COLLEGE
 PATTABIRAM, CHENNAI - 72.

C. K. Jay
Pharmacist
Chennai-600008

GPS Map Camera

19/03/24 01:34 PM

Action	Student Name	Unit Number	Registration Number	Mobile Number	Gen
17	CHANDRA	PH0020214	100000000	988888888	MA
17	CHANDRA	PH0020214	100000000	988888888	MA
17	CHANDRA	PH0020214	100000000	988888888	MA
17	CHANDRA	PH0020214	100000000	988888888	MA
17	CHANDRA	PH0020214	100000000	988888888	MA



Dharm
Kathavala
Patil
K. S. Bahadur
Hindu College (Shift 2)
Shri Nagar,
Mumbai-500072

Prof. C

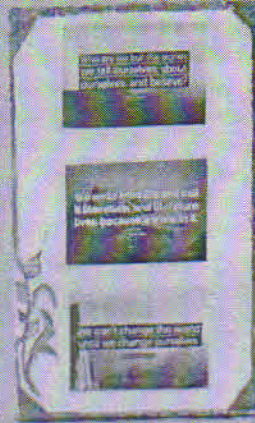

SEMESTER

SEMESTER

CONTEMPORARY LITERATURE

POST COLONIAL LITERATURE IN ENGLISH

INDIAN LITERATURE IN ENGLISH

GREEN STUDIES

WOMEN'S WRITING

EXTENSION ACTIVITIES

DATE	TIME	THUR	FRI
32	58	52	

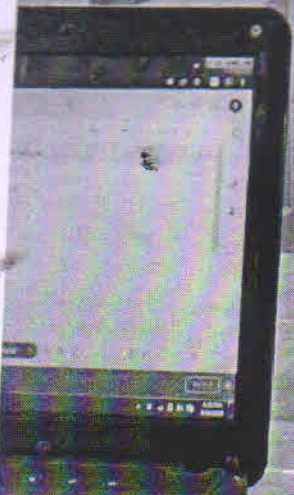
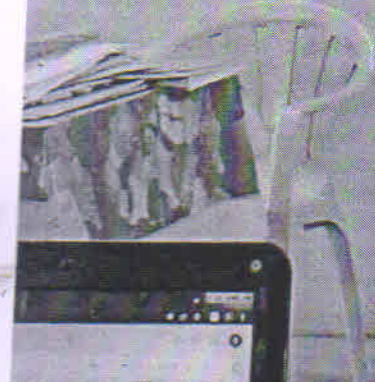
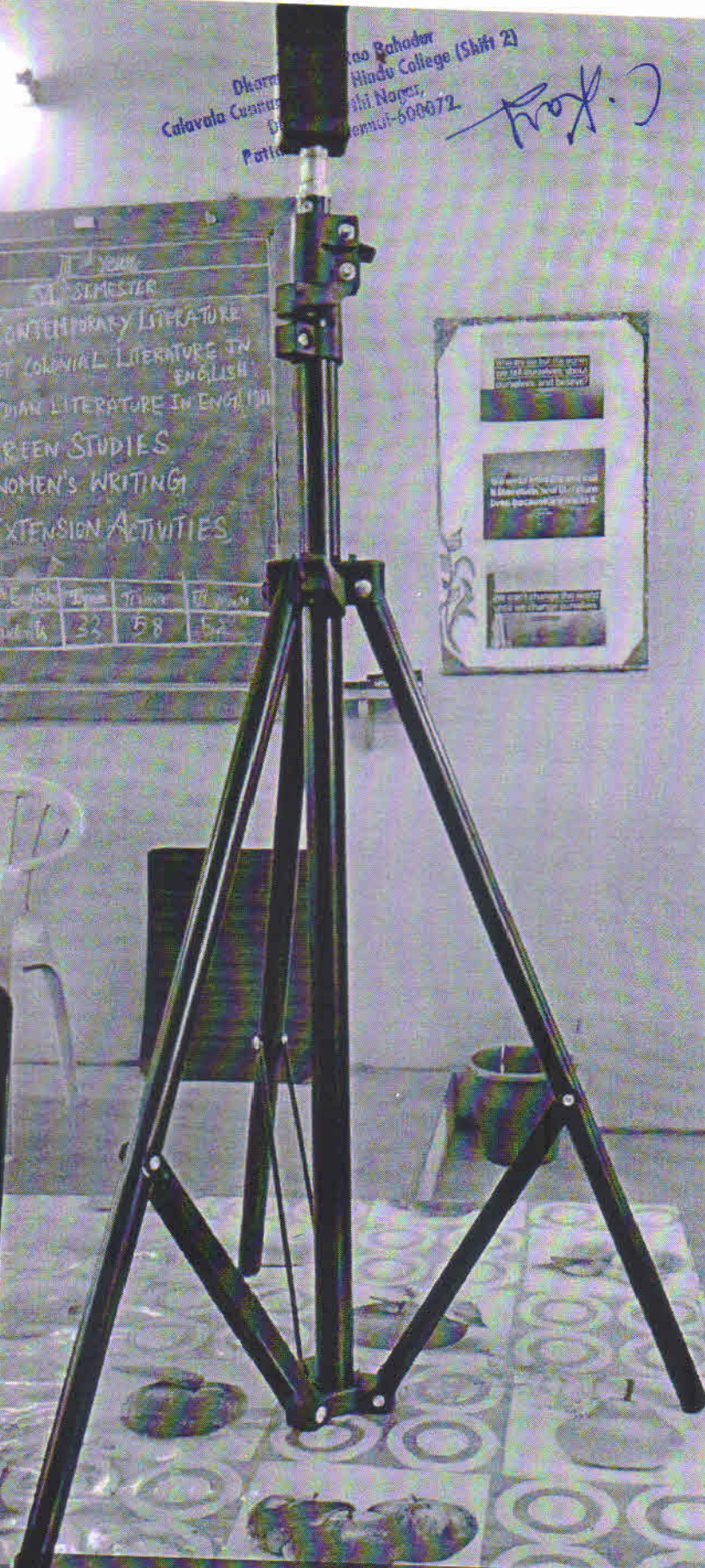

19/03/24 01:28 PM

GPS Map Camera

Google

Equipments

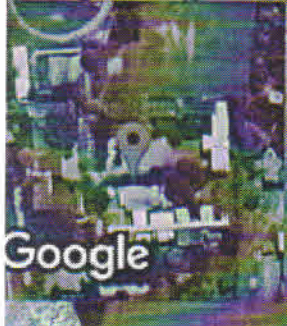

Pattabiram, Tamil Nadu, India
SCIENCE BLOCK, FOOD CORPORATION OF INDIA-PATTABIRAM, Deena Dayalan
Nagar, Pattabiram, Tamil Nadu 600054, India
Lat 13.121958°
Long 80.073989°
14/03/24 12:53 PM GMT +05:30



[Handwritten signature]



Pattabiram, Tamil Nadu, India
 SCIENCE BLOCK, FOOD CORPORATION OF INDIA-PATTABIRAM, Deena Dayalan Nagar, Pattabiram,
 Tamil Nadu 600054, India
 Lat 13.121984°
 Long 80.074005°
 14/03/24 12:55 PM GMT +05:30

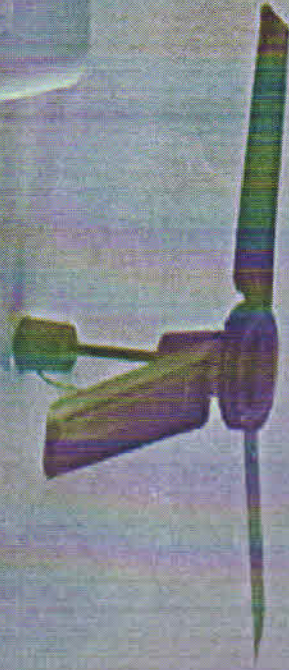
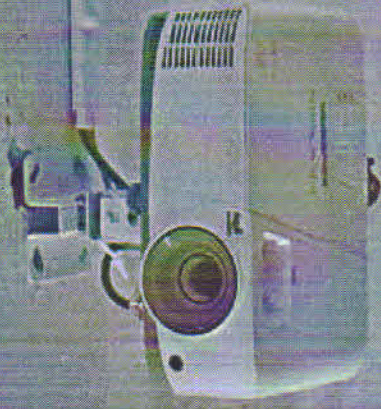

 **GPS Map Camera**

Pattabiram, Tamil Nadu, India

SCIENCE BLOCK, FOOD CORPORATION OF INDIA-PATTABIRAM, Deena Dayalan Nagar, Pattabiram,

Tamil Nadu 600054, India

Lat 13.122018°

Long 80.073917°

14/03/24 12:54 PM GMT +05:30



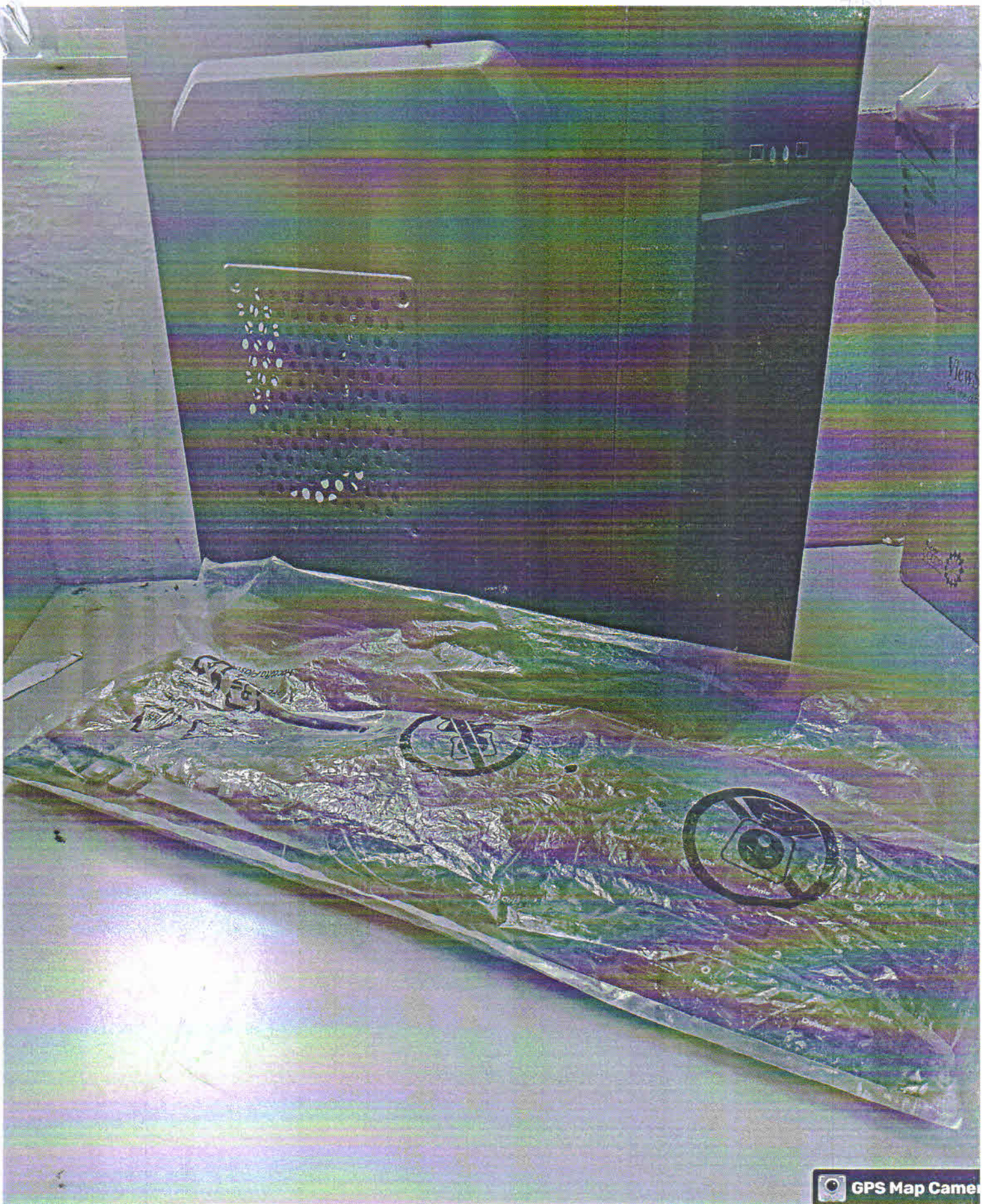

GPS Map Camera



Pattabiram, Tamil Nadu, India
130, 10th St, Modern City, Deena Dayalan Nagar, Pattabiram, Tamil Nadu 600072, India
Lat 13.1234°
Long 80.07684°
18/03/24 01:31 PM GMT +05:30

100 tools

PEER TUTORING



GPS Map Camera

Google

Pattabiram, Tamil Nadu, India
SCIENCE BLOCK, FOOD CORPORATION OF INDIA-PATTABIRAM, Deena Dayalan
Nagar, Pattabiram, Tamil Nadu 600054, India
Lat 13.122308°
Long 80.074074°
27/10/23 01:14 PM GMT +05:30



GPS Map Camera

Google

Pattabiram, Tamil Nadu, India
SCIENCE BLOCK, FOOD CORPORATION OF INDIA-PATTABIRAM, Deena Dayalan
Nagar, Pattabiram, Tamil Nadu 600054, India
Lat 13.122308°
Long 80.074074°
27/10/23 01:14 PM GMT +05:30

[Handwritten signature]

[Handwritten signature]
Prof. Indhra M Mandey MBA..M.Phil.. M Com..
NET(MGT) Head -
Department of Business Administration (Shift 2)
Dharmamurthi Rao Bahadur Calavala Cunnan
Chetty's Hindu College.
Pattabiram, Chennai-600 072.

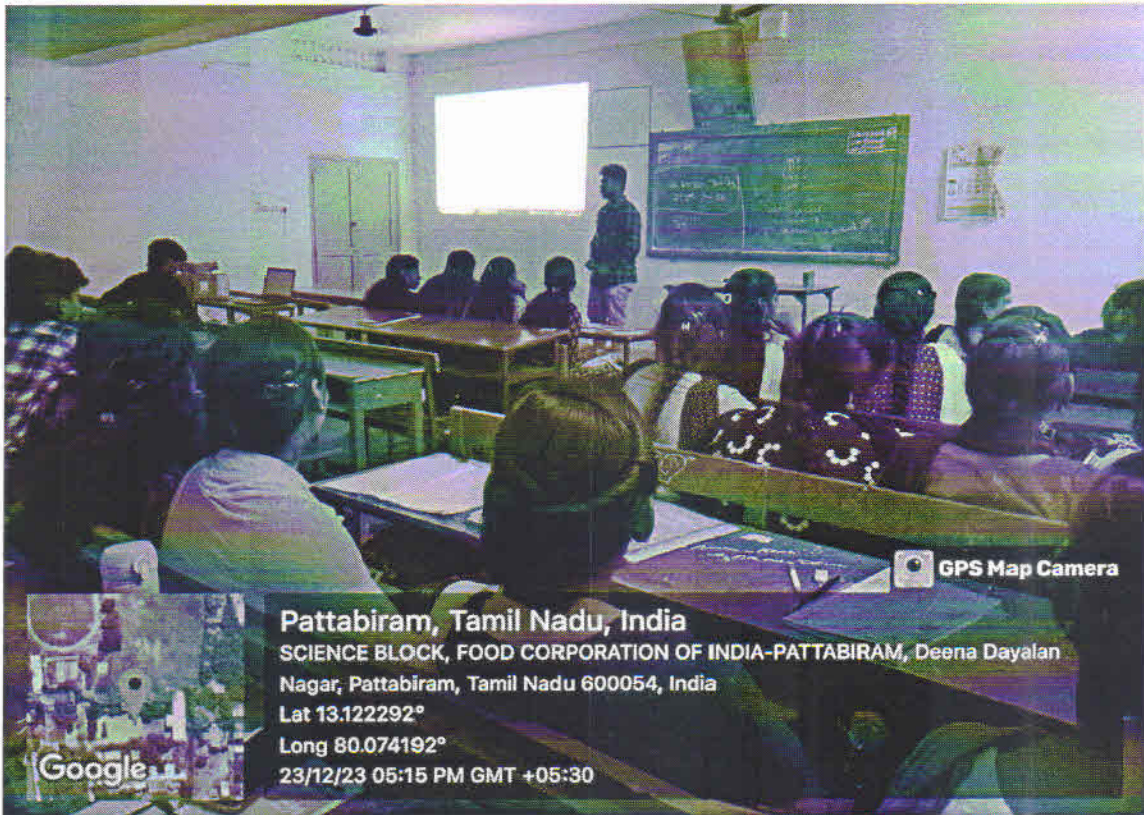

Indra

Indra

Prof. Indhra M Mandey MBA, M.Phil., M.Com.,
NET(MGT) Head -
Department of Business Administration (Shift 2)
Dharmamurthi Rao Bahadur Calavala Cunnan
Chetty's Hindu College,
Pattabiram, Chennai - 600 054

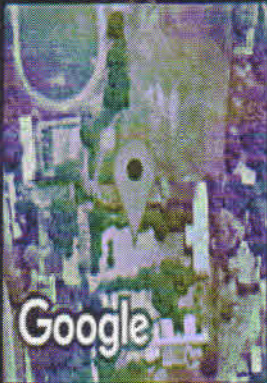
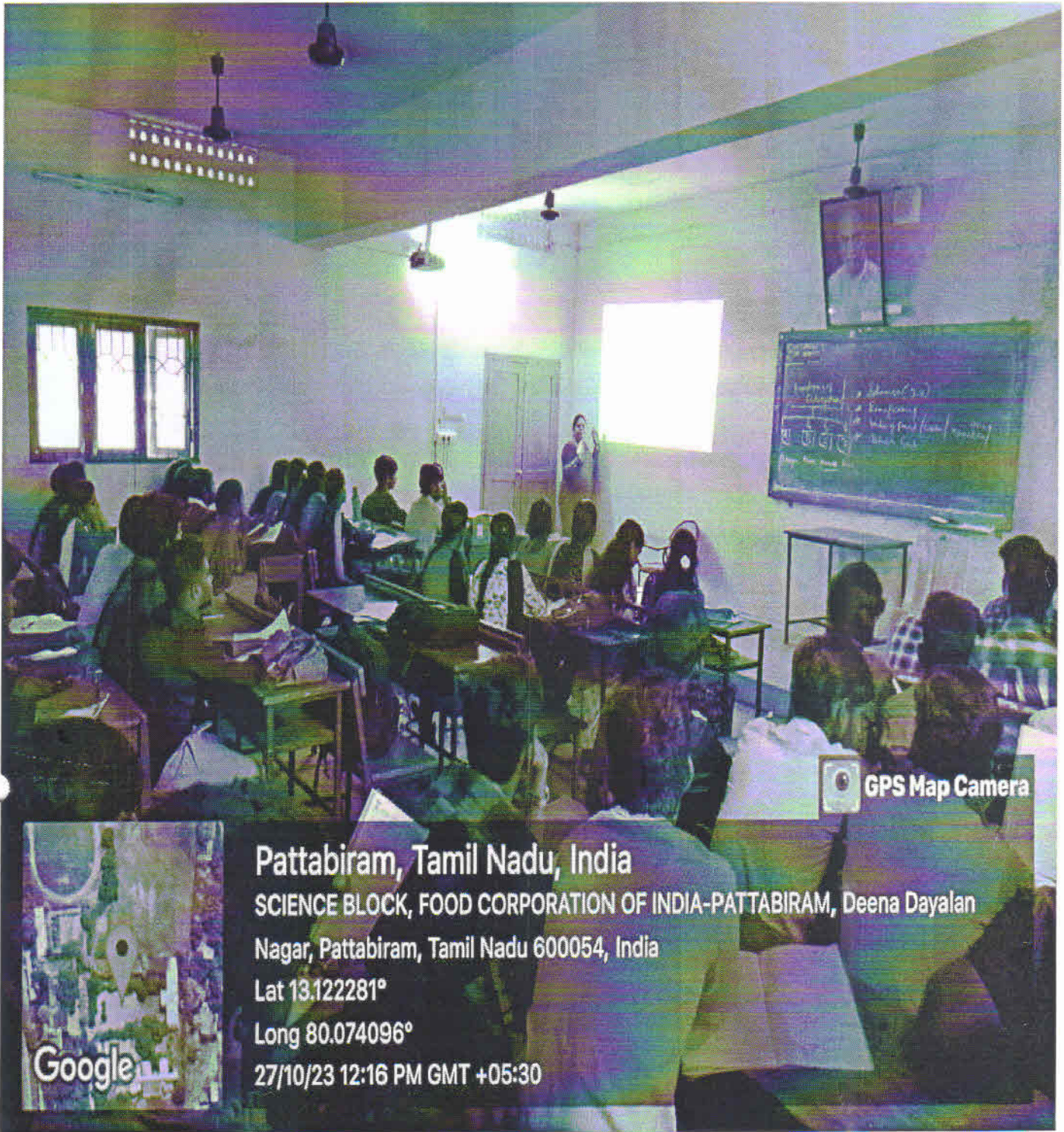

Pattabiram, Tamil Nadu, India

SCIENCE BLOCK, FOOD CORPORATION OF INDIA-PATTABIRAM, Deena Dayalan

Nagar, Pattabiram, Tamil Nadu 600054, India

Lat 13.122281°

Long 80.074096°

27/10/23 12:16 PM GMT +05:30

GPS Map Camera

Indra

Indra

Prof.Indhra M Mandey MBA..M.Phil., M.Com.,

NET(MGT) Head -

Department of Business Administration (Shift 2)

Dharmamurthi Rao Bahadur Calavala Cunnan

Chetty's Hindu College.

Pattabiram, Chennai - 600 072.

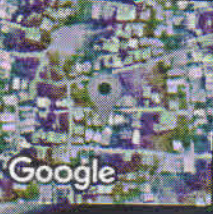

Avadi, Tamil Nadu, India
 438F+F26, Avadi, Pattabiram, Tamil Nadu 600072, India
 Lat 13.116405°
 Long 80.072525°
 27/10/23 01:28 PM GMT +05:30



Pattabiram, Tamil Nadu, India
 SCIENCE BLOCK, FOOD CORPORATION OF INDIA-PATTABIRAM, Deena Dayalan
 Nagar, Pattabiram, Tamil Nadu 600054, India
 Lat 13.12229°
 Long 80.074081°
 01/08/23 04:51 PM GMT +05:30

[Handwritten signature]

[Handwritten signature]
 NET(MGT) Head -
 Department of Business Administration (Shift 2)
 Dharmamurthi Rao Bahadur Calavala Cunnah
 Chetty's Hindu College,
 Pattabiram, Chennai - 600 072.

Class settings

Save

About

Title
BBA DRBCCC 2225 MKT MGT

Description

Section
A

Room
3

Subject
Marketing Management

General

Student invitation settings

Class code: tmpptri

Invitation link:
<https://classroom.google.com/c/NjE...>

Manage Meet link

17:27

45%



Indhra Mandey
20 Oct 2023

Part B Past year Univ Q.Papers

Attachments



Materials
Management Par...

Save all files offline

Class comment

Prof. Indhra M Mandey MBA..M.Phil.. M Com..
NET(MGT) Head -
Department of Business Administration (Shift 2)
Dharmamurthi Rao Bahadur Calavala Cunnar
Chetty's Hindu College.
Pattabiram, Chennai - 600 072.

MarketingManagement

<https://classroom.google.com/c/NjU0NTE4Njg5OTE3?cjc=vx5ofqg>

Recommended Texts

1. Philip Kotler, 2003, Marketing Management, 11th edition, Pearson Education (Singapore) Pte Ltd, NewDelhi.
2. V.S. Ramaswamy&S.Namakumari, 1994, Principles of Marketing, first edition, S.G.Wasani / Macmillan India Ltd, NewDelhi.
3. Crrainfield, Marketing Management, PalgraveMacmillan
4. Sontakki . C.N , Marketing Management, KalyanniPublishers,Ludhiana
5. Gary Armstrong & Philip Kotler, 2003, Marketing -An Introduction, sixth edition, Pearson Education (Singapore) Pvt Ltd, NewDelhi.
6. R.S.N. Pillai and Bagavathi ,Modern Marketing , S.Chand& Co , NewDelhi.
7. Jayasankar, Marketing, Marghampublications,Chennai.



Prof.Indhra M Mandeey MBA..M.Phil.. M.Com.,
NET(MGT) Head -
Department of Business Administration (Shift 2)
Dharmamurthi Rao Bahadur Calavala Cunnan
Chetty's Hindu College.
Pattabiram, Chennai - 600 072.

× Class settings

Save

About

Title
BBA DRBCCC 2225 MKT MGT

Description

Section
A

Room
3

Subject
Marketing Management

General

Student invitation settings

Class code: tmpptri

Invitation link:
<https://classroom.google.com/c/NjE...>

Manage Meet link



Indhra Mandey

14 Jul 2023

Module 2 blended learning material

Attachments



Consumer Buyer Behaviour

Class comment



Prof. Indhra M Mandey MBA, M.Phil., M.Com.,
NET(MGT) Head -
Department of Business Administration (Shift 2),
Pharmamurthi Rao Bahadur Calavala Cunnan
Chetty's Hindu College,
Pattabiram, Chennai - 600 022.

Material Management

<https://classroom.google.com/c/NjE1MTk0ODc2MTcy?cjc=no577vm>

REFERENCE BOOKS:

1. P.Saravanel and S.sumathi, Production and Materials Management, Margham publications, 2015
2. M.M Verma, Materials Management, Sultan Chand Publications,2012.
3. Hill, Operations managent,PalgraveMacmillan.



Prof.Indhra M Mandey MBA.,M.Phil., M Com.,
NET(MGT) Head -
Department of Business Administration (Shift 2)
Dharmamurthi Rao Bahadur Calavala Cunnan
Chetty's Hindu College.
Pattabiram, Chennai - 600 072.

Class settings

Save



About

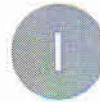

Indhra Mandey

20 Oct 2023

Part B Past year Univ Q.Papers

Title
BBA DRBCCC 2124 MAT

Description

Section
A

Room
1

Subject
Materials Management

Attachments

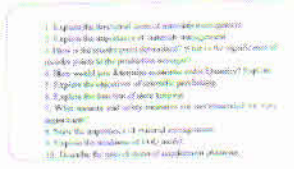

Materials Management Par...

Save all files offline

General

Student invitation settings

Class code: no577vm

Invitation link:
<https://classroom.google.com/c/NjE...>

Manage Meet link



PRINCIPAL,
DHARMAMURTHI RAO BHADUR CALAVALA CUNNAN
CHETTY'S HINDU COLLEGE
DHARMAMURTHI NAGAR, PATTABIRAM,
CHENNAI - 600 076.

Class comment

Prof.Indhra M Mandey MBA..M.Phil.. M Com.,
NET(MGT) Head -
Department of Business Administration (Shift 2)
Dharmamurthi Rao Bahadur Calavala Cunnan
Chetty's Hindu College

Entrepreneurial Development

<https://classroom.google.com/c/NjE1MTk0ODQ3MDQ5?cjc=4lr2cbx>

REFERENCE BOOKS:

1. Barringer, B., Entrepreneurship: Successfully Launching New Ventures, 3rd Edition, Pearson, 2011.
2. Bessant, J., and Tidd, J., Innovation and Entrepreneurship, 2nd Edition, John Wiley & Sons, 2011.
3. Desai, V., Small Scale Industries and Entrepreneurship, Himalaya Publishing House, 2011.
4. Donald, F.K., Entrepreneurship- Theory, Process and Practice, 9th Edition, Cengage Learning, 2014.
5. Hirsch, R.D., Peters, M. and Shepherd, D., Entrepreneurship, 6th Edition, Tata McGraw-Hill Education Pvt.Ltd., 2006.
6. Mathew, J.M., Entrepreneurship Theory at Cross Roads: Paradigms and Praxis, 2nd Edition, Dream Tech, 2006.
7. Morse, E., and Mitchell, R., Cases in Entrepreneurship: The Venture Creation Process, Sage South Asia, 2008.
8. Nagendra and Manjunath, V.S., Entrepreneurship and Management, Pearson, 2010.
9. Reddy, N., Entrepreneurship: Text and Cases, Cengage Learning, 2010.
10. Roy, R., Entrepreneurship, 2nd Edition, Oxford University Press, 2011.
11. Stokes, D., and Wilson, N., Small Business Management and entrepreneurship, 6th Edition, Cengage Learning, 2010.



Prof. Indhira M Mandey MBA, M.Phil., M.Com.,
NET(MGT) Head -
Department of Business Administration (Shift 2)
Dharmamurthi Rao Bahadur Calavala Cunnan
Chetty's Hindu College,
Pattabiram, Chennai - 600 072.

Class settings

Save



About

Title

BBA DRBCCC ED 2124

Description

Section

A

Room

2

Subject

Entrepreneurial Development

General

Student invitation settings



Class code: 4lr2cbx

Invitation link:

<https://classroom.google.com/c/NjE...>



Manage Meet link



Indhra Mandey

20 Oct 2023

Past year univ part c q.papers

Attachments

1. Distinguish between entrepreneur and professional manager.
2. Briefly explain the role of entrepreneurial development agencies in the promotion of industries.
3. Describe the contents of project feasibility study report.
4. Examine the role of entrepreneur in economic development.



ED Part C Past year Univ q papers.pdf

Save all files offline

Class comment

Prof. Indhra M Mandey MBA, M.Phil., M.Com.,
NET(MGT) Head -

Department of Business Administration (Shift 2)

Dharmamurthi Rao Bahadur Calavala Cunnan

Chetty's Hindu College,

Padubiram, Chennai - 600 072



DHARMAMURTHI RAO BAHADUR CALAVALA CUNNAN CHETTY'S HINDU COLLEGE

DEPARTMENT OF BUSINESS ADMINISTRATION (SHIFT-II)

REPORT ON PEER TUTORING

II BBA

DATE: 18:01:2024

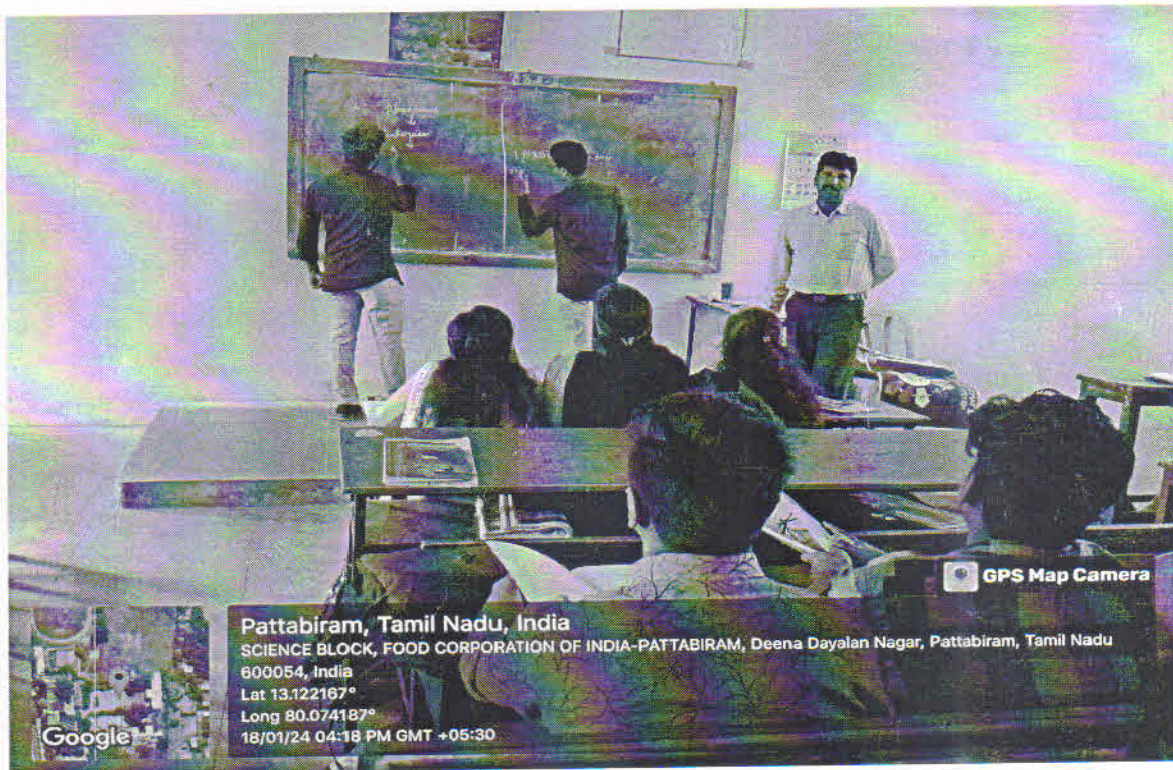

Prof. Indhra M. Mandey MBA M.Phil. M.Com.,
NET(MGT) Head
Department of Business Administration (Shift 2)
Dharmamurthi Rao Bahadur Calavala Cunnan
Chetty's Hindu College
Pattabiram, Chennai - 600 072.

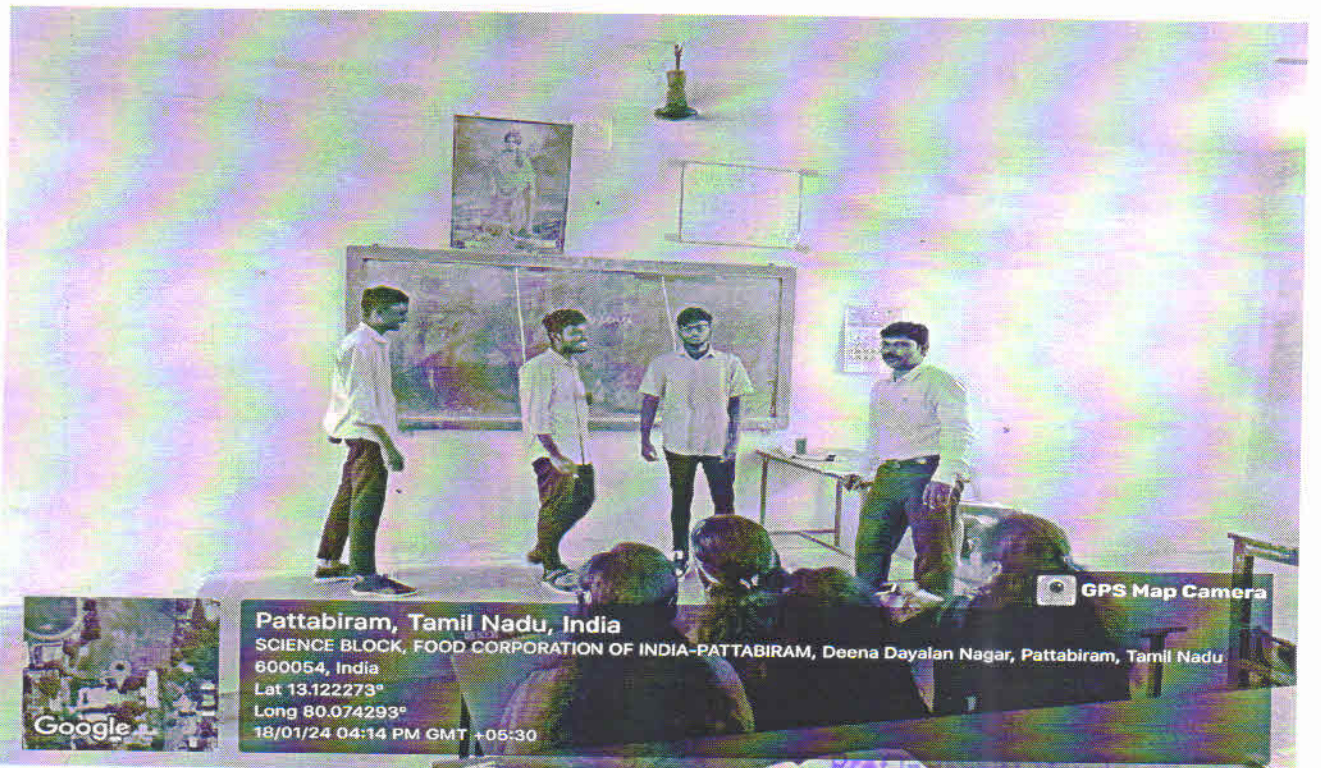

- 1 H. Mohit - Mohit-H
 - 2 R. MURUGESH - R. MUKESH
 - 3 S. Gowtham - S. Gowtham
 - 4 V. BHAVANESWARAN - V. BHAVANESWARAN
 - 5 D. KUNJA - D. THOMAS
 - 6 SATHYA KUMAR - SATHYA KUMAR
 - 7 P. PAWITRA - PAWITRA . P
 - 8 K. KANAKA - KANAKA .
- Peer Tutor

Polakalyan
 Dr. B. KALAIYARASAN
 Subject Handling

NETING
 Department of Business Administration
 Dharmamurthy Rao Bahadur Chetty's Hindu College
 Pattabiram, Chennai - 600054

[Signature]
 HOD



DHARMAMURTHI RAO BAHADUR CALAVALA CUNNAN CHETTY'S HINDU COLLEGE

DEPARTMENT OF BUSINESS ADMINISTRATION (SHIFT-II)

REPORT ON PEER TUTORING

III BBA

DATE: 18/01/2024

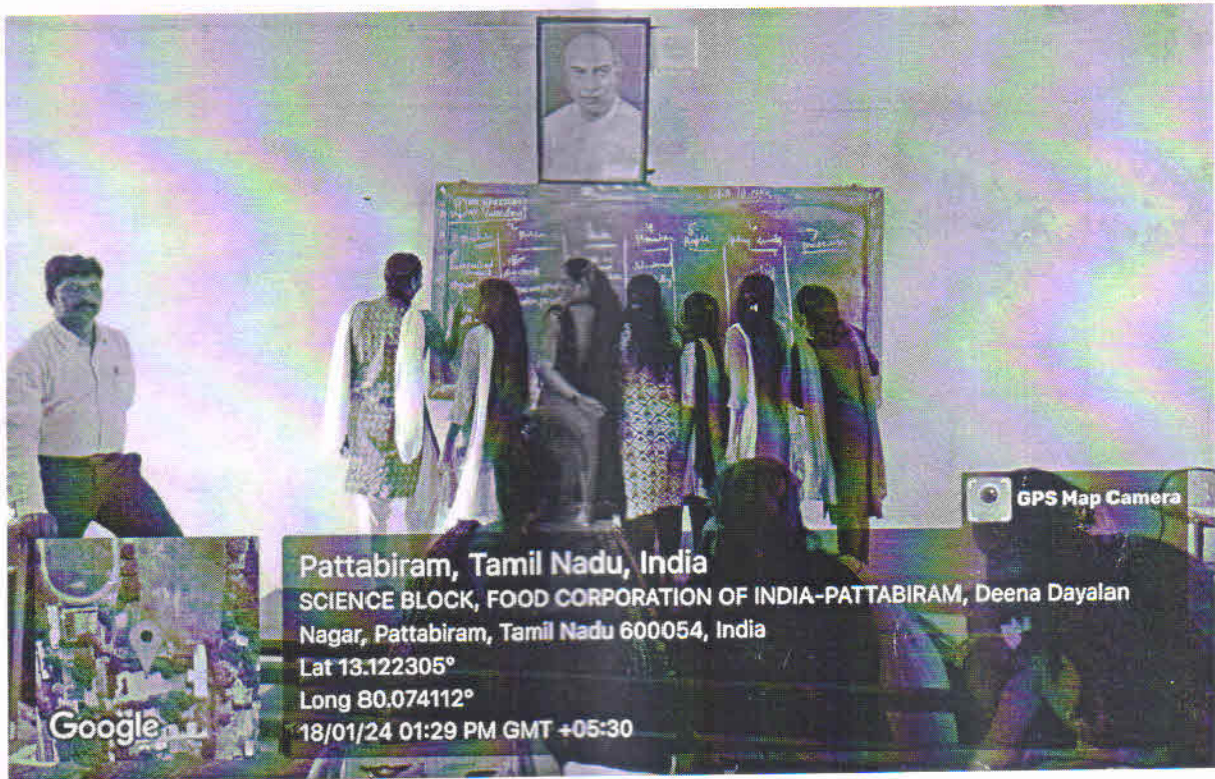

Prof. Indhra M Mandey MBA, M.Phil., M.Com.,
NET/MGTI Head,
Department of Business Administration (Shift-2)
Dharmamurthi Rao Bahadur Calavala Cunnan
Chetty's Hindu College
Pattabiram, Chennai - 600 072



G. Kalinrajan
PRINCIPAL,
DHARMAMURTHI RAO BAHADUR CALAVALA CUNNAN
CHETTY'S HINDU COLLEGE
DHARMAMURTHI NAGAR, PATTABIRAM,
CHENNAI - 600 072.



Pattabiram, Tamil Nadu, India
 SCIENCE BLOCK, FOOD CORPORATION OF INDIA-PATTABIRAM, Deena Dayalan
 Nagar, Pattabiram, Tamil Nadu 600054, India
 Lat 13.121928°
 Long 80.073904°
 18/01/24 01:27 PM GMT +05:30

- 1 A-Abinaya (A.ABINAYA)
 - 2 P. Hamsaveni (R.HAMSAVENI)
 - 3 V. Swathi (V.SWATHI)
 - 4 R. Sowmya (R.SOWMYA)
 - 5 K. Swathi (K.SWATHI)
 - 6 S. Subhara (S.SUBATHRA)
 - 7 V. Kowsalya (V.KOWSALYA)
- Peer Tutor

B. K. K...
 B. K. K...
 Subject Handling
 Faculty

Pra
 HOD

Prof. Indira M Mandev, BBA, M.Phil, M.Com
 NET/IGT Head
 Department of Business Administration (Unit 2)
 Dharmamurthi Rao Bahadur Calavala Cunnan
 Chetty's Hindu College
 Pattabiram, Chennai - 600 072.



G. Kalin...
 PRINCIPAL,
 DHARMAMURTHI RAO BAHADUR CALAVALA CUNNAN
 CHETTY'S HINDU COLLEGE
 DHARMAMURTHI NAGAR, PATTABIRAM,
 CHENNAI - 600 072.



**DHARMAMURTHI RAO BAHADUR CALAVALA
CUNNAM CHETTY'S HINDU COLLEGE**

DEPARTMENT OF BUSINESS ADMINISTRATION (SHIFT-II)

REPORT ON PEER TOURTUTING

ACCOUNTING FOR MANAGERS - II

Day 1: 20/02/2024

TOPIC: RATIO ANALYSE (FINANCIAL OR SOLVENCY RATIO)

Sum No: 29, 30, 31

H/W Sum No: 32, 33



Indhra M Mandey

G. Kalimuthu

**PRINCIPAL,
DHARMAMURTHI RAO BAHADUR CALAVALA CUNNAM
CHETTY'S HINDU COLLEGE
DHARMAMURTHI NAGAR, PATTABIRAM,
CHENNAI - 600 072.**



**Prof. Indhra M Mandey MBA, M.Phil., M.Com.,
NET/IGT Head,
Department of Business Administration (Shift 2)
Dharmamurthi Rao Bahadur Calavala Cunnam
Chetty's Hindu College
Pattabiram, Chennai - 600 072**

DAY 2: 06/03/2024

TOPIC: BUDGETING & BUDGETARY CONTROL (PRODUCTION BUDGET)

Q. No. 1, 2, 17

H/W Sum No: 18, 19, 20



Peer Tutor

S. Charamathi

S. Charamathi



Dr. H-Divya
Subject Handler

Dr. H-DIVYA

HOD

Indhu M Mandley

C. Kalpana

PRINCIPAL

DHARMAMURTHI RAO BAHADUR CHETTY COLLEGE
CHENNAI - 600 072



Geotag Photo

PEER TUTORING



Pattabiram Tamil Nadu
India

28°C

SCIENCE BLOCK, FOOD CORPORATION
OF INDIA-PATTABIRAM, Deena Dayalan

Lat: 13.12 | Long: 80.07

10/01/2024 4:50 PM, IST

MDV Associates

G. Kalinayana

PRINCIPAL
DRECCO HINDU COLLEGE (SINCE 2001)
PATTABIRAM, CHENNAI - 600 072.

PRINCIPAL
4th CROSS
SALAVALA
COLLEGE
PATTABIRAM,
CHENNAI - 600 072.

Google



[Signature]
Head

Department of Mathematics
DRECCO Hindu College (SINCE 2001)
Pattabiram, Chennai - 600 072.

Cen
31/10/23

DEPARTMENT OF
BUSINESS
ADMINISTRATION
[SHIFT-02]

DRBCCC HINDU COLLEGE			
DEPARTMENT OF BUSINESS ADMINISTRATION SHIFT-II			
E-Learning Resources (ODD SEM)			
Dr. H. Divyaa			
2023-2024			
S.NO	YEAR	SEMESTER	SUBJECT
1	I BBA	1 st SEM	PRINCIPLES OF MANAGEMENT
2	II BBA	3 rd SEM	FINANCIAL MANAGEMENT
3	III BBA	5 th SEM	ADVERTISEMENT MANAGEMENT AND SALES PROMOTION

COURSE INSTRUCTOR
Dr. H- DIVYAA

HOD SIGNATURE
Indhira M Mandey

Prof.Indhira M Mandey MBA..M.Phil.. M Com.,
 NET(MGT) Head -
 Department of Business Administration (Shift 2)
 Dharmamurthi Rao Bahadur Calavala Cunnan
 Chetty's Hindu College,
 Pattabiram, Chennai - 600 072.

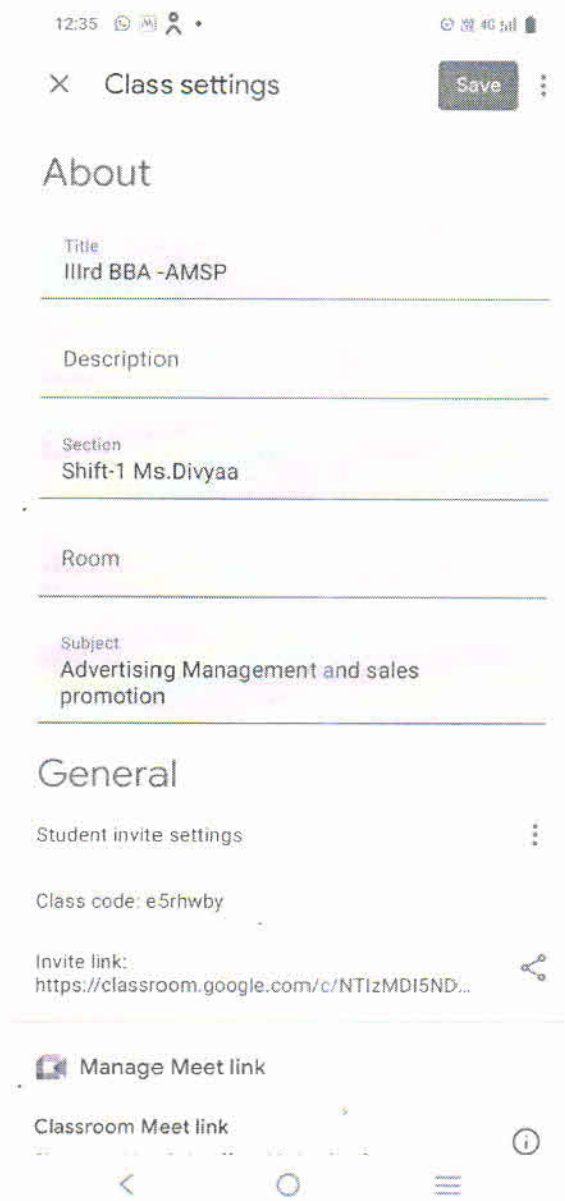
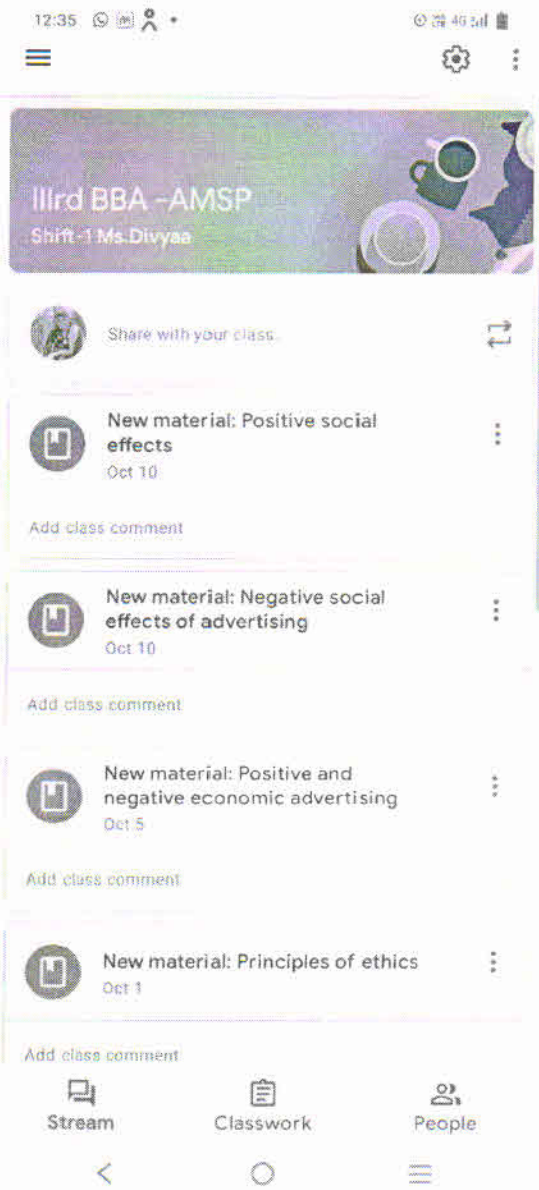

Prof.Indhira M Mandey MBA..M.Phil.. M Com.,
NET(MGT) Head -
Department of Business Administration (Shift 2)
Dharmamurthi Rao Bahadur Calavala Cunnan
Chetty's Hindu College,
Pattabiram, Chennai - 600 072.

Indira

Prof.Indhira M Mandey MBA..M.Phil.. M Com.,
NET(MGT) Head -
Department of Business Administration (Shift 2)
Dharmamurthi Rao Bahadur Calavala Cunnan
Chetty's Hindu College,
Pattabiram, Chennai - 600 072.

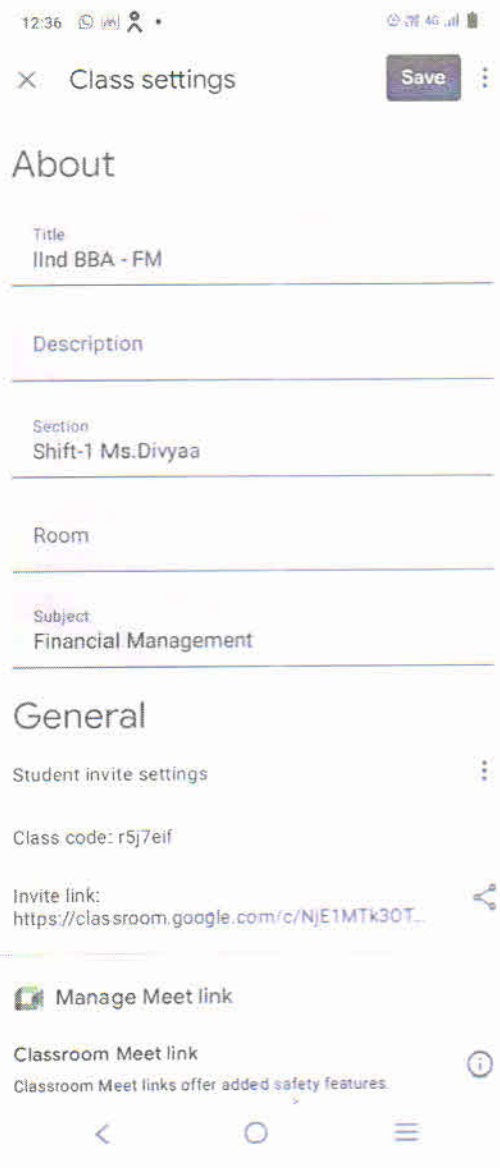
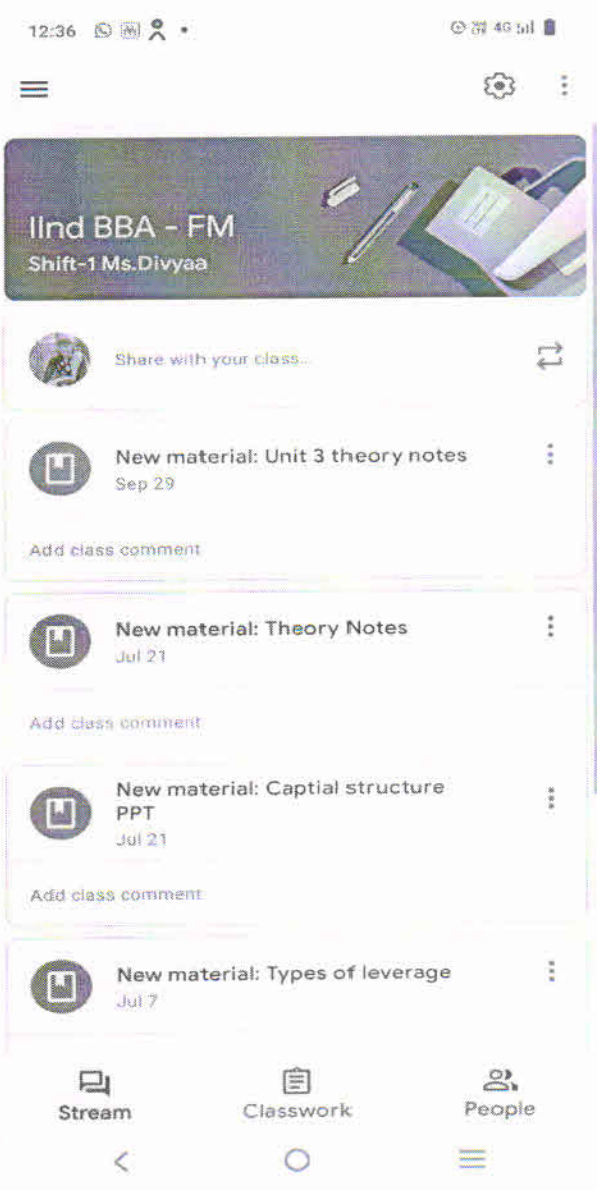

Prof.Indhra M Mandey MBA, M.Phil., M.Com.,
 NET(MGT) Head -
 Department of Business Administration (Shift 2)
 Dharmamurthi Rao Bahadur Calavala Cunnan
 Chetty's Hindu College,
 Pattabiram, Chennai - 600 072.

Prof.Indhra M Mandey MBA, M.Phil., M.Com.,
 NET(MGT) Head -
 Department of Business Administration (Shift 2)
 Dharmamurthi Rao Bahadur Calavala Cunnan
 Chetty's Hindu College,
 Pattabiram, Chennai - 600 072.

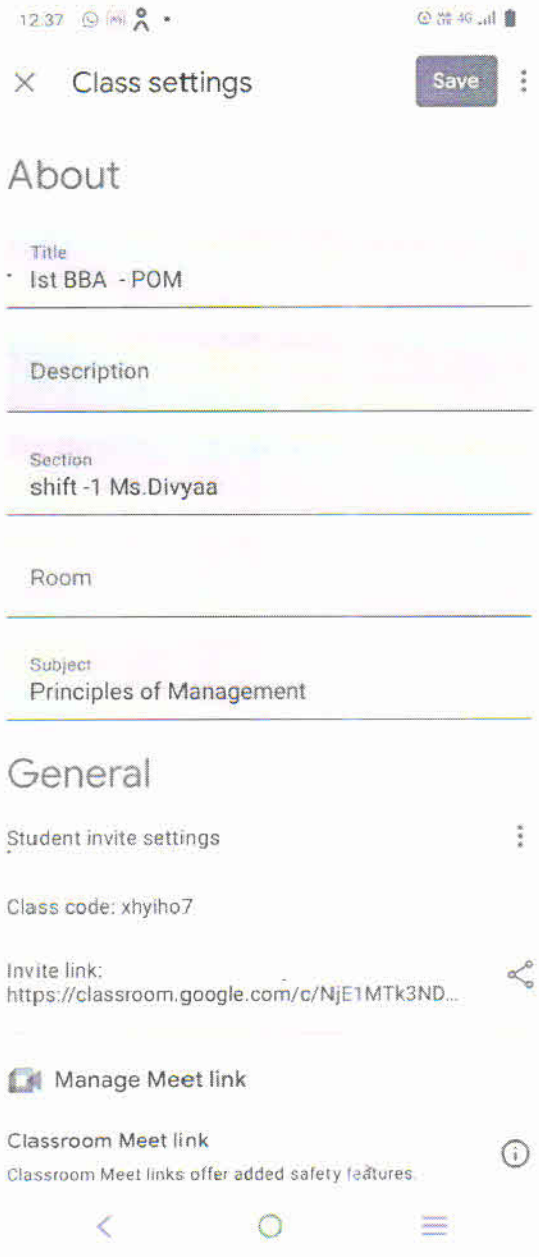
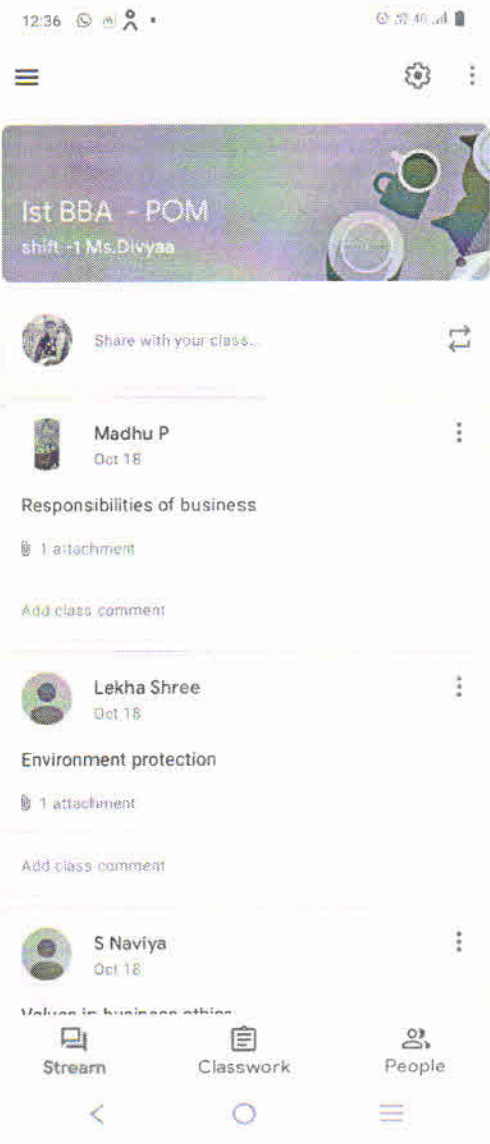

Handwritten signature in blue ink.

Prof.Indhra M Mandey MBA..M.Phil.. M Com.,
NET(MGT) Head -
Department of Business Administration (Shift 2)
Dharmamurthi Rao Bahadur Calavala Cunnan
Chetty's Hindu College,
Pattabiram, Chennai - 600 072.

Prof.Indhra M Mandey MBA..M.Phil.. M Com.,
NET(MGT) Head -
Department of Business Administration (Shift 2)
Dharmamurthi Rao Bahadur Calavala Cunnan
Chetty's Hindu College,
Pattabiram, Chennai - 600 072.

DRBCCC HINDU COLLEGE				
DEPARTMENT OF BUSINESS ADMINISTRATION SHIFT-II				
E-Learning Resources (ODD SEM)				
Dr. B. Kalaiyarasaran				
2023-2024				
S.NO	YEAR	SEMESTER	SUBJECT	RESOURCES
1	I BBA	1 st SEM	EVENT MANAGEMENT	https://classroom.google.com/c/NTMwMjE1MjI2NzI5?cjc=7injoqg
2	II BBA	3 rd SEM	ORGANISATIONAL BEHAVIOUR	https://classroom.google.com/c/NjMyMjUSNzU5MzQz?cjc=a5tir34
3	III BBA	5 th SEM	RESEARCH METHODOLOGY	https://classroom.google.com/c/NTMwMjE0NzU5MzQz?cjc=u3uj5ws



COURSE INSTRUCTOR



HOD SIGNATURE



Prof. Indira M. Mandy, MBA, M.Phil., M.Com.,

NE (MGT) Head -

Department of Business Administration (Shift 2)

Dharmamurthi Rao Bahadur Calavala Cunnan

Chetty's Hindu College,

Pattabiram, Chennai - 600 072.

12:10

4G VoLTE



Share with your class...



New material: RM NOTES
20 Oct



Add class comment



Stream



Classwork



People

12:10

4G VoLTE

Class settings

Save



About

Title

III BBA - (RM) 23-24

Description

Section

Room

Subject

Research Methodology

General

Student invitation settings



Prof. Indhra M. Mandey MBA, M.Phil., M.Com.
NET(MGT) Head -
Department of Business Administration (Shift 2)
Dharmamurthi Rao Bahadur Calavala Cunnar
Dharmamurthi Rao Bahadur Calavala Cunnar
Dharmamurthi Rao Bahadur Calavala Cunnar

Prof. Indhra M. Mandey MBA, M.Phil., M.Com.
NET(MGT) Head -
Department of Business Administration (Shift 2)
Dharmamurthi Rao Bahadur Calavala Cunnar
Dharmamurthi Rao Bahadur Calavala Cunnar

12:08

4G VoLTE

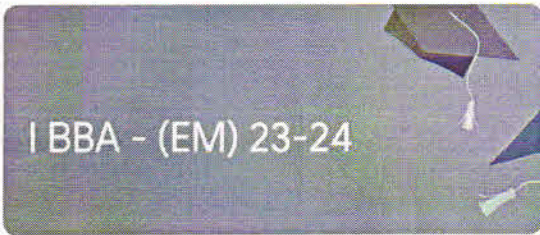

Share with your class...



New material: EVENT MANAGEMENT

20 Oct



Add class comment



Stream



Classwork



People

12:11

4G VoLTE



Class settings

Save



About

Title

I BBA - (EM) 23-24

Description

Section

Room

Subject

EVENT MANAGEMENT

General

Student invitation settings



Prof. Indhra M Mandey MBA, M.Phil., M.Com.,
NET(MGT) Head -
Department of Business Administration (Shift 2)
Dharmamurthi Rao Bahadur Calavala Cunnan
Chetty's Hindu College,
Pattabiram, Chennai - 600 072.

DRBCCC HINDU COLLEGE
DEPARTMENT OF BUSINESS ADMINISTRATION SHIFT-II
E-Learning Resources (ODD SEM)

Prof. Indhra M Mandey

2023-2024

S.NO	YEAR	SEMESTER	SUBJECT	RESOURCES
1	II BBA	3 rd SEM	Marketing Management	https://classroom.google.com/c/NjE1MTk3NzgwNjU4/p/NjE1NjE3MDIxMzly/details
2	III BBA	5 th SEM	Materials Management	https://classroom.google.com/c/NjE1MTk0ODc2MTcy?cjc=no577vm
3	III BBA	5 th SEM	Entrepreneurial Development	https://classroom.google.com/c/NjE1MTk0ODQ3MDQ5?cjc=4lr2cbx



COURSE INSTRUCTOR

(Indhra M Mandey)



HOD SIGNATURE

(Indhra M Mandey)

Prof. Indhra M Mandey MBA, M.Phil., M.Com.,

NET(MGT) Head -

Department of Business Administration (Shift 2)
 Dharmamurthi Rao Bahadur Calavala Cunnan
 Chetty's Hindu College.

16:15

32%

Class settings

Save

About

Title

BBA DRBCCC 2225 MKT MGT

Description

Section

A

Room

3

Subject

Marketing Management

General

Student invitation settings

Class code: tmpptri

Invitation link:

<https://classroom.google.com/c/NjE...>

Manage Meet link

16:16

31%



Share with your class...



Indhra Mandey

2 Oct



Question Bank Marketing

1 attachment

Add class comment



Indhra Mandey

31 Jul



Module 2

1 attachment

Add class comment



Stream



Classwork



People

(Indhra M Mandey)

Prof. Indhra M Mandey MBA, M.Phil., M.Com.,
NET(MGT) Head -
Department of Business Administration (Shift 2)
Dharmamurthi Rao Bahadur Calavala Cunnan
Chetty's Hindu College,
Pattabiram, Chennai - 600 072.

Prof. Indhra M Mandey MBA, M.Phil., M.Com.,
NET(MGT) Head -
Department of Business Administration (Shift 2)
Dharmamurthi Rao Bahadur Calavala Cunnan
Chetty's Hindu College,
Pattabiram, Chennai - 600 072.

16:15

32%

Class settings

Save

About

Title

BBA DRBCCC 2124 MAT

Description

Section

A

Room

1

Subject

Materials Management

General

Student invitation settings

Class code: no577vm

Invitation link:

<https://classroom.google.com/c/NjE...>

Manage Meet link

12:36

4G

4G

Add class comment



New material: Unit-5 notes

Oct 15

Add class comment



New material: Unit -5 Business Ethics

Oct 11

Add class comment



New material: Unit - 4 notes

Sep 26

Add class comment



New material: Unit-3 continues notes of previous topics

Sep 19

Add class comment



New material: Unit 3 final notes

Aug 30

Add class comment



New material: Unit -3 notes

Aug 22

Stream

Classwork

People



Indhra M Mandey

Prof.Indhra M Mandey MBA.,M.Phil., M.Com.,
NET(MGT) Head -
Department of Business Administration (Shift 2)
Dharmamurthi Rao Bahadur Calavala Cunnan
Chetty's Hindu College,
Pattabiram, Chennai - 600 072.

DRBCCC HINDU COLLEGE
DEPARTMENT OF BUSINESS ADMINISTRATION SHIFT-II
E-Learning Resources (ODD SEM)

Dr. A. Kamalakannan

2023-2024

S.NO	YEAR	SEMESTER	SUBJECT	RESOURCES
1	II BBA	3 rd SEM	COMPUTER APPLICATION IN BUSINESS	https://classroom.google.com/c/NjMxOTgzNjI2NzYz?cjc=i32y44t
2	III BBA	5 th SEM	OPERATION MANAGEMENT	https://classroom.google.com/c/NjMxOTgyMjEwNjY2?cjc=imbka5v
3	II BBM	3 rd SEM	MARKETING OF BANKING SERVICE	https://classroom.google.com/c/NjMyMjMwNzY4MDky?cjc=mqqyted



COURSE INSTRUCTOR

(A. Kamalakannan)



HOD SIGNATURE

Indhira M Mandey

Prof. Indhira M Mandey MBA..M.Phil.. M.Com.
NET(MGT) Head -
Department of Business Administration (Shift II)
Dharmamurthi Rao Bahadur Calavala Cunnna
Chattya's Hindu College.

Pattabiram, Chennai - 600 072.

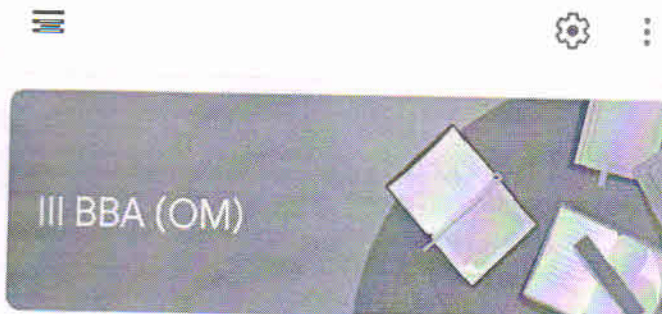

Share with your class...

KAMALAKANNAN A
12:54
OM_Book_Material_reference
1 attachment
Add class comment

KAMALAKANNAN A
12:53
III_BBA_OM Notes
1 attachment
Add class comment

- Stream
- Classwork
- People

16:59 | 19.4KB/s

Class settings Save

About

Title
III BBA (OM)

Description

Section

Room

Subject
Operations Management

General

Student invitation settings

Class code: imbka5v

Invitation link:
<https://classroom.google.com/c/NjMxOTgyMj...>

Manage Meet link

Classroom Meet link
Classroom Meet links offer added safety features.

Handwritten signature in blue ink

Handwritten signature in blue ink

Prof.Indhra M Mandey MBA..M.Phil.. M Com.,
NET(MGT) Head -
Department of Business Administration (Shift 2)
Dharmamurthi Rao Bahadur Calavala Cunnan
Chetty's Hindu College,
Pattabiram, Chennai - 600 072.

Mirrored/bleed-through text from the reverse side of the page, including 'Prof. Indhra M Mandey' and 'Department of Business Administration'.

II BBA (CAB)

Share with your class...

KAMALAKANNAN A
13:34

II_BBA_CAB_Notes-1

1 attachment

Add class comment

New material:
II_BBA_CBA_EDI_Notes
12:51

Add class comment

Stream

Classwork

People



C. Kalinmaraj

PRINCIPAL,
DHARMAMURTHI RAO BAHADUR CALAVALA CUNNAN
CHETTY'S HINDU COLLEGE
DHARMAMURTHI NAGAR, PATTABIRAM,
CHENNAI - 600 072.

Prof. Indhra M. Mandey

Prof. Indhra M. Mandey MBA., M.Phil., M.Com.,
NET (MGT) Part 1 -
Department of Business Administration (Shift 2)
Dharmamurthi Rao Bahadur Calavala Cunnar
Chetty's Hindu College,
Pattabiram, Chennai - 600 072.

16:59 | 0.1KB/s

4G

Class settings

Save

About

Title
II BBA (CAB)

Description

Section

Room

Subject
Computer Application in Business

General

Student invitation settings

Class code: i32y44t

Invitation link:
<https://classroom.google.com/c/NjMxOTgzNjI...>

Manage Meet link

Classroom Meet link

Classroom Meet links offer added safety features.

Prof. Indhra M. Mandey MBA., M.Phil., M.Com.,
NET (MGT) Part 1 -
Department of Business Administration (Shift 2)
Dharmamurthi Rao Bahadur Calavala Cunnar
Chetty's Hindu College,
Pattabiram, Chennai - 600 072.



Geotag Photo

I. B.Sc. C.S. (A)

DNB-7

PEER TUTORING

Head
Department of Mathematics
DRSCCC Hindu College (Shift - 2)
Pattabiram, Chennai - 600 072.

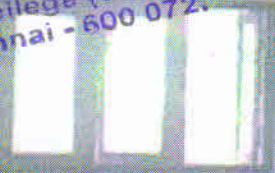

VDV Associates



4th Cro

Google

Hindu College

Pattabiram Tamil Nadu
India

27°C

SCIENCE BLOCK, FOOD
CORPORATION OF

Lat: 13.12 | Long: 80.07
10/01/2024 5:06 PM, IST

2.2

VARIOUS INSTRUCTIONAL TECHNIQUES (ICT TOOLS, BOOKS, LINKS)

Sl.NO	STAFF NAME	SUBJECT	ICT Tool	LINK
1.	Dr. V. Sasikala	Software Engineering	Google Classroom	https://classroom.google.com/c/NjUwNTYxOTU5MDk4?cjc=4ke3wyj
		Python	Google Classroom	https://classroom.google.com/c/MzY0MDUwMjI4MDkx?cjc=z6voyfr
2.	Dr. M. Padmanaban	Cloud Computing	Google Classroom	https://classroom.google.com/c/NjMzMjgyOTg4NDcy
3.	Prof. P. Vinodhini	Software Engineering	Google Classroom	https://classroom.google.com/c/NjIyNjU0ODE0NjI3?cjc=3mzezpx
		Mobile Computing	Google Classroom	https://classroom.google.com/c/NjIyNjU0NTA0NjE1?cjc=5beefnn
4.	Dr. K. Gurumoorthy	Java and Data Structure	Google Classroom	https://classroom.google.com/c/NjTU0NTE4MDE5NDI2?cjc=cieiznd
		Data Science	Google Classroom	https://classroom.google.com/c/NjTIzMTEzOTQ0NjI4?cjc=yu5ihsc
5.	Prof. Prabhakaran S.	Data Science	Google Classroom	https://classroom.google.com/c/NjE1Nzg4NjA1MzIx?cjc=qosjmyo
		Mobile Computing	Google Classroom	https://classroom.google.com/c/NjE1NzkwOTMINTY3?cjc=3bbialw
6.	Prof. S. Mahendran	Computer Organization And Architecture	Google Classroom	https://classroom.google.com/u/1/c/NjE2MDE1MzlwOTU1

G. Kalinraaj
PRINCIPAL,
 DHARMAMURTHI RAO BAHADUR, CALAVALA CUNNAN
 CHETTY'S HINDU COLLEGE
 DHARMAMURTHI NAGAR, PATTADIRAM,
 CHENNAI - 600 072.



ICT TOOLS, BOOKS, LINKS

S.NO	STAFF NAME	SUBJECT	LINK
1.	Dr. V. Sasikala	Software Engineering	https://docs.google.com/presentation/d/1BaB-x6O3IB_iBZ5Uu66ro41SFleDR-A4PEAVTYOugB0/edit?usp=drive link https://docs.google.com/presentation/d/18SfuBCb3J0mCkgsPYHdVFbKJchMLj9G
2.	Prof. S. Prabhakaran	Data Science	https://docs.google.com/document/d/1GsZ6-loqXwDSfWieZmMVZMoJLHrM9RoZvb4V-bGJxil



G. Kalinraj

PRINCIPAL,
DHARMAMURTHI RAO BAHADUR CALAVALA CUNNAM
CHETTY'S HINDU COLLEGE
DHARMAMURTHI RAO PATTABIRAM,
CHENNAI - 600 072.

9.2.20

22

DEPARTMENT OF BCOM ISM

REPORT ON PEER TEACHING

FOR THE ACADEMIC YEAR

2023-2024

DHARMAMURTHI RAO BAHADUR CALAVALA CUNNAN CHETTY'S
HINDU COLLEGE

DEPARTMENT OF B.COM(ISM)

Report on "Peer Teaching"

30/01/2024



Learning Objective:

- To develop communication and presentation skills of the students.
- To foster teamwork and collaboration among peers in teaching and learning.
- To apply management concepts to real-world scenarios through peer-led discussions and activities.

Outcome:

- The BCOM ISM department organized a **Peer Teaching** for second year students on the topic "Principles of Management" on January 30th, 2024 at 3rd .COM ISM classroom. This session was presented by Sivaraam, Lakshmipriya, Swathi, Priyadharshini (3rd year students) under the headship of Dr. Premila Koppalakrishnan.
- Peer teaching encourages active engagement and participation among students, as they take on the role of both teacher and learner. This can enhance their understanding of the material and improve retention.
- Peer teaching fosters collaboration and communication skills, as students work together to explain concepts and provide feedback to their peers, this will not only

strengthens their learning, but also prepares them for real-world situations where teamwork is essential for success.

- Overall, peer teaching can be an effective and enriching educational strategy in the study of management principles.

Feedback responses

- Received 47 responses from 2nd years students

How interactive was the peer teaching session ?

47 responses

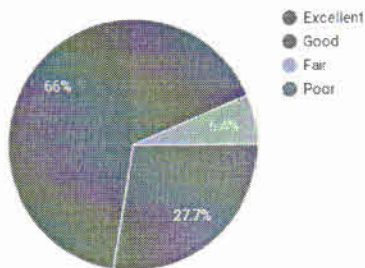

Were your expectations met regarding the session Objective ?

47 responses

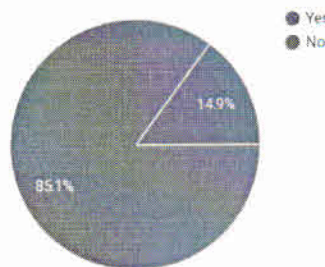

Is it easy to follow and understand

47 responses

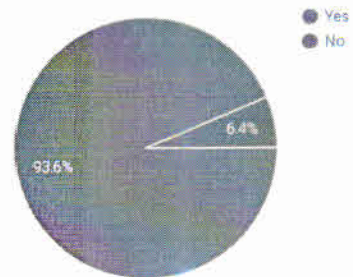

Did the Content of the event was accurately described ?

47 responses

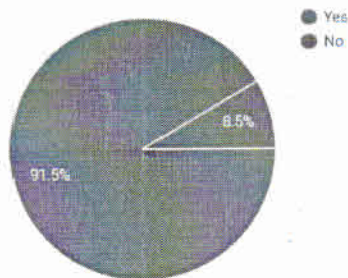

Will you Recommended this type of type of teaching in future ?

47 responses

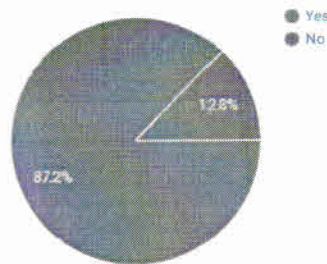



Dharmamurthi Rao Bahadur
Calavala Cunnan Chetty's Hindu College (SHIFT - 2)
(Accredited by NAAC)

Dharmamurthi Nagar, Pattabiram, Chennai - 72
www.drbcchinducollege.ac.in

Degree : **B.Com.I.S.M**

Batch : **2022-2023**

Sl. No.	RollNo	UnivRegNo	Name	
			MALE - Tamil	
1	22IS101	422200046	DEEPAK RAM R	P. Deepak Ram
2	22IS102	422200047	DEEPAK T	T. Deethan
3	22IS103	422200048	DHEEPAK M	AAA
4	22IS104	422200049	GANESH A	Ganesh - A
5	22IS105	422200050	HARIHARAN V	U. Hariharan
6	22IS106	422200051	JITHESH SRINATH R	R. Jithesh
7	22IS107	422200052	JOTHISHWARAN U	U. Jothishwaran
8	22IS108	422200053	KAMALESH BORANA J	J. Kamallesh
9	22IS109	422200054	MANOJ KUMAR J	J. Manoj
10	22IS110	422200056	MOHAMED AZARUDIN ANSARI T	T. Mohamed Azharudin
11	22IS111	422200055	MOHAMED HASSAN FAROOK A	MOHAMED HASSAN FAROOK A
12	22IS112	422200057	MOHAN T	T. Mohan
13	22IS113	422200058	NAVEEN KUMAR M	M. Naveen
14	22IS114	422200059	NAVEEN KUMAR V	V. Naveen
15	22IS115	422200060	PANDEES WARAN A	A. Pandeeswaran
16	22IS116	422200061	RAKESH S	AAA
17	22IS117	422200062	ROHITH C	Rohith C
18	22IS118	422200063	SAMUVEL K	K. Samuvel
19	22IS119	422200064	SOLAI RAJA S	S. Solai Rajan
20	22IS120	422200065	SUDHARSAN KUMAR M	M. Sudharsan
21	22IS121	422200066	TAMILVANAN K	K. Tamilvanan
22	22IS122	422200067	TILIP KUMAR C	C. Tilip Kumar
23	22IS123	422200068	VENKATESH S	AAA
24	22IS124	422200069	VINOTH KUMAR K	K. Vinoth Kumar

Sl. No.	RollNo	UnivRegNo	Name	
FEMALE - Tamil				
25	22IS125	422200070	AATHI SHAKTHI R	R. Athi Shakthi M. Abinaya
26	22IS126	422200071	ABINAYA M	
27	22IS127	422200073	DATCHAYANI G	AAA
28	22IS128	422200074	DEEPIKA N	N. Deepika
29	22IS129	422200075	DEEPIKA S	D. Deepika B. Dhanalakshmi
30	22IS130	422200076	DHANALAKSHMI B	
31	22IS131	422200077	DIVYA B	B. Divya
32	22IS132	422200078	HARI PRIYA G	G. Hari Priya
33	22IS133	422200079	ILUCKYA K	K. Iluckya
34	22IS134	422200080	INDUMATHI S	S. Indumathi
35	22IS135	422200081	JANANEE U	U. Jananee
36	22IS136	422200082	KANMANI S	S. Kanmani
37	22IS137	422200083	KARPAGAM N	N. Karpagam
38	22IS138	422200084	NITHYA B	B. Nithya AAA
39	22IS139	422200085	POOJA S	AAA
40	22IS140	422200086	PRIYADHARSHINI K	AAA
41	22IS141	422200087	PUNITHA G	Punitha G
42	22IS142	422200088	RANJANI P	P. Ranjana
43	22IS143	422200089	SANDHYA DEVI N	N. Sandhya Devi
44	22IS144	422200090	SANGEETHA M	M. Sangeetha
45	22IS145	422200091	SHALINI K	Shalini K
46	22IS146	422200092	SHALINI L	L. shalini
47	22IS148	422200094	SNEKA T G	T. Sneka
48	22IS149	422200096	VAISHNAVI K	K. Vaishnavi
FEMALE - TELUGU				
49	22IS151	422200072	CHAREESHMA SK	AAA
FEMALE - HINDI				
50	22IS150	422200095	SWATHI S	AAA

R
29/1/24

From
Dr.Premila Kopalakrishnan
Head of the Department
Department of Information System Management
DRBCCC Hindu College,
Pattabiram, Chennai- 72

29/01/2024

To
The Director/ Principal,
DRBCCC Hindu College,
Pattabiram, Chennai- 72

Subject: Requesting permission to conduct peer teaching session by final years(IQAC -Advance learners-2.2.1)

Respected Sir/Ma'am

We BCOM (ISM) department are planning to conduct a peer team presentation session of our final years to Sophomore -(2nd Year students) on 30, Jan 2024 from 10 to 12.00 in the management course .
So kindly permit our second years to attend college at 10 am in the morning.

Peer Team (Management course)

Priyadharshini

Lakshmi Priya

Swathi Suresh

Sivaraman

Regards
Dr.Premila Kopalakrishnan



Head of The Department
Information Systems and Management
DHARMAMURTHI RAO BAHADUR CALAVALA
CUNNAN CHETTY'S HINDU COLLEGE
DHARMAMURTHI NAGAR
PATTABIRAM CHENNAI-500 072

C. Annamalai
PRINCIPAL,
DHARMAMURTHI RAO BAHADUR CALAVALA CUNNAM
CHETTY'S HINDU COLLEGE
DHARMAMURTHI NAGAR, PATTABIRAM,
CHENNAI - 600 072.

Department of Statistics

E-Learning Resources

11wlc
7.2.1

S.No.	Name of the book	Link for the book
1.	Statistical Methods for Practice and Research	https://drive.google.com/file/d/1Fr9E4ClrdIOEyELA5kTA5iTTAuVJepdr/view?usp=sharing
2.	Introduction to Probability and Statistics Using R	https://drive.google.com/file/d/0BxTQJz6dVMxZOUFMOGIOcW1GS00/view?usp=sharing&resourcekey=0-hTWr5SJ4Xa777kmBXkQ8og
3.	Statistical Analysis With Excel for Dummies	https://drive.google.com/file/d/1-d7U1cRrL1ET8WoCysseUEmFD_McOJk/view?usp=sharing
4.	Basic Statistics with R	https://drive.google.com/file/d/1FLWFcqyLI7OgRZz-wkP5OBVJzBBaKLEs/view?usp=sharing
5.	Microsoft Excel Functions and Formulas	https://drive.google.com/file/d/1sWf3SaR9Qh7VzLhmACdyvW9DymdKszsj/view?usp=sharing
6.	Introduction to Linear Regression Analysis	https://drive.google.com/file/d/1-RG1tV7gaAK4aEBSj7WChMfeT8TqmPmC/view?usp=sharing
7.	Linear Algebra	https://drive.google.com/file/d/1053nV1mIK9i97JL1bhYV6p5c5rlhzzHa/view?usp=sharing
8.	Introductions to time series analysis and forecasting.	https://drive.google.com/file/d/12sBl-g_KxtSNOqKXLMY7IDwPP-zpPkP/view?usp=drivesdk
9.	Fundamental of mathematical statistics.	https://drive.google.com/file/d/12u2sx1aU5obYFhOap66oFiPEkWWorxVT/view?usp=drivesdk
10.	An introduction to probability and statistics.	https://drive.google.com/file/d/13ExzffBAb4U9r8Oyh5HepcKxLY7d8Cv6/view?usp=drivesdk
11.	Introduction to linear regression analysis.	https://drive.google.com/file/d/139a2NfaR9P04P5iPvxbyllab4guUNJlo/view?usp=drivesdk
12.	Time series analysis and its application with r example.	https://drive.google.com/file/d/13B2ACVKCsxKX_BXquDh7My_lq53_duB8/view?usp=drivesdk
13.	Introductory econometrics.	https://drive.google.com/file/d/137ZR31QIkEzDM8W0k38sid107uRr_tJ5/view?usp=drivesdk

SYSTEMS

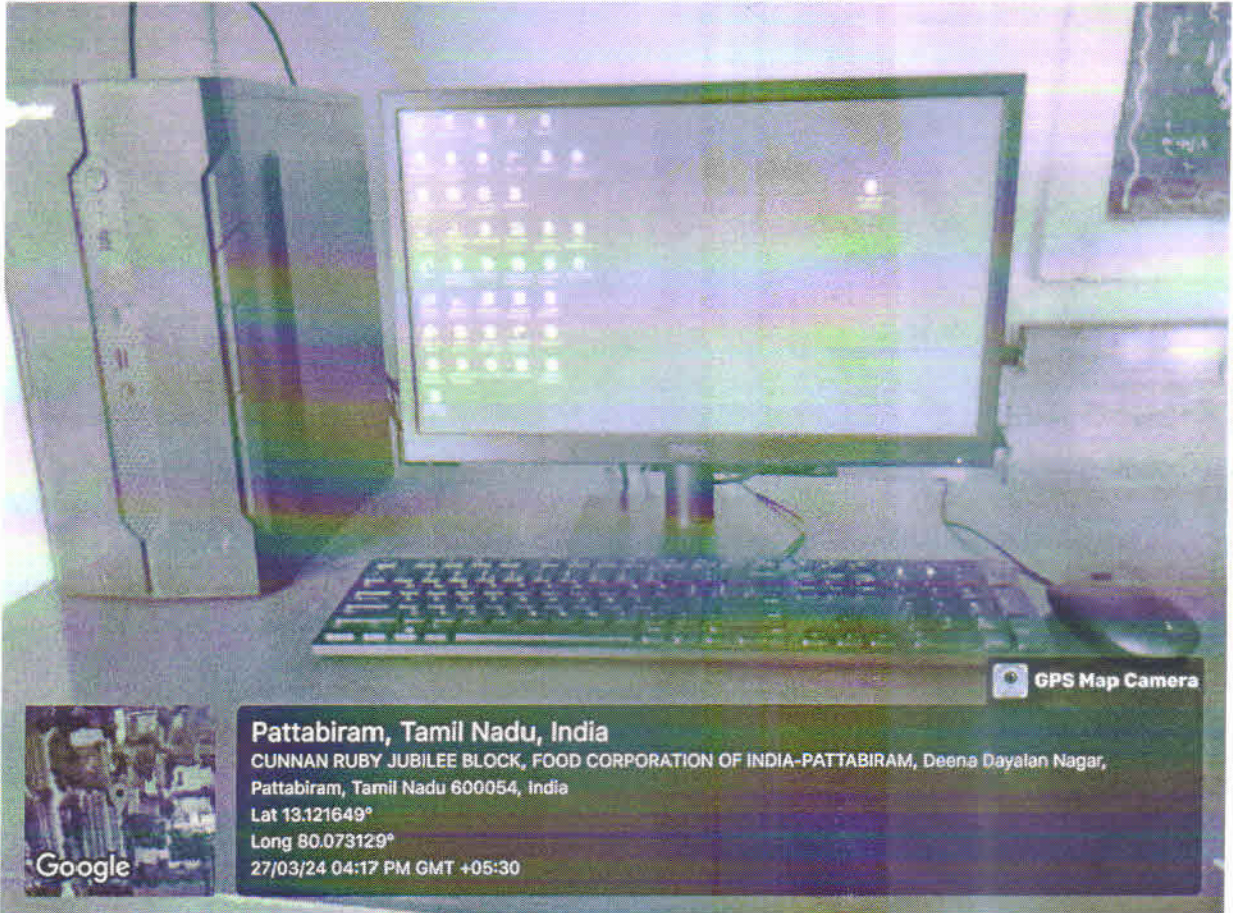

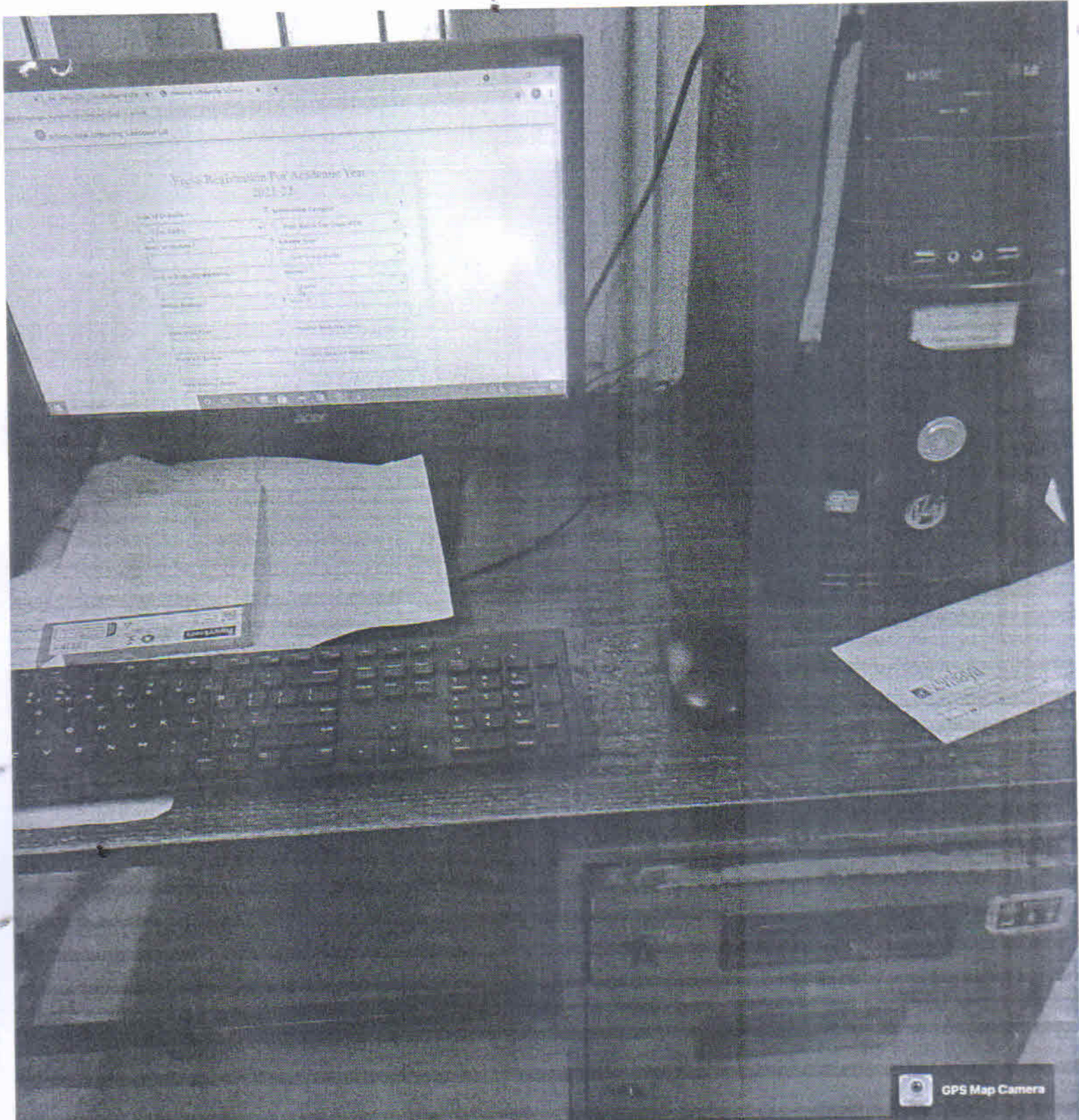

GPS Map Camera



Department of Social Work
Equipment - System DRBCCC HINDU COLLEGE
PATTABIRAM, Tamil Nadu 600054, India
Lat 13.122249°
Long 80.074232°
25/10/21 02:50 PM

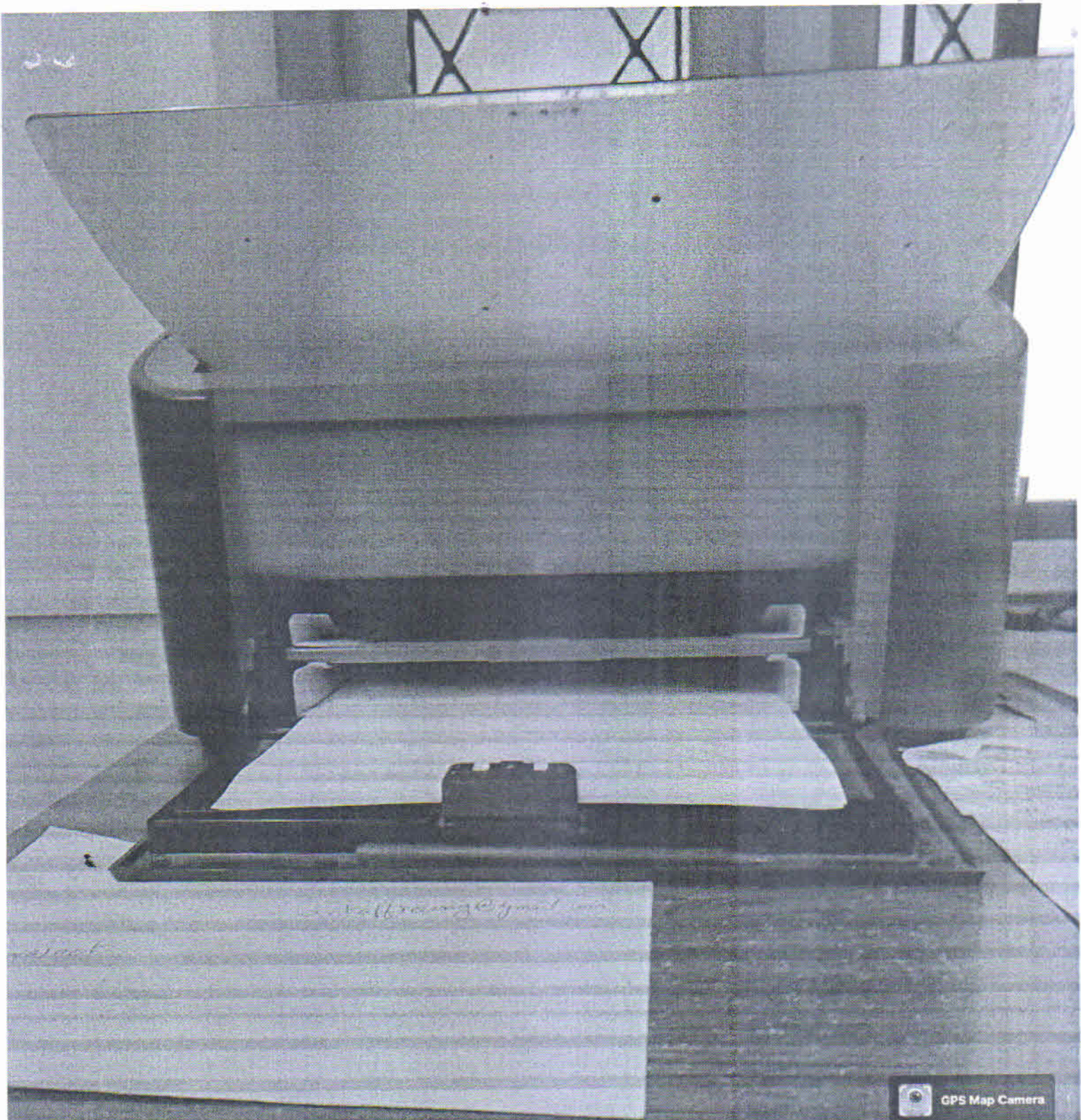

GPS Map Camera



Department of Social Work

Equipment - Printer DRBCCC HINDU COLLEGE

PATTABIRAM, Tamil Nadu 600054, India

Lat 13.122249°

Long 80.074232°

25/10/21 02:50 PM

GPS Map Camera

Pattabiram, Tamil Nadu, India

MSW M&P Classroom 21-22 DRBCCC HINDU COLLEGE PATTABIRAM,

Tamil Nadu 600054, India

Lat 13.122249°

Long 80.074232°

25/10/21 01:34 PM



DRBCCC HINDU COLLEGE

DEPARTMENT OF BUSINESS ADMINISTRATION SHIFT-II

E-Learning Resources (ODD SEM)

Dr. B. Kalaiarasaran

2023-2024

S.NO	YEAR	SEMESTER	SUBJECT	RESOURCES
1	I BBA	1 st SEM	EVENT MANAGEMENT	https://classroom.google.com/c/NTMwMjE1MjI2NzI5?cjc=7injoqg
2	II BBA	3 rd SEM	ORGANISATIONAL BEHAVIOUR	https://classroom.google.com/c/NjMyMjU5NzU5MzQz?cjc=a5tir34
3	III BBA	5 th SEM	RESEARCH METHODOLOGY	https://classroom.google.com/c/NTMwMjE0Nzg1NDkz?cjc=u3uj5ws



COURSE INSTRUCTOR

HOD SIGNATURE

Prof. Indira ... Mandeey MBA, M.Phil., M.Com.
NET(MGT) Head -
Department of Business Administration (Shift 2)
Dharmamurthi Rao Bahadur Calavala Cunnan
Chetty's Hindu College,
Pattabiram - Chennai - 600 072.

12:08

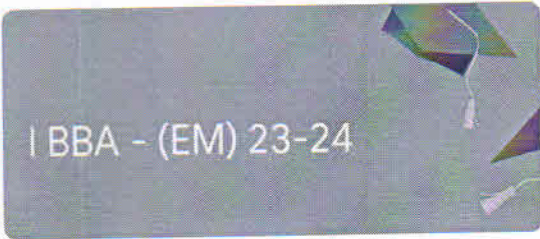
4G VoLTE



Share with your class...



New material: EVENT MANAGEMENT

20 Oct



Add class comment

Stream

Classwork

People

B. W. ...

12:11

4G VoLTE

Class settings

Save



About

Title

I BBA - (EM) 23-24

Description

Section

Room

Subject

EVENT MANAGEMENT

General

Student invitation settings



12:09

4G VoLTE

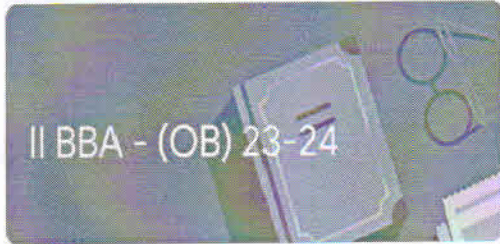

Share with your class...



New material: OB NOTES
20 Oct (Edited 20 Oct)

Add class comment

Stream

Classwork

People

B. Lokeesh



12:11

4G VoLTE

Class settings

Save

About

Title

II BBA - (OB) 23-24

Description

Section

Room

Subject

ORGANISATIONAL BEHAVIOUR

General

Student invitation settings

G. Mahalingam
PRINCIPAL,
DHARMAMURTHI RAO SAHADUR GALAVALA CUNNAM
CHETTY'S HINDU COLLEGE
DHARMAMURTHI NAGAR, PATTABIRAM,
CHENNAI - 600 072.

DRBCCC HINDU COLLEGE				
DEPARTMENT OF BUSINESS ADMINISTRATION SHIFT-II				
E-Learning Resources (ODD SEM)				
Dr. H. Divyaa				
2023-2024				
S.NO	YEAR	SEMESTER	SUBJECT	RESOURCES
1	I BBA	1 st SEM	PRINCIPLES OF MANAGEMENT	https://classroom.google.com/c/NjE1MTk3NDU14Mjgz?cjc=xhyiho7
2	II BBA	3 rd SEM	FINANCIAL MANAGEMENT	https://classroom.google.com/c/NjE1MTk3OTQ3NjU2?cjc=r5j7eif
3	III BBA	5 th SEM	ADVERTISEMENT MANAGEMENT AND SALES PROMOTION	https://classroom.google.com/c/NTIzMDI5NDE4Njg5?cjc=e5rhwby



HOD SIGNATURE
Prof. Indira Mahalingam, M.A., M.Phil., M.Com.,
 NET (MGT) Head -
 Department of Business Administration (Shift-2)
 Dharmamurthi Rao Bahadur Calavala Cunnam
 Chetty's Hindu College,
 Pattabiram, Chennai - 600 072.

COURSE INSTRUCTOR
Dr. H-DIVYAA

12:36

1st BBA - POM
shift -1 Ms.Divyaa

Share with your class...

Madhu P
Oct 18

Responsibilities of business
1 attachment

Add class comment

Lekha Shree
Oct 18

Environment protection
1 attachment

Add class comment

S Naviya
Oct 18

Values in business ethics

Stream Classwork People

12:37

Class settings Save

About

Title
1st BBA - POM

Description

Section
shift -1 Ms.Divyaa

Room

Subject
Principles of Management

General

Student invite settings

Class code: xhyiho7

Invite link:
<https://classroom.google.com/c/NJE1MTk3ND...>

Manage Meet link

Classroom Meet link
Classroom Meet links offer added safety features



Prof.Indhra M Mandey MBA, M.Phil., M Com.,
NET(MGT) Head -
Department of Business Administration (Shift 2)
Dharmamurthi Rao Bahadur Calavala Cunnna
Chetty's Hindu College,
Pattabiram, Chennai - 600 072.

12:35

4G

Google Classroom

IIIrd BBA - AMSP
Shift-1 Ms.Divyaa
58 students

IIInd BBA - FM
Shift-1 Ms.Divyaa
65 students

Ist BBA - POM
Shift-1 Ms.Divyaa
62 students



12:36

4G

Add class comment



New material: Unit-5 notes
Oct 15

Add class comment



New material: Unit -5 Business Ethics
Oct 11

Add class comment



New material: Unit - 4 notes
Sep 26

Add class comment



New material: Unit-3 continues notes of previous topics
Sep 19

Add class comment



New material: Unit 3 final notes
Aug 30

Add class comment



New material: Unit -3 notes
Aug 26

Stream

Classwork

People







12:36 4G

12:36 4G



☰  ⋮

IInd BBA - FM
Shift-1 Ms.Divyaa



 Share with your class... 

 **New material: Unit 3 theory notes**
Sep 29 



Add class comment

 **New material: Theory Notes**
Jul 21 

Add class comment

 **New material: Captial structure PPT**
Jul 21 

Add class comment

 **New material: Types of leverage**
Jul 7 

Stream **Classwork** **People**

< ○ ≡

12:36 4G

12:36 4G

✕ **Class settings** **Save** ⋮

About

Title
IInd BBA - FM

Description

Section
Shift-1 Ms.Divyaa

Room

Subject
Financial Management

General

Student invite settings ⋮

Class code: r5j7eif

Invite link:
<https://classroom.google.com/c/NjE1MTk3OT...> 

 **Manage Meet link**

Classroom Meet link ⓘ
Classroom Meet links offer added safety features

< ○ ≡



Prof. Indhira M. Mandey MBA, M.Phil., M.Com.,
NET/MGT Head -
Department of Business Administration (Shift 2)
Dharmamurthi Rao Bahadur Calavala Cunnan
Chetty's Hindu College,
Pattabiram, Chennai - 600 072.

12:35 4G

Illrd BBA -AMSP
Shift-1 Ms.Divyaa

Share with your class

New material: Positive social effects
Oct 10

Add class comment

New material: Negative social effects of advertising
Oct 10

Add class comment

New material: Positive and negative economic advertising
Oct 5

Add class comment

New material: Principles of ethics
Oct 1

Add class comment

Stream Classwork People

12:35 4G

Class settings Save

About

Title
Illrd BBA -AMSP

Description

Section
Shift-1 Ms.Divyaa

Room

Subject
Advertising Management and sales promotion

General

Student invite settings

Class code: e5rhwbv

Invite link:
<https://classroom.google.com/c/NTIzMDI5ND...>

Manage Meet link

Classroom Meet link

DRBCCC HINDU COLLEGE

DEPARTMENT OF BUSINESS ADMINISTRATION SHIFT-II

E-Learning Resources (ODD SEM)

Dr. A. Kamalakannan

2023-2024

S.NO	YEAR	SEMESTER	SUBJECT	RESOURCES
1	II BBA	3 rd SEM	COMPUTER APPLICATION IN BUSINESS OPERATION	https://classroom.google.com/c/NjMxOTgzNjI2NzYz?cjc=i32y44t
2	III BBA	5 th SEM	MANAGEMENT	https://classroom.google.com/c/NjMxOTgyMjEwNjY2?cjc=imbka5v
3	II BBM	3 rd SEM	MARKETING OF BANKING SERVICE	https://classroom.google.com/c/NjMyMjMwNzY4MDky?cjc=mqqyted

COURSE INSTRUCTOR

Dr - A - D S W A A





PRINCIPAL,
DHARMAMURTHI RAO BAHADUR CALAYALA CUNNAN
CHETTY'S HINDU COLLEGE
DHARMAMURTHI NAGAR, PATTABIRAM,
CHENNAI - 600 072.



HOD SIGNATURE

Prof. Indhra M Mande MBA, M.Phil., M.Com.,
NET(MGT) Head -
Department of Business Administration (Shift 2)
Dharmamurthi Rao Bahadur Calayala Cunnan
Chetty's Hindu College,
Pattabiram, Chennai - 600 072.

☰ ⚙️ ⋮

II BBA (CAB)

Share with your class...

KAMALAKANNAN A
13:54

II_BBA_CAB_Notes-1

1 attachment

Add class comment

New material:
II_BBA_CBA_EDJ_Notes
12:51

Add class comment

Stream Classwork People

10:59 | 0.1KB/s

Class settings Save

About

Title
II BBA (CAB)

Description

Section

Room

Subject
Computer Application in Business

General

Student invitation settings

Class code: i32y44t

Invitation link:
<https://classroom.google.com/c/NjMxOTgzNjI...>

Manage Meet link

Classroom Meet link
Classroom Meet links offer added safety features.

[Signature]

Prof. Indhira M Mandey MBA, M.Phil., M.Com.,
NET/MGT Head -
Department of Business Administration (Shift 2)
Dharmamurthi Rao Bahadur Calavaia Cunnari
Chetty's Hindu College,
Pattabiram, Chennai - 600 072.

16:59 | 19.4KB/s

Class settings Save

About

Title
III BBA (OM)

Description

Section

Room

Subject
Operations Management

General

Student invitation settings

Class code: imbka5v

Invitation link:
<https://classroom.google.com/c/NjMxOTgyMj...>

Manage Meet link

Classroom Meet link
Classroom Meet links offer added safety features.

Stream Classwork People

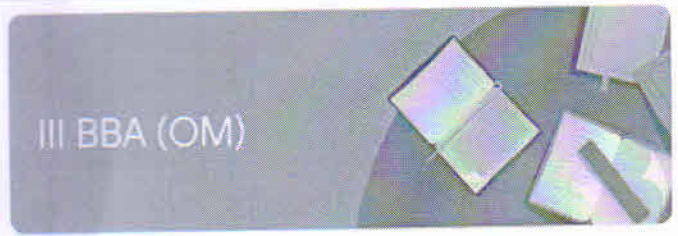

Share with your class...

KAMALAKANNAN A
12:54

OM_Book_Material_reference

1 attachment

Add class comment

KAMALAKANNAN A
12:53

III_BBA_OM Notes

1 attachment

Add class comment



G. Kalinmarai

PRINCIPAL,
DHARMAMURTHI RAO BAHADUR CALAVALA CUNNAN
CHETTY'S HINDU COLLEGE
DHARMAMURTHI NEEDAR, PATTABIRAM,
CHENNAI - 600 072.

Indhra M Mandey

Prof. Indhra M Mandey MBA, M.Phil., M.Com.
NET(MGT) Head -
Department of Business Administration (Shift 2)
Dharmamurthi Rao Bahadur Calavala Cunnan
Chetty's Hindu College,
Pattabiram, Chennai - 600 072.

(Even Sem)

DRBCCC HINDU COLLEGE

DEPARTMENT OF BUSINESS ADMINISTRATION SHIFT-II

E-Learning Resources (EVEN SEM)

Prof. Indhra M Mandey

2023-2024

S.NO	YEAR	SEMESTER	SUBJECT	RESOURCES
1	II BBA	4 th SEM	BUSINESS REGULATORY FRAMEWORK	https://classroom.google.com/c/NjQ2MjgxdY2NjM3?cjc=16x235d
2	III BBA	6 th SEM	CUSTOMER RELATIONSHIP MANAGEMENT	https://classroom.google.com/c/NjQ2MjgxdY2NjM3?cjc=oolzlnq

COURSE INSTRUCTOR

HOD SIGNATURE

Prof. Indhra M Mandey MBA, M.Phil., M.Com.

NET(MGT) Head -

Department of Business Administration (Shift II)

Dharmamuthi Rao Bahadur Calavala Cunnah

Chetty's Hindu College.

Pattabiram, Chennai - 600 072.

Prof. Indhira M Mandey

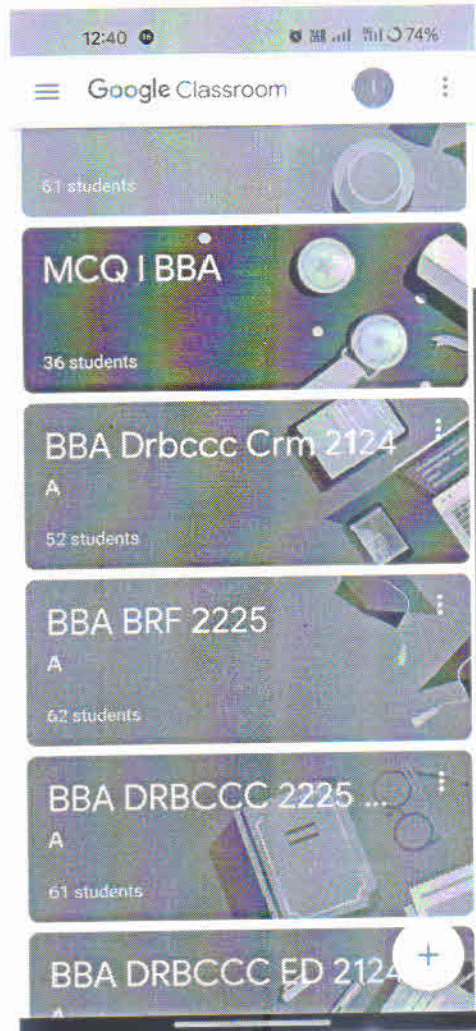
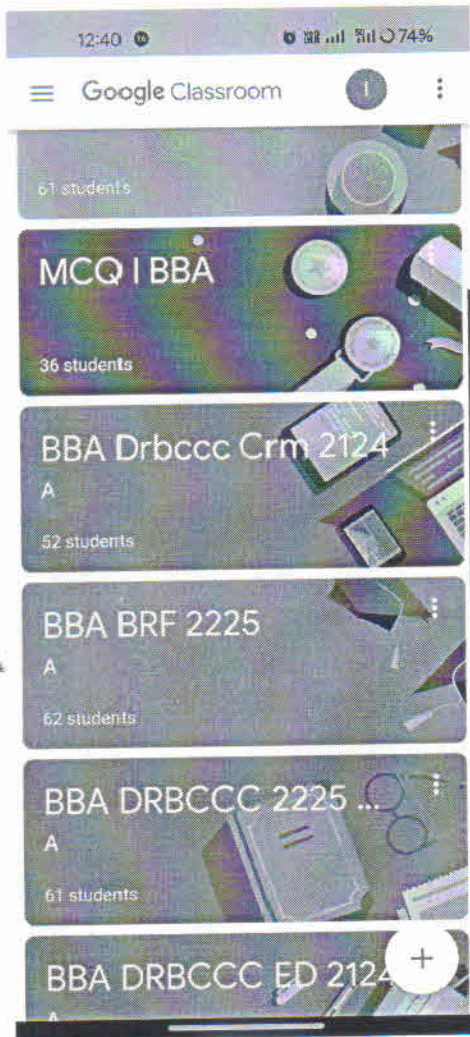

Indhira
Prof. Indhira M Mandey M.Phil. M.Com.
Director, P. G. Arts & Commerce, Shift 2
B. S. P. ...

DRBCCC HINDU COLLEGE
DEPARTMENT OF BUSINESS ADMINISTRATION SHIFT-II
E-Learning Resources (EVEN SEM)
Dr. B. Kalaiyasarasan

2023-2024

S.NO	YEAR	SEMESTER	SUBJECT	RESOURCES
1	I BBA	2 nd SEM	MANAGERIAL SKILLS DEVELOPEMENT	https://classroom.google.com/c/NjUwOTM4NTcwODI2?cjc=yukfvpv
2	II BBA	4 th SEM	HUMAN RESOURCE MANAGEMENT	https://classroom.google.com/c/NjI3ODDA2NTUzZmJmZz?cjc=ac2zc34
3	III BBA	6 th SEM	SERVICES MARKETING	https://classroom.google.com/c/NjUwNDYzMzgzOTU1?cjc=f5ljpjx

COURSE INSTRUCTOR

HOD-SIGNATURE

Prof.Indhira M Mandey MBA, M.Phil., M.Com.
 NET(MGT) Head,
 Department of Business Administration (Shift-II)
 Dharmamurthi Rao Bahadur Calavala College,
 Chetty's Hindu College,
 Pattabiram, Chennai - 600 072.

Dr. B. Kalaiyarasaran

12:30

... [Icons] 4G VoLTE [Battery]

☰ Google Classro...



I BBA - Managerial Skill... ⋮

A

31 students

II BBA 2022-25 ⋮

A

66 students

III BBA 2021-24 ⋮

A

51 students

I BBA - (EM) 23-24



Prof. Indira ...
Department
Dharm

DRBCCC HINDU COLLEGE				
DEPARTMENT OF BUSINESS ADMINISTRATION SHIFT-II				
E-Learning Resources (EVEN SEM)				
Dr. H. Divyaa				
2023-2024				
S.NO	YEAR	SEMESTER	SUBJECT	RESOURCES
1	I BBA	2 nd SEM	ACCOUNTING FOR MANAGERS – II	https://classroom.google.com/c/NjUxMDM0MTY5OTES?cjc=yw3uuoy
2	II BBA	4 th SEM	MANAGEMENT INFORMATION SYSTEM	https://classroom.google.com/c/NjQ5MjgwOTMwNDE0?cjc=7hxqjev
3	III BBA	6 th SEM	BUSINESS ENVIRONMENT	https://classroom.google.com/c/NjQ2MzUxNjgwNzly?cjc=e7dlc3b



COURSE INSTRUCTOR

HOD SIGNATURE

Prof. Vidhya M Mandey MBA, M.Phil., M.Com

NET(MGT) Head -

Department of Business Administration
Dhanamurthi Rao Bahadur Calavala Cultural

Chetty's Hindu College,

Patilwadi, Chennarayana

1st BBA AFM-II (2023-24)

Shift -I Dr.H.Divyaa

45 students

2nd BBA - MIS & PE (SS)

Shift-I Dr.H.Divyaa

66 students

3rd BBA - BE (2023- 24)

Shift-1 Dr.H.Divyaa

58 students

[Handwritten Signature]

Prof. Indira M. Mandey Urs M.Com,
 Department of Commerce,
 Dharmamurthi Rao Bahadur Calavala Cunnan
 Chetty's Hindu College,
 Dharmamurthi Nagar, Pattabiram,
 Chennai - 600 072.



G. Kalinayagi

PRINCIPAL,
 DHARMAMURTHI RAO BAHADUR CALAVALA CUNNAN
 CHETTY'S HINDU COLLEGE
 DHARMAMURTHI NAGAR, PATTABIRAM,
 CHENNAI - 600 072.



DRBCCC HINDU COLLEGE				
DEPARTMENT OF BUSINESS ADMINISTRATION SHIFT-II				
E-Learning Resources (EVEN SEM)				
Prof. P. Lavanya				
2023-2024				
S.NO	YEAR	SEMESTER	SUBJECT	RESOURCES
1	II BBA	2 nd SEM	MARKETING MANAGEMENT	https://classroom.google.com/c/NjQ2NDU2NzE5NTEx?cjc=jhxvavg
2	III BBA	4 th SEM	FINANCIAL SERVICE	https://classroom.google.com/c/NjQ2NDU4MDY0ODIx?cjc=pcuqjvo
3	II BBM	6 th SEM	BUSINESS TAXATION	https://classroom.google.com/c/NjQ2NDU3OTM0OTE2?cjc=myt2pnu

COURSE INSTRUCTOR

HOD SIGNATURE
Prof. Indira M Mandey MBA, M.Phil., M.Com
NET(MGT) Head
Department of Business Administration (Shift 2)
Dharmajurthi Rao Bahadur Calavala Cunnan
Chetty's Hindu College,
Puttur, Chittoor - 522 012



III BBA - BT

47 students

II BBA - FS

69 students

I BBA - MM

39 students

Prof. Indira M. Manjappa, BBA, I Com.

Director, Anna University, Chennai

2.3.2

(ODD SEM)

DRBCCC HINDU COLLEGE
DEPARTMENT OF BUSINESS ADMINISTRATION SHIFT-II
E-Learning Resources (ODD SEM)
Prof. Indhra M Mandey

2023-2024

S.NO	YEAR	SEMESTER	SUBJECT	RESOURCES
1	II BBA	3 rd SEM	Marketing Management	https://classroom.google.com/c/NjE1MTk3NzgwNjU4/p/NjE1NjE3MDIxMzly/details
2	III BBA	5 th SEM	Materials Management	https://classroom.google.com/c/NjE1MTk0ODc2MTcy?cjc=no577vm
3	III BBA	5 th SEM	Entrepreneurial Development	https://classroom.google.com/c/NjE1MTk0ODQ3MDQ5?cjc=4lr2cbx



COURSE INSTRUCTOR



HOD SIGNATURE

Prof. Indhra M Mandey MBA, M.Phil., M.Com.

NET(MGT) Head -

Department of Business Administration (Shift-2)

DRBCCC Hindu College, Pattabiram, Chennai - 600 072

Chetty's Hindu College,

Pattabiram, Chennai - 600 072

16:15

32%

Class settings

Save

About

Title
BBA DRBCCC 2225 MKT MGT

Description

Section
A

Room
3

Subject
Marketing Management

General

Student invitation settings

Class code: tmpptri

Invitation link:
<https://classroom.google.com/c/NjE...>

Manage Meet link

16:16

31%



BBA DRBCCC 2225 MKT ...
A

Share with your class...

Indhra Mandey
2 Oct

Question Bank Marketing

1 attachment

Add class comment

Indhra Mandey
31 Jul

Module 2

1 attachment

Add class comment

Stream

Classwork

People

Prof. Indhra M. Mandey MBA, M.Phil., M.Com.,
NET(MGT) Head -
Department of Business Administration (Shift 2)
Dharmamurthi Rao Bahadur Calavala Cunnan
Chetty's Hindu College,
Pattabiram, Chennai - 600 072.

16:13

33%

Class settings

Save

Title

BBA DRBCCC ED 2124

Description

Section

A

Room

2

Subject

Entrepreneurial Development

General

Student invitation settings

Class code: 4lr2cbx

Invitation link:

<https://classroom.google.com/c/NjE...>

Manage Meet link

Classroom Meet link

Classroom Meet links offer added safety featu

16:16

31%



Indhra Mandey

14 Jul

Module 2

1 attachment

Add class comment



Indhra Mandey

14 Jul

Module 2 blended learning material

1 attachment

Add class comment



New assignment:

Simulation

4 Jul

Add class comment



Indhra Mandey

3 Jul

Marketing notes

1 attachment

Add class comment



Stream



Classwork



People

Prof. Indhra M. Mandey MBA, M.Phil., M.Com.,
NET(MGT) Head -
Department of Business Administration (Shift 2)
Dharmamurthi Rao Bahadur Calavala Cunnan
Chetty's Hindu College,
Pattabiram, Chennai - 600 072.

16:15

32%

Class settings

Save

About

Title
BBA DRBCCC 2124 MAT

Description

Section
A

Room
1

Subject
Materials Management

General

Student invitation settings

Class code: no577vm

Invitation link:
<https://classroom.google.com/c/NjE...>

Manage Meet link

12:36

Add class comment

New material: Unit-5 notes
Oct 15

Add class comment

New material: Unit -5 Business Ethics
Oct 11

Add class comment

New material: Unit - 4 notes
Sep 26

Add class comment

New material: Unit-3 continues notes of previous topics
Sep 19

Add class comment

New material: Unit 3 final notes
Aug 30

Add class comment

New material: Unit -3 notes

Stream

Classwork

People



G. Kalinmanay

PRINCIPAL,
DHARMAMURTHI RAO BAHADUR CALAVALA CUNNAN
CHETTY'S HINDU COLLEGE
DHARMAMURTHI NAGAR, PATTABIRAM,
CHENNAI - 600 072.

[Signature]

Prof. Indra M Mandey MBA, M.Phil., M.Com.,
NET(MGT) Head -
Department of Business Administration (Shift 2)
Dharmamurthi Rao Bahadur Calavala Cunnan
Chetty's Hindu College,
Pattabiram, Chennai - 600 072.

2.3.2

(9)

Google Classroom

Stream Classwork People Grades

Java for 23-24 AI class

Meet Generate link

Class code

Announce something to your class

bsc artificial intelligence posted a new assignment: **Overriding Methods**
Mar 16 (Edited Mar 16)

<https://classroom.google.com/c/NjU3MzlxODg2MzEy?cjc=7zvwlc3>

Google Forms

Classwork People Grades

bsc artificial intelligence posted a new assignment: **Classes and Objects** Due Feb 4

Posted Feb 2 (Edited Feb 2)

0	20	29
Turned in	Assigned	Graded

Classes - Objects - Cons...
Google Forms

Add class comment...

bsc artificial intelligence posted a new assignment: **OOPs Concepts - Quiz 2** Due Jan 27

Posted Jan 25

0	24	25
---	----	----

<https://classroom.google.com/c/NjU3MzlxODg2MzEy/a/NjQ4MTAxMzk5Mjg2/details>

Dr. U. Sri Sath
 Dharmamurthi Rao Bahadur
 Calavala Cunnan Chetty's Hindu College (Smt. S. S. S.),
 Dharmamurthi Nagar,
 Pattabiram, Chennai-600072.

2032

PPT : <https://classroom.google.com/c/NjU3MzlxODg2MzEy/m/NjY3NTcwMjIwNDI4/details>

Classwork People Grades

bsc artificial intelligence posted a new material: Adapter Class

Posted Mar 6

 Adapter Classes.pptx
PowerPoint

Add class comment...

bsc artificial intelligence posted a new material: Java notes (This and super keyword)

Posted Feb 21

Dr. U. Sri Smath

Dharmamurthi Rao Bahadur
Calavala Cunnan Chetty's Hindu Collega (Shift
Dharmamurthi Nagar,
Pattabiram, Chennai-600072.

**DHARMAMURTHI RAO BAHADUR CALAVALA CUNNAN
CHETTY'S HINDU COLLEGE**

PATTTABIRAM, CHENNAI-600 072

**DEPARTMENT OF B.SC COMPUTER SCIENCE WITH
ARTIFICIAL INTELLIGENCE**



ICT Tools Used for Teaching - Python, 2023

Submitted By

Dr.U. Urathal Alias Sri Swathiga

Head of the Department

Report on Varied ICT Tools Used for Teaching

Introduction: Information and Communication Technology (ICT) has revolutionized the field of education, providing diverse tools and platforms to enhance teaching and learning experiences. This report provides an overview of various ICT tools used for teaching, focusing on their impact and benefits in modern educational settings.

1. Learning Management Systems (LMS):

- **Examples:** Google Classroom.
- **Benefits:**
 - Centralized platform for course content delivery.
 - Enables online collaboration, discussion forums, and assignment submissions.
 - Streamlines grading and feedback processes.

2. Interactive Whiteboards:

- **Examples:** SMART Board, Promethean Board.
- **Benefits:**
 - Facilitates dynamic and interactive presentations.
 - Enhances engagement through touch-sensitive surfaces.
 - Enables real-time annotation and collaboration.

3. Video Conferencing Tools:

- **Examples:** Google Meet.
- **Benefits:**
 - Supports virtual classrooms and remote learning.
 - Facilitates live discussions, Q&A sessions, and collaborative projects.
 - Enhances accessibility for geographically dispersed students.

4. Online Assessment Tools:

- **Examples:** Kahoot!, Quizizz, Google Forms.
- **Benefits:**
 - Enables formative and summative assessments.
 - Immediate feedback to students and teachers.
 - Varied question formats for a comprehensive evaluation.

Conclusion: The integration of varied ICT tools in teaching has transformed traditional educational methods, providing educators with dynamic resources to cater to diverse learning styles and preferences. The continuous exploration and implementation of these tools

contribute to a more engaging, inclusive, and effective educational experience for both teachers and students.

This report highlights the importance of embracing ICT tools and leveraging their potential to create innovative and impactful teaching and learning environments. Ongoing professional development and adaptability are essential to maximizing the benefits of these tools in the ever-evolving landscape of education.

Google Class Room Link:

<https://classroom.google.com/c/NTIzMTc4NTczMjAx?cjc=5n7vtxf>

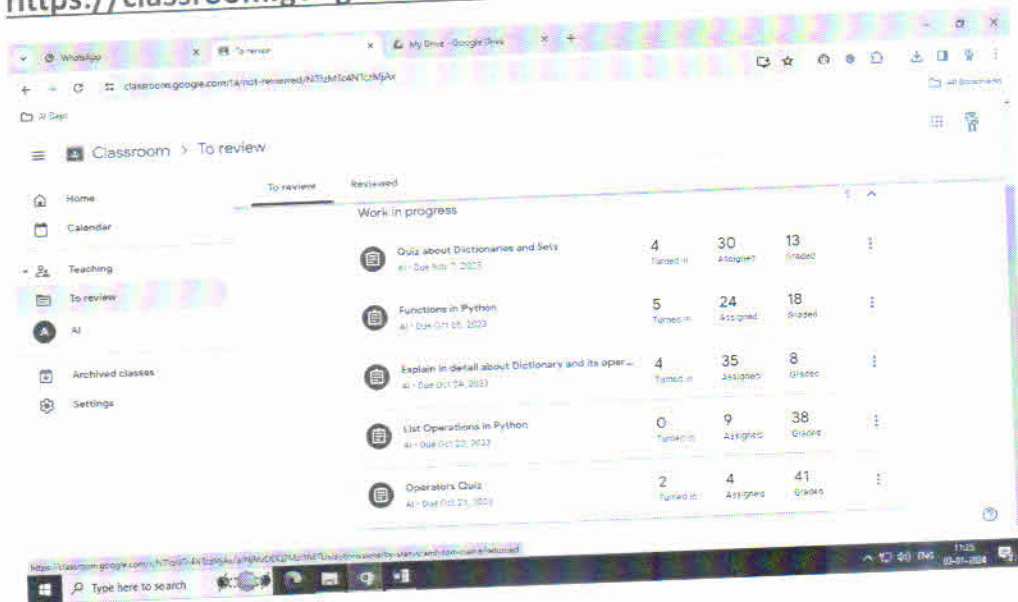

Interactive White Board

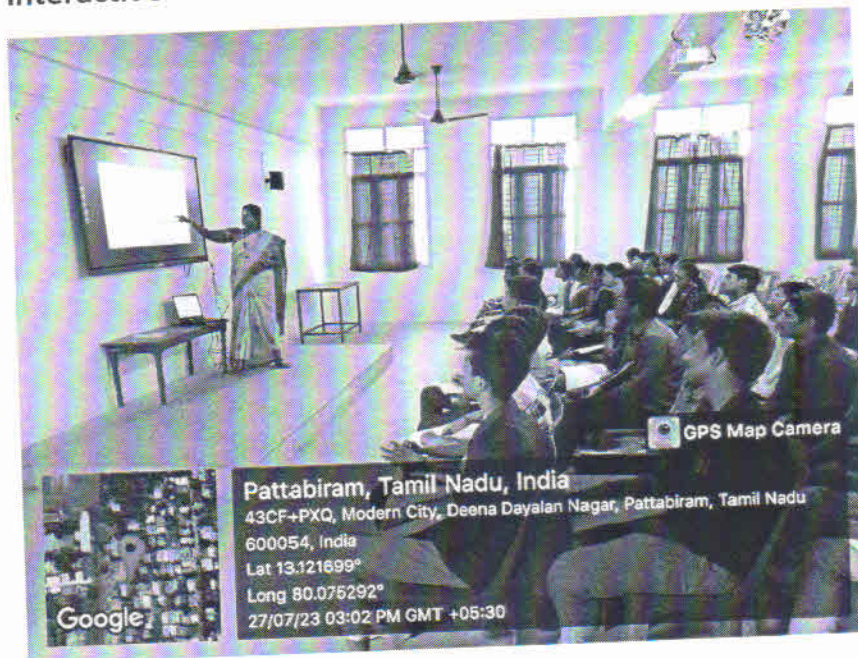

White Board Class

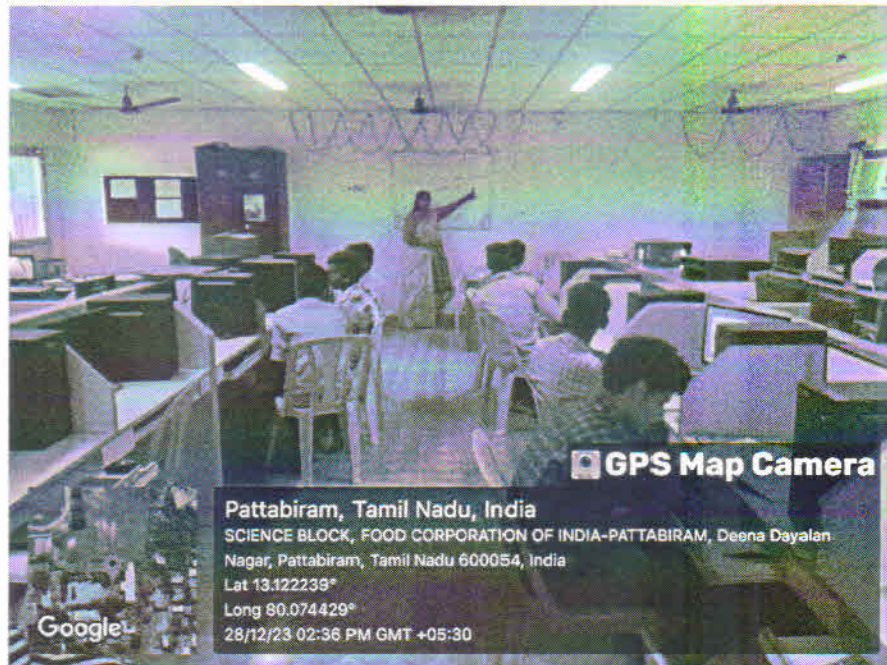

Quizziz

Name	Value
Game Started On	Tue 18 Jul 2023,04:23 PM
Game Type	Homework
Class name(s)	AI
Participants	21
Total Attempts	21
Class Accuracy	76%
Game Ends On	Thu 20 Jul 2023,12:47 AM

QUIZZZ

Google Forms - <https://docs.google.com/forms/d/1v-CX50JxzeiOI8CMNbn7V37Ev0XE8d7PaurxKjIHyeCE/edit#responses> 1/1

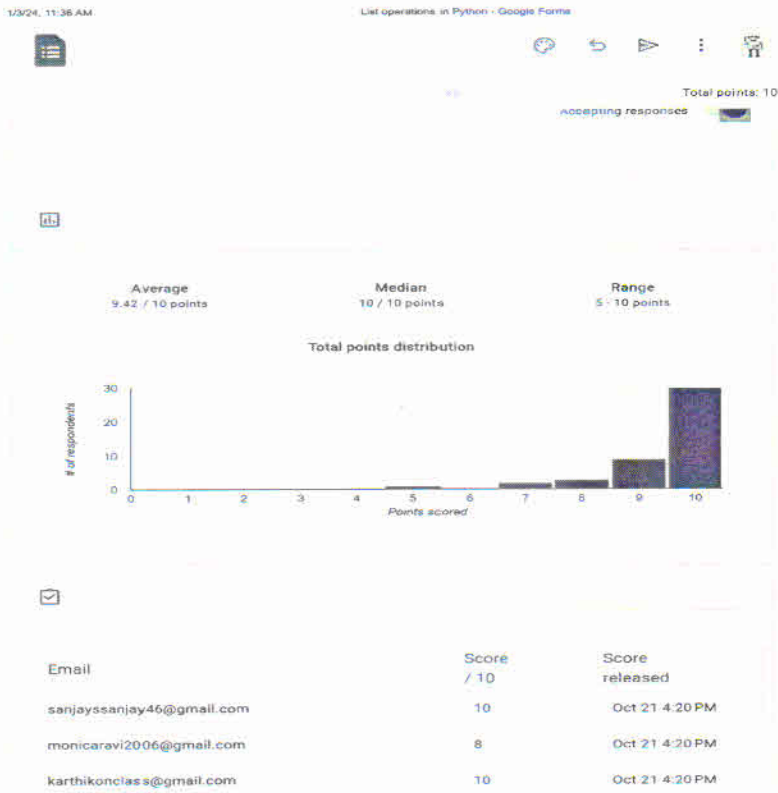

Projector Class



Dharmamurthi Rao Bahadur
Jalavaia Cunnan Chetty's Hindu College (Shri 2)
Dharmamurthi Nagar,
Pattabiram, Chennai-600072.

U. S. S. Smalt
HOD

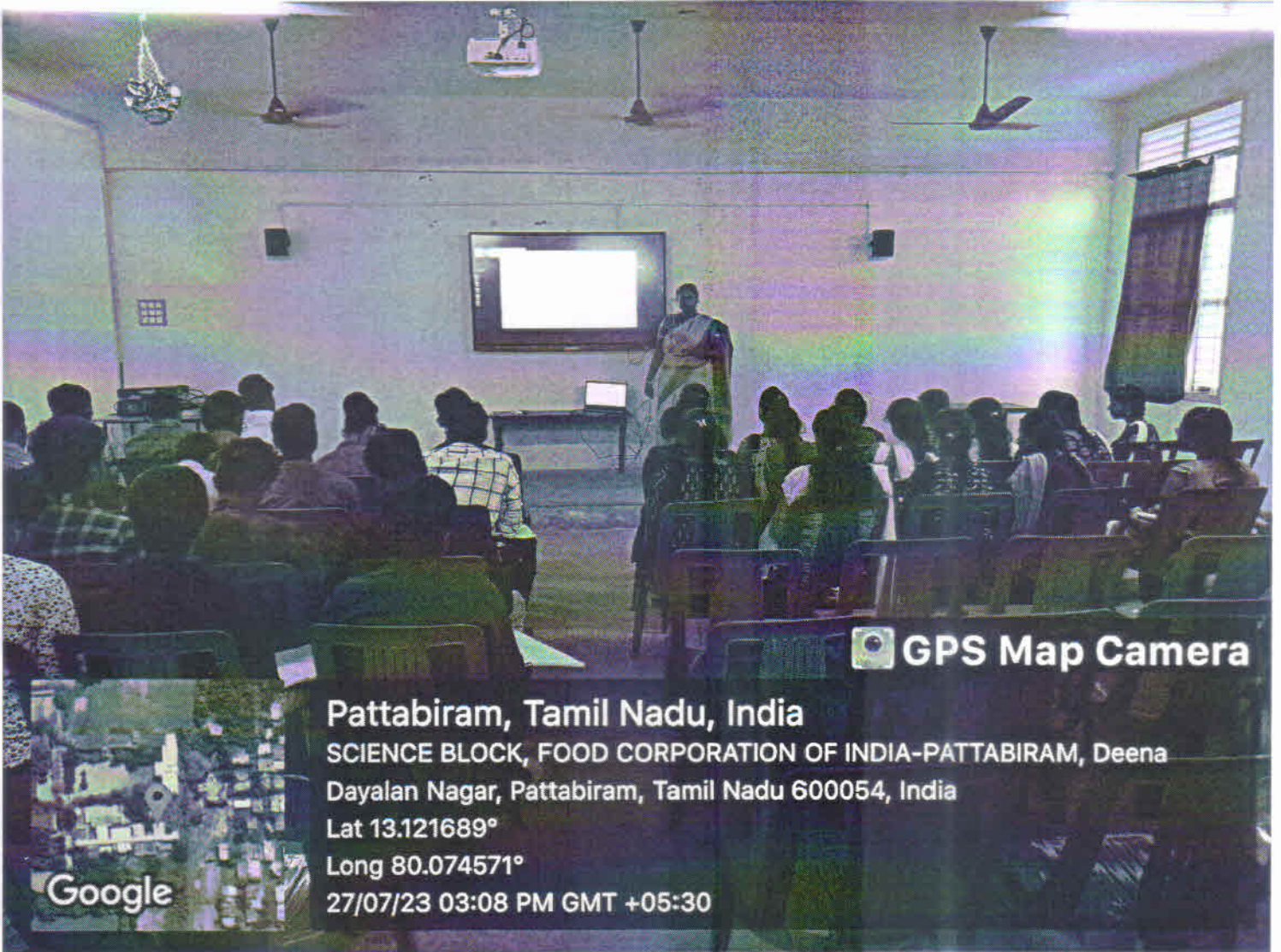

D. U. Srinivasan

Dharmamurthi Rao Bahadur
Calavala Cunnan Chetty's Hindu College (Sri...
Dharmamurthi Nagar,
Pattabiram, Chennai-600072.

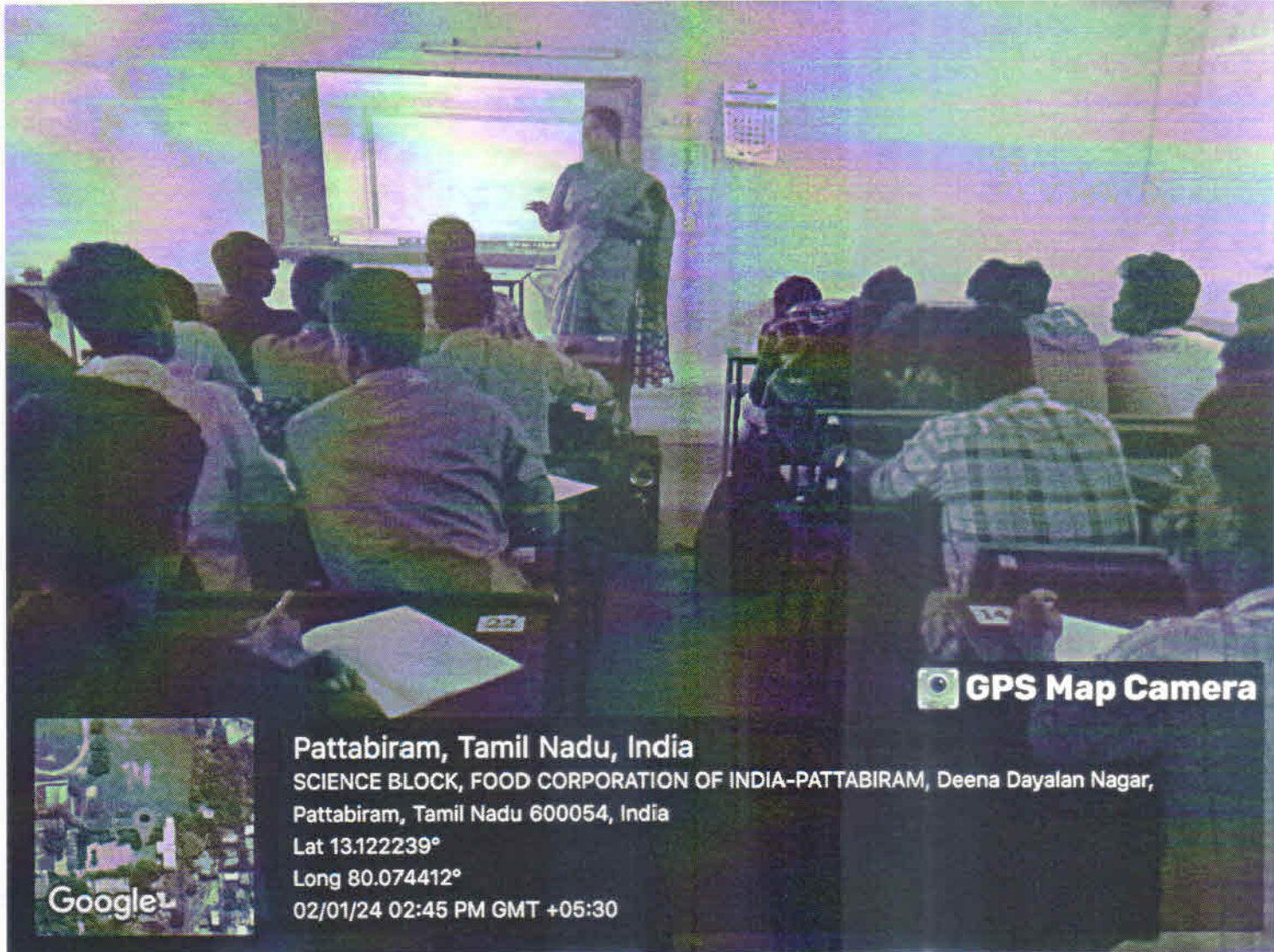

 **GPS Map Camera**



Google

Pattabiram, Tamil Nadu, India

SCIENCE BLOCK, FOOD CORPORATION OF INDIA-PATTABIRAM, Deena Dayalan Nagar,
Pattabiram, Tamil Nadu 600054, India

Lat 13.122239°

Long 80.074412°

02/01/24 02:45 PM GMT +05:30

Dr. U. Sri Smath

Dharmamurthi Rao Bahadur
Calavala Cunnan Chetty's Hindu College (SHIN 2)
Dharmamurthi Nagar,
Pattabiram, Chennai - 600072



U. Smath
PRINCIPAL,
DHARMAMURTHI RAO BAHADUR CALAVALA CUNNAN-
CHETTY'S HINDU COLLEGE
DHARMAMURTHINAGAR, PATTABIRAM,
CHENNAI - 600072.

2.3.2

Report

Frequency of ICT Tool Usage:

- Over 90% of staff reported using ICT tools on a daily basis.
- Approximately 80% of staff reported using projectors at least once a week for presentations, meetings, or training sessions.
- Google classroom (Materials and links are shared)
- Email remains the most commonly used tool, followed by Microsoft Office Suite (Word, Excel, PowerPoint).

Projectors play a significant role in facilitating presentations, meetings, and training sessions within our organization. While staff members generally express satisfaction with their usage, there are notable challenges such as technical issues and lack of training on advanced functionalities. By addressing these challenges and implementing suggested improvements, the organization can maximize the effectiveness of projectors in supporting staff operations.

In addition to Information and Communication Technology (ICT) tools, projectors have become an integral part of modern workplaces, facilitating presentations, meetings, and training sessions.

Photos:

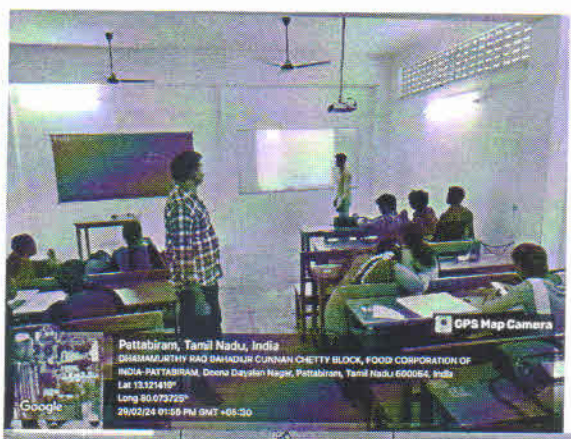



II BSC COMPUTER S...

B



Business Statistics

II B.com: C Sec



R Programming Work...

GNANASEKAR KALAM



Machine Learning for...

26- 31 July 2021

E&ICT Academy IIT-Guwahati



 Customize

BBA. Statistics

 Announce something to your class



 Devi Devi
Mar 9



M.Homalakshmi(22BA154)



M.Homalakshmi (2...
PDF

 Add class comment...



 ABINAYA N
Mar 9



N.ABINAYA

- 22BA170



IMG_20240309_13...
PDF



Stream Classwork People Grades



Sandhya Sandhya
Mar 8



R.Sandhya
22BA169



R.Sandhya 22BA169...
PDF



Add class comment...



Dharshini 22
Mar 8



P.Dharshini
22BA148



P Dharshini 22BA14...
PDF



Add class comment...



Karthi K
Mar 8



K. Karthi 22BA115 OR Assignment



Drive file
Unknown File



Add class comment...





Stream

Classwork

People

Grades

Oct 21, 2023

Ishwarya R posted a new material: 6
Oct 21, 2023



Ishwarya R posted a new material: 5
Oct 21, 2023



Ishwarya R posted a new material: 4
Oct 21, 2023



Ishwarya R posted a new material: 3
Oct 21, 2023



Ishwarya R posted a new material: 2
Oct 21, 2023



Ishwarya R posted a new material: 1
Oct 21, 2023



Ishwarya R posted a new material: Qp
Oct 21, 2023 (Edited Oct 21, 2023)



2.3.2 Innovation Teaching
Youtube channel Dept of ECS

7.2.1

← gopinath annamalai × 🔊 📺 ⋮

 Gopinath Annamalai
646 subscribers · 184 videos
SUBSCRIBE

Latest from Gopinath Annamalai

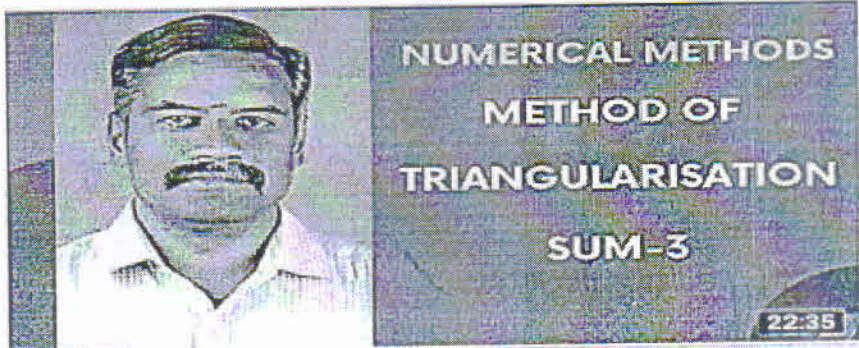
 NUMERICAL METHODS
METHOD OF
TRIANGULARISATION
SUM-3
22:35

 Method of Triangularisation-Sum-3
Gopinath Annamalai · 24 views · 1 week ago

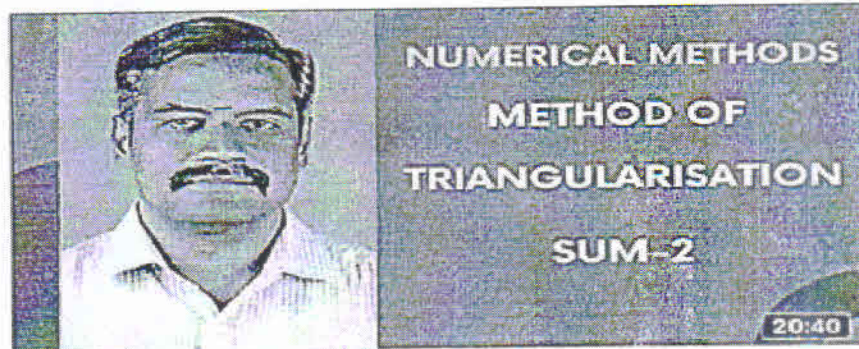
 NUMERICAL METHODS
METHOD OF
TRIANGULARISATION
SUM-2
20:40

Home Shorts + Subscriptions Library

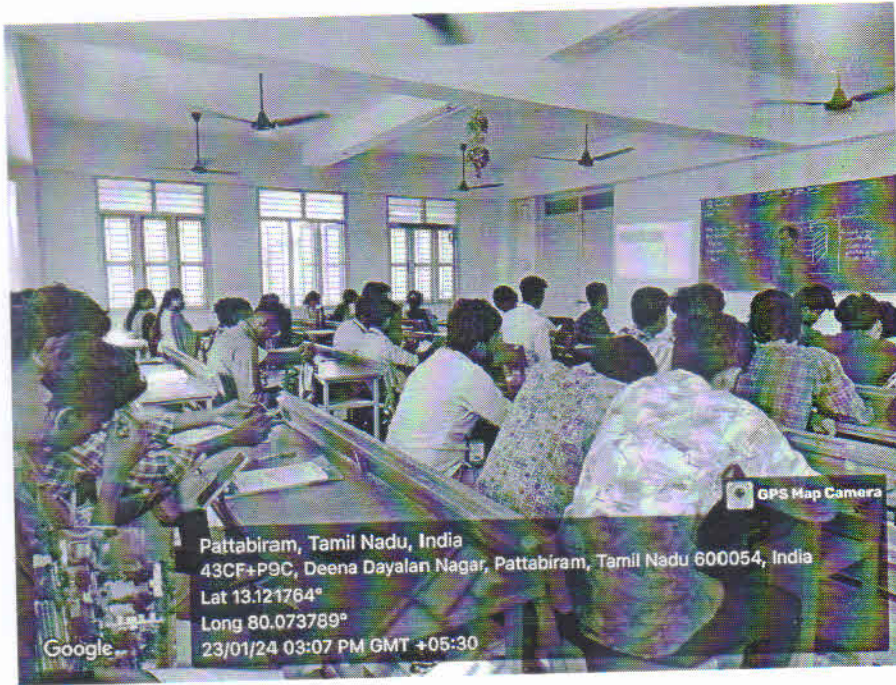

Assistant Professor and Head
Department of Electronics and
Communication Science
DRBCCC Hindu College
Pattabiram, Chennai - 600 072.

PPT



8085 - Simulator Program



Assistant Professor and Head
Department of Electronics and
Communication Science
DRBCCC Hindu College
Pattabiram, Chennai - 600 072.

Seminar

FEATURES

- GPS extends the GSM Packet circuit switched data capabilities and makes the following services possible
- Web browsing and broadcasting
- "Always on" Internet access
- Multimedia messaging service (MMS)
- Push-to-talk over cellular (PTT)
- Location mapping and provision - whole or village

 **GPS Map Camera**

Pattabiram, Tamil Nadu, India

43CG+HFV, Arjun Main Rd, Modern City, Deena Dayalan Nagar,

Pattabiram, Tamil Nadu 600054, India

Lat 13.121564°

Long 80.076715°

20/10/23 01:08 PM GMT +05:30

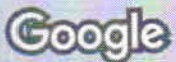



Assistant Professor

Department of Electronics

Communication Science

DRBCCC Hindu College
Pattabiram, Chennai - 600 072.

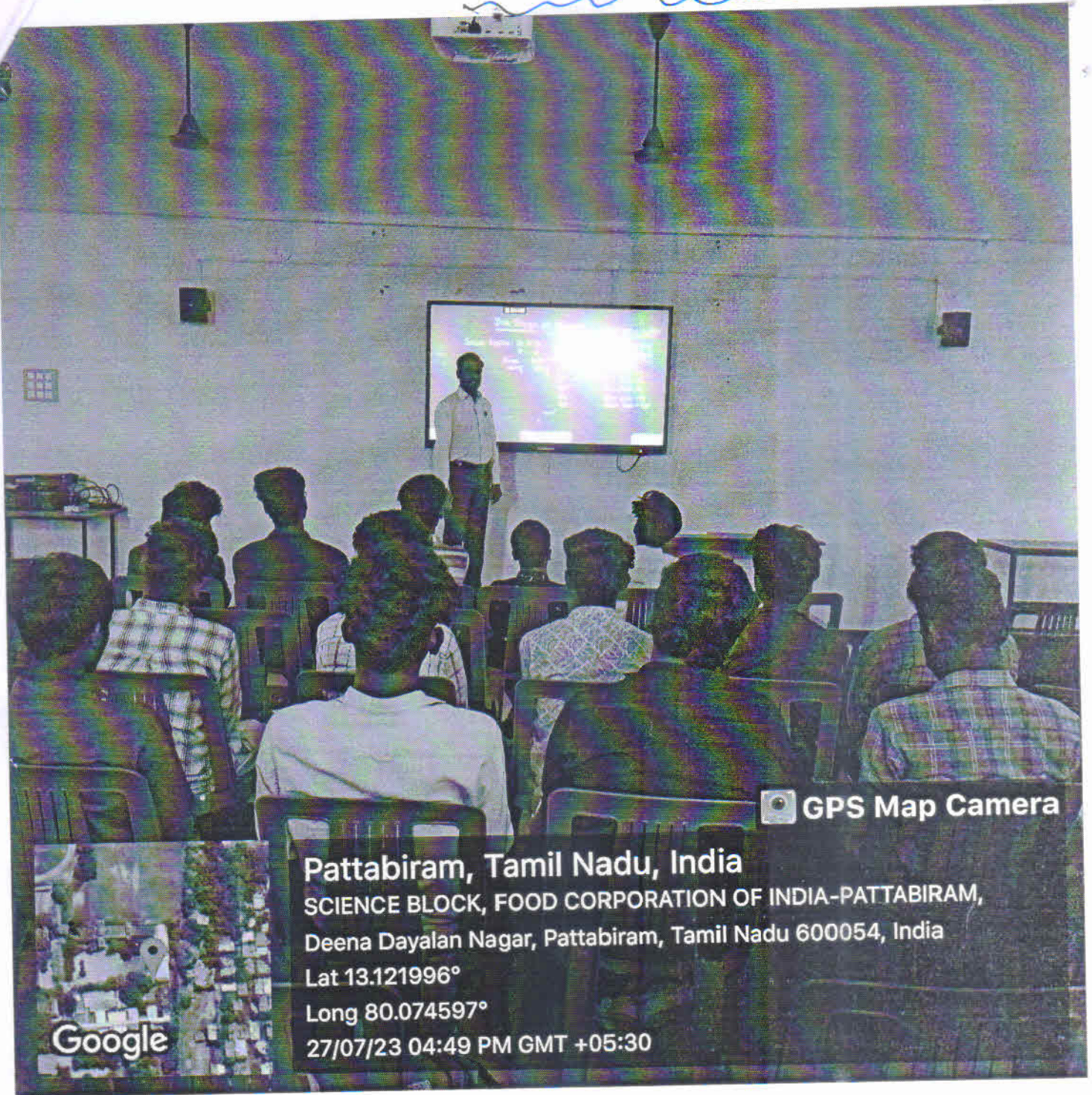
Smart Cam



GPS Map Camera

Pattabiram, Tamil Nadu, India
SCIENCE BLOCK, FOOD CORPORATION OF INDIA-PATTABIRAM,
Deena Dayalan Nagar, Pattabiram, Tamil Nadu 600054, India
Lat 13.121996°
Long 80.074597°
27/07/23 04:49 PM GMT +05:30

Google

S. Srinivasan
Assistant Professor and Head
Department of Electronics and
Communication Science
DRBCCC Hindu College
Pattabiram, Chennai - 600 072.

8085 Simulator

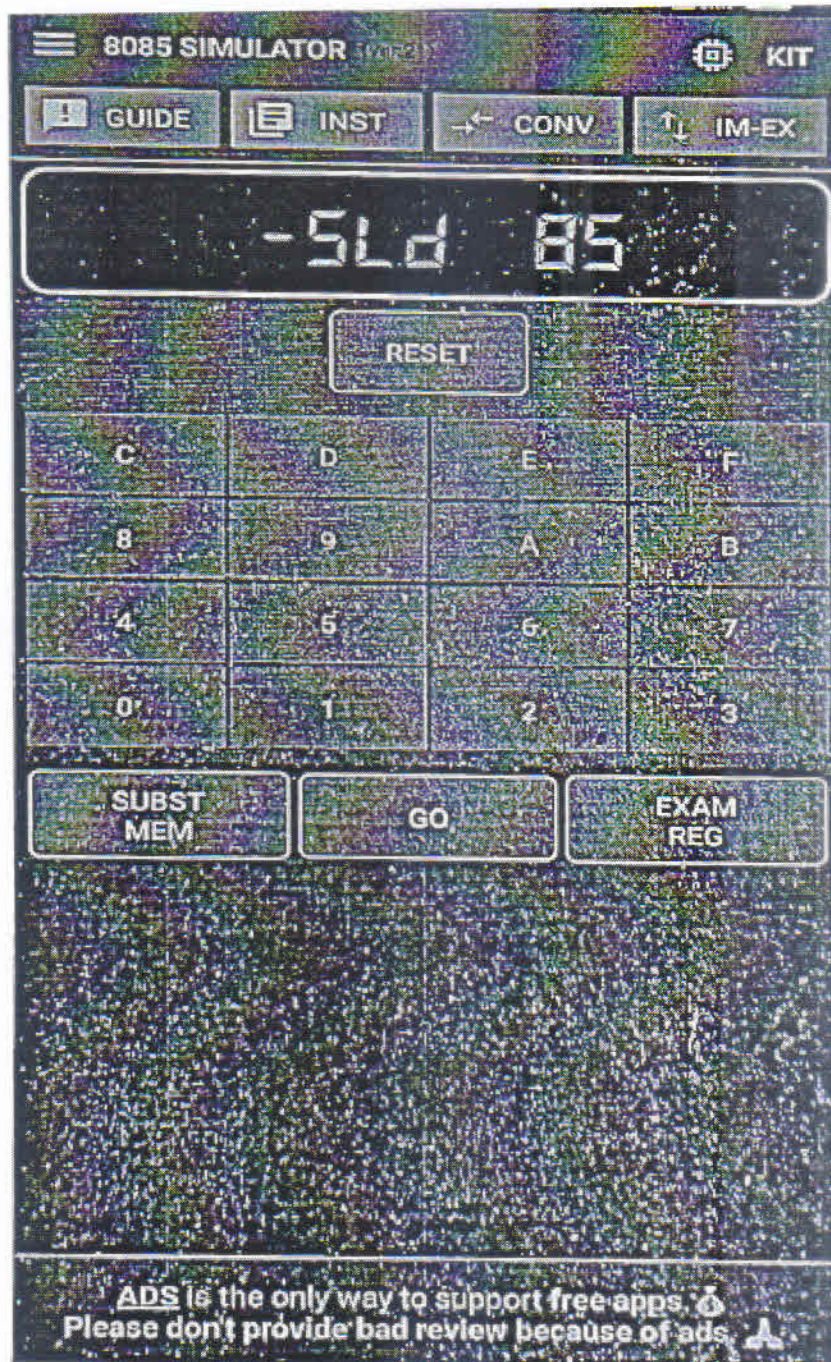

S. Srinivas
Assistant Professor and Head
Department of Electronics and
Communication Science
DRBCC Hindu College
Pattabiram, Chennai - 600 072.

Arduino Program

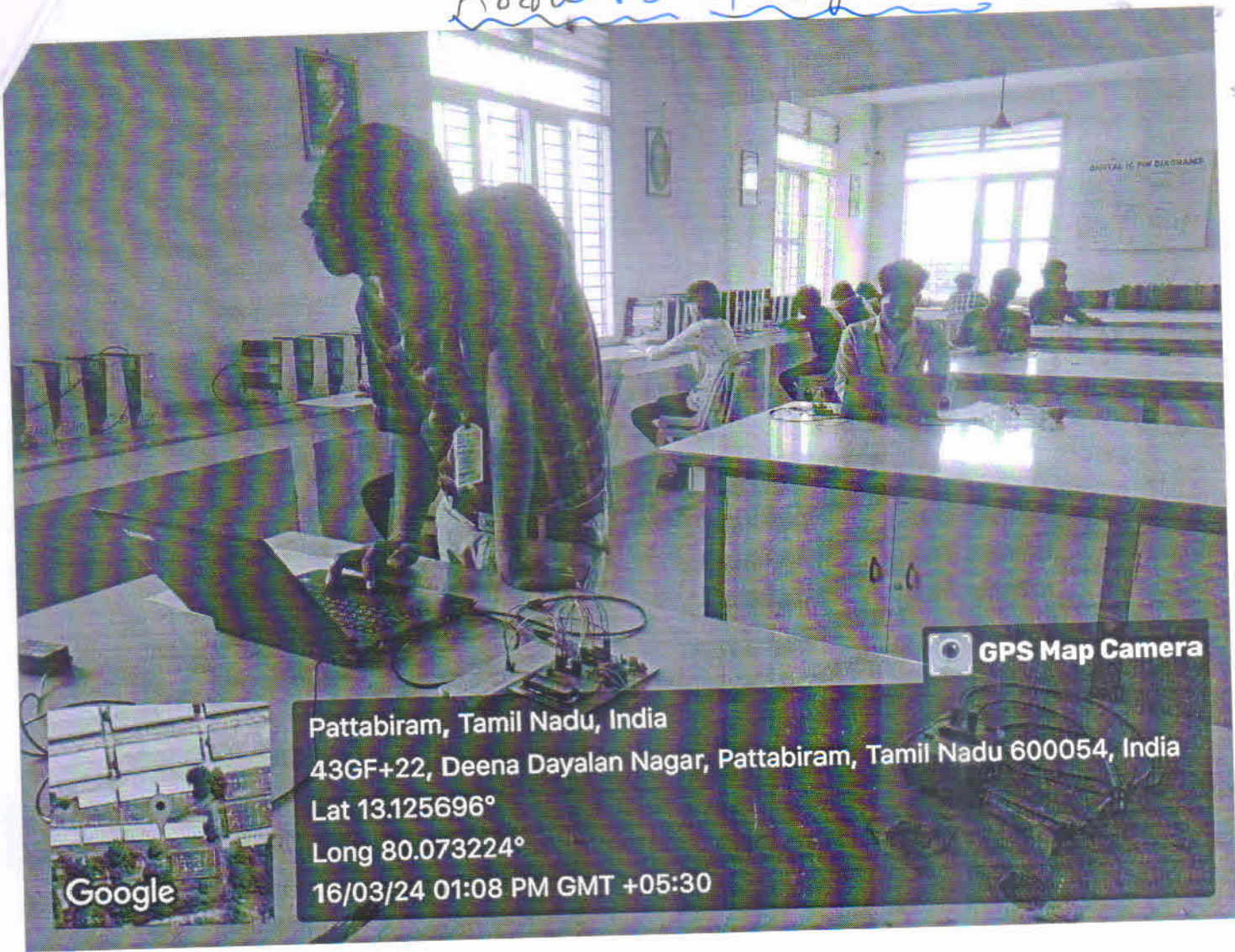

 **GPS Map Camera**

Pattabiram, Tamil Nadu, India
43GF+22, Deena Dayalan Nagar, Pattabiram, Tamil Nadu 600054, India
Lat 13.125696°
Long 80.073224°
16/03/24 01:08 PM GMT +05:30



Assistant Professor and Head
Department of Electronics and
Communication Science
DRBCCC Hindu College
Pattabiram, Chennai - 600 072.

PRINCIPAL,
DHARMAMURTHI RAO BAHADUR CALAVALA CUNNAM
CHETTY'S HINDU COLLEGE
DHARMAMURTHI SWAMYAR, PATTABIRAM,
CHENNAI - 600 072.





☰ Google Classroom



II B com
A
44 students

This classroom card has a light blue background with a coffee cup and a pie chart illustration. The text indicates the course is 'II B com' with section 'A' and 44 students.

III B. Com
C
41 students

This classroom card has a light blue background with a laptop and a smartphone illustration. The text indicates the course is 'III B. Com' with section 'C' and 41 students.

II M. Com
PG
22 students

This classroom card has a light blue background with a graduation cap illustration. The text indicates the course is 'II M. Com' with section 'PG' and 22 students.

Marketing
II B
71 students

This classroom card has a light blue background with a book and glasses illustration. The text indicates the course is 'Marketing' with section 'II B' and 71 students.



II M. Com



Narmadha P



Pavi Nagaraj



Prakash E



Prasad Jeeva



Ruby Ruby



Sandhiya Sandy



Shri lakshmi



Siranjeevi R



Siva M



T yokesh



Stream



Classwork



People





III.B.Com

A



Announce something to you...



Sivapriya S
Yesterday



Good Evening Students,
I have enclosed herewith UNIT 1
notes for your reference. Kindly go
through it.

Thank you..

 FM Unit 1.docx

Add class comment



Stream



Classwork



People





III.B.Com



Teachers



Sivapriya S

Students



Abinaya S



Amar Sheriff



Anbu Selvan



Archana Archana.P



Benzene



Bhuvana Raghu



Deepa



Stream



Classwork



People



Principals

PRINCIPAL,
DHARMAMURTHI RAO BAHADUR CALAVALA CUNNAN
CHETTY'S HINDU COLLEGE
DHARMAMURTHI NAGAR, PATTABIRAM,
CHENNAI - 600 072.

C. K. K. S.
Calavala Cunna Chetty's Hindu College (Shri 2)
Dharmamurthi Nagar,
Porichram, Chennai-60012



03/01/24 05:00 PM

Students Teaching Students Topic: I know why the caged bird sings by Maya Angelou

GPS Map Camera

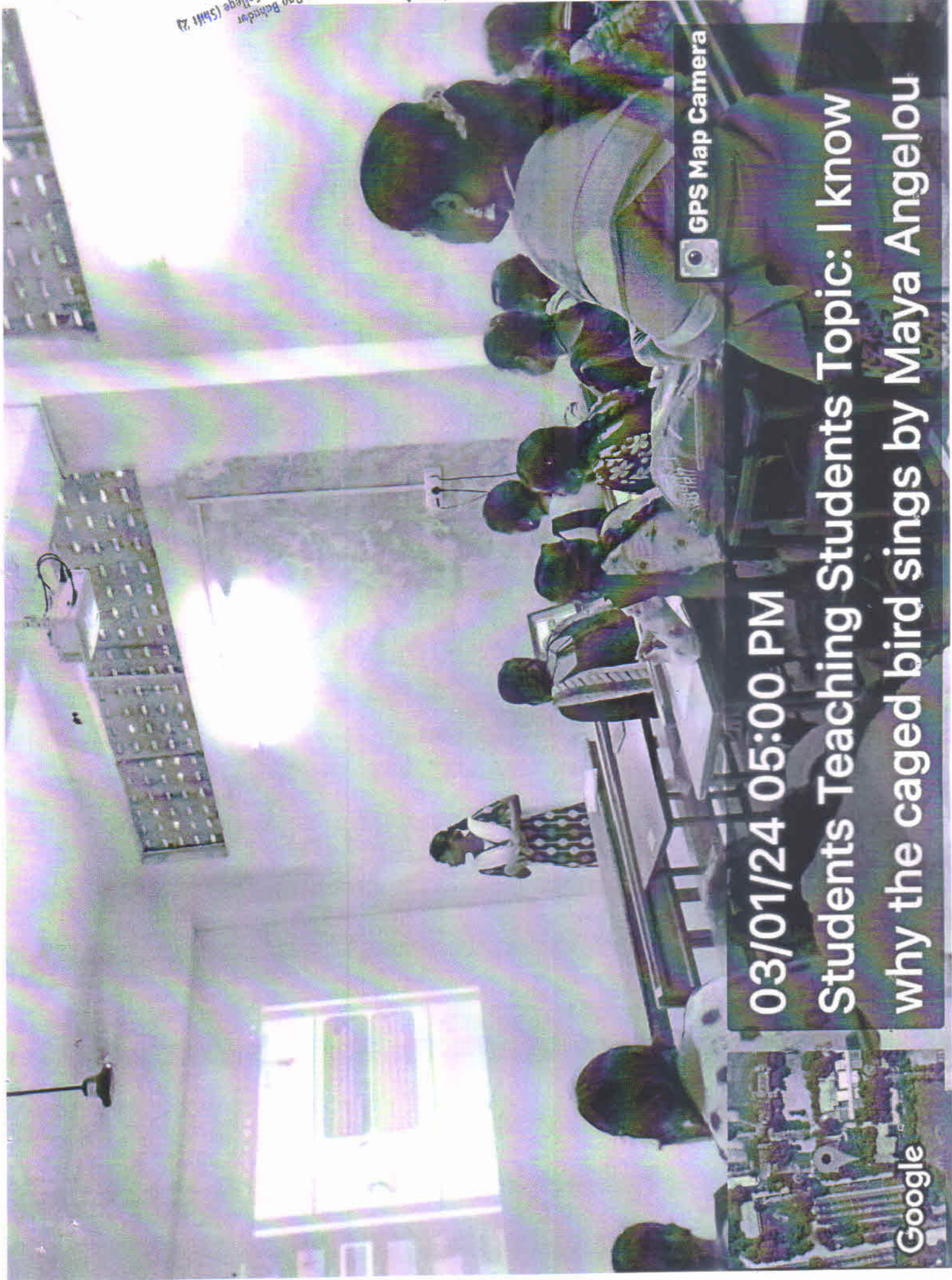

DRBCCC Hindu College
Department of English (Shift 2)
ICT Tools and e-content committee (General English)
MID-YEAR REPORT – AY 23-24

Keeping in mind the ever-widening integration of technology in language teaching, the Department of English (Shift 2) under the able guidance and supervision of Dr. Karpagavalli, Associate Professor and Head of the Department of English, started implementing ICT tools, and creating e-content for the General English students of the department from this academic year. The project which started on a trial basis soon picked up the necessary momentum. A meeting was conducted with the Head of the Department to evolve and finalize a plan for the ICT/e-content development. The Minutes of the Meeting is posted below.

Department of English (Shift 2)
Minutes of the Meeting
ICT Tools and e-content Committee

Date - July 17, 2023 / Venue – Department of English (Shift 2) / Time 11 am

A department level meeting was convened by the Head of the Department of English (Shift 2) Dr. C Karpagavalli on July 17, 2023, at 11 am. The primary objective of the meeting was to discuss the implementation of the ICT enabled teaching in the English classrooms and the creation of e-content for teaching and learning purposes.

The following were the attendees:

1. Dr. C Karpagavalli- Head of the Department of English (Shift 2)
2. Prof. Premjith Mathew - Assistant Professor, Department of English
3. Prof. K Karthi - Assistant Professor, Department of English
4. Prof. R Dinesh Kumar - Assistant Professor, Department of English

The meeting discussed the following points in connection to the ICT tools and e-content development:

- The attendees of the meeting opined that the teaching fraternity should move away from the comfort zone of using traditional methods of teaching and embrace technology to engage the learner. There is the need for a paradigm shift in mind set of the teachers. Teachers should be encouraged to use MALL (Mobile Assisted Language Learning) in the classroom.
- It was decided to conduct a survey/ poll among the first-year students of DRBCCC Hindu college to gauge their response regarding ICT / e-content.
- The members agreed to create an online e-content club in the college adding all the first-year students in a WhatsApp group.

C. Karthi
Associate Professor
Department of English
DRBCCC Hindu College (Shift 2)
Pattabirum, Chennai-600072

- The attendees opined that a proposal with the infrastructural needs of the department (extra computer with printer and scanner), projectors in the classroom, along with a detailed proposal for a language lab should be prepared based on the survey. The same should be submitted to the Principal and the Director.
- It was decided in the meeting to plan for a workshop on ICT Tools for the teachers in the second week of August. The objective of the workshop is to enable teachers to familiarize with the necessary IT and e-content generation skills.
- It is imperative that teachers prepare e-content for their respective classes and share it in the department WhatsApp group for documentation purpose. It was suggested that every teacher create at least one e-content for their students.
- It was also decided that an MoU can be signed with a company or an organization specializing in e-content/ digital tools.

The following duties and responsibilities were discussed and approved by the Head of the Department:

- Prof. Karthi will take care of the e-content generation in the BA English classes by creating an exclusive online group.
- Prof. Premjith will work to create a WhatsApp group for all the first-year students and will focus on content generation for Part II English.
- Prof. Dinesh, apart from Naan Mudhalvan project will offer his assistance to both B.A English and Part II English WhatsApp groups.

The meeting ended at 11. 30 am.

ACTIVITIES:

A WhatsApp group was created in the month of July 2023 to publish the e-content created by the staff and students. Most of the content created were related to the First Year general English syllabus. The common format used was digital posters. Assessment using Kahoot was also conducted through the WhatsApp group along with some in-app based quizzes and polls. Students who scored high marks were given cash awards and books as prizes. A WhatsApp group was also created for the second year General English students. (Science students) with the approval of the Head of the Department. Some of the e-content created (sample posters) can be accessed by scanning this QR code.



Sample report of the Kahoot Quizzes conducted for the students is given below:

Know Your State - The English Hub - Weekend Quiz			
Played on	26 Aug 2023		
Hosted by	Premjith7723		
Played with	100 players		
Played	10 of 10		
Overall Performance			
Total correct answers (%)	53.80%		
Total incorrect answers (%)	46.20%		
Average score (points)	4418.87 points		
Feedback			
Number of responses	0		
How fun was it? (out of 5)	0.00 out of 5		
Did you learn something?	0.00% Yes	0.00% No	
Do you recommend it?	0.00% Yes	0.00% No	
How do you feel?	<input checked="" type="radio"/> 0.00% Positive	<input checked="" type="radio"/> 0.00% Neutral	<input checked="" type="radio"/> 0.00% Negative

YouTube channel link:

Scan the QR code to access the sample videos.



Action plan of the ICT Tools and e-content committee (General English) for the even semester ICT and e-content

- To encourage more students to create content and share the content in social media.
- To encourage staff members to create content based on the syllabus.
- To add more multimedia based (audio/ video) content.
- To create a team of social media content creators for the department and college.

Report submitted by:

1. Prof. Premjith Mathew, Assistant Professor, Department of English *P*
2. Prof. Dinesh Kumar, Assistant Professor, Department of English *RO*

Noted by - Dr. Karpagavalli, Head of the Department of English (Shift 2).

Dr. C. Karj
15/12/2023
 Dharmasurathi Rao Babbar
 Calovela Ganesh Chetty's Hindu College (Shift 2)
 Perthambam, Chennai-600073

for a language lab should be prepared based on the survey. The same should be submitted to the Principal and the Director.

- It was decided in the meeting to plan for a workshop on ICT Tools for the teachers in the second week of August. The objective of the workshop is to enable teachers to familiarize with the necessary IT and e-content generation skills.
- It is imperative that teachers prepare e-content for their respective classes and share it in the department WhatsApp group for documentation purpose. It was suggested that every teacher create at least one e-content for their students.
- It was also decided that an MoU can be signed with a company or an organization specializing in e-content/ digital tools.

The following duties and responsibilities were discussed and approved by the Head of the Department:

- Prof. Karthi will take care of the e-content generation in the BA English classes by creating an exclusive online group.
- Prof. Premjith will work to create a WhatsApp group for all the first-year students and will focus on content generation for Part II English.
- Prof. Dinesh, apart from Naan Mudhalvan project will offer his assistance to both B.A English and Part II English WhatsApp groups.

The meeting ended at 11. 30 am.

ACTIVITIES:

A WhatsApp group was created in the month of July 2023 to publish the e-content created by the staff and students. Most of the content created were related to the First Year general English syllabus. The common format used was digital posters. Assessment using Kahoot was also conducted through the WhatsApp group along with some in-app based quizzes and polls. Students who scored high marks were given cash awards and books as prizes. A WhatsApp group was also created for the second year General English students. (Science students) with the approval of the Head of the Department. Some of the e-content created (sample posters) can be accessed by scanning this QR code.



C. Karthi
Dharmamurthi Rao Bahadur
Gandhi Commemorative Chetty's Hindu College (Shift 2)
Dharmamurthi Nagar,
Post: Narayanapuram, Chennai-600072

Sample report of the Kahoot Quizzes conducted for the students is given below:

Know Your State - The English Hub - Weekend Quiz			
Played on	26 Aug 2023		
Hosted by	Premjith7723		
Played with	100 players		
Played	10 of 10		
Overall Performance			
Total correct answers (%)	53.80%		
Total incorrect answers (%)	46.20%		
Average score (points)	4418.87 points		
Feedback			
Number of responses	0		
How fun was it? (out of 5)	0.00 out of 5		
Did you learn something?	0.00% Yes	0.00% No	
Do you recommend it?	0.00% Yes	0.00% No	
How do you feel?	<input checked="" type="radio"/> 0.00% Positive	<input checked="" type="radio"/> 0.00% Neutral	<input checked="" type="radio"/> 0.00% Negative

YouTube channel link:

Scan the QR code to access the sample videos.



Action plan of the ICT Tools and e-content committee (General English) for the next academic year

- To encourage more students to create content and share the content in social media.
- To encourage staff members to create content based on the syllabus.
- To add more multimedia based (audio/ video) content.
- To create a team of social media content creators for the department and college.

C. Jay
Dharmamurthi Rao Bahadur
Calsvrato Campus, Christy's Hindu College (Shift 2)
Dharmamurthi Nagar,
Perthambur, Chennai-600072

FEEDBACK FOR THE E-CONTENT ACTIVITY OF THE DEPARTMENT:

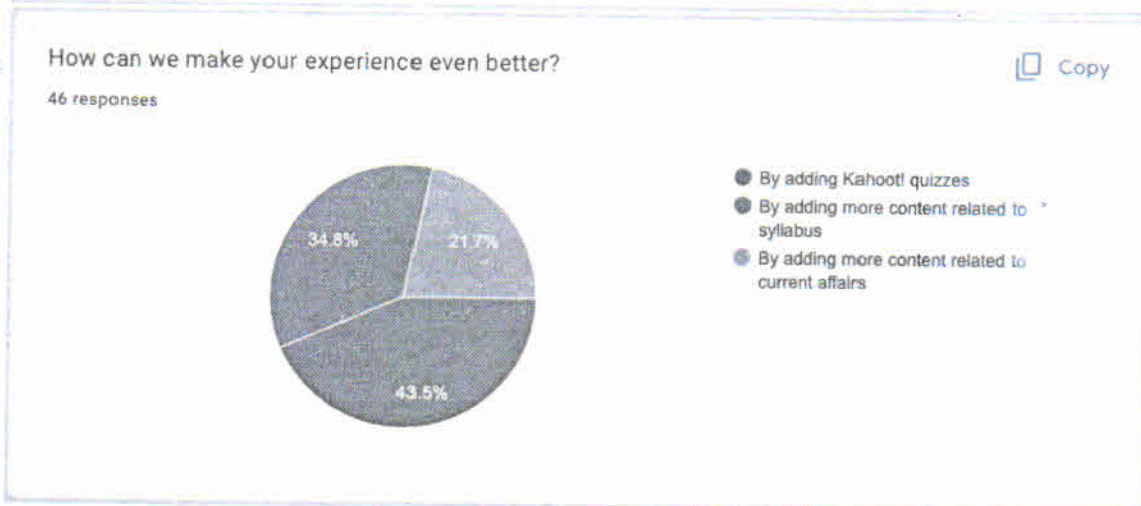
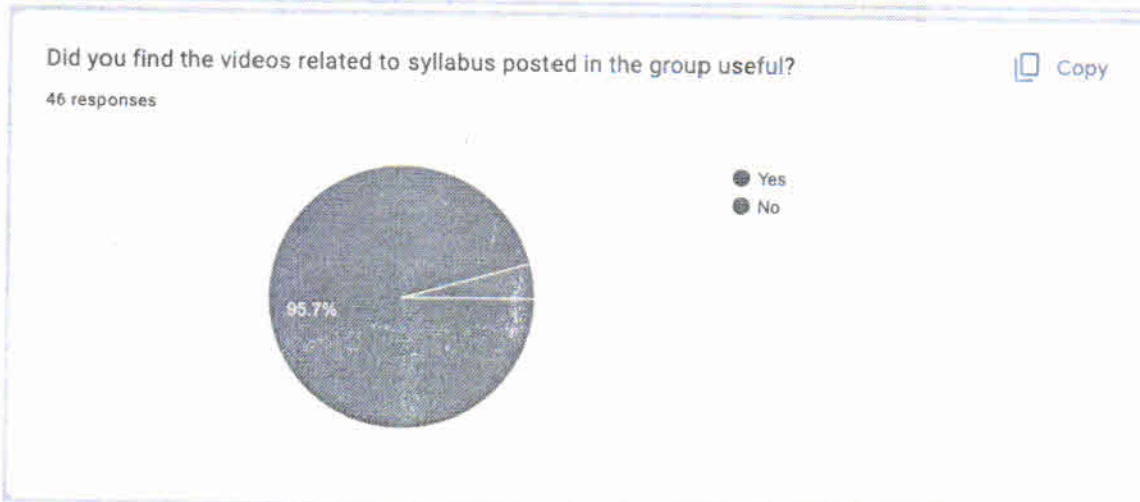
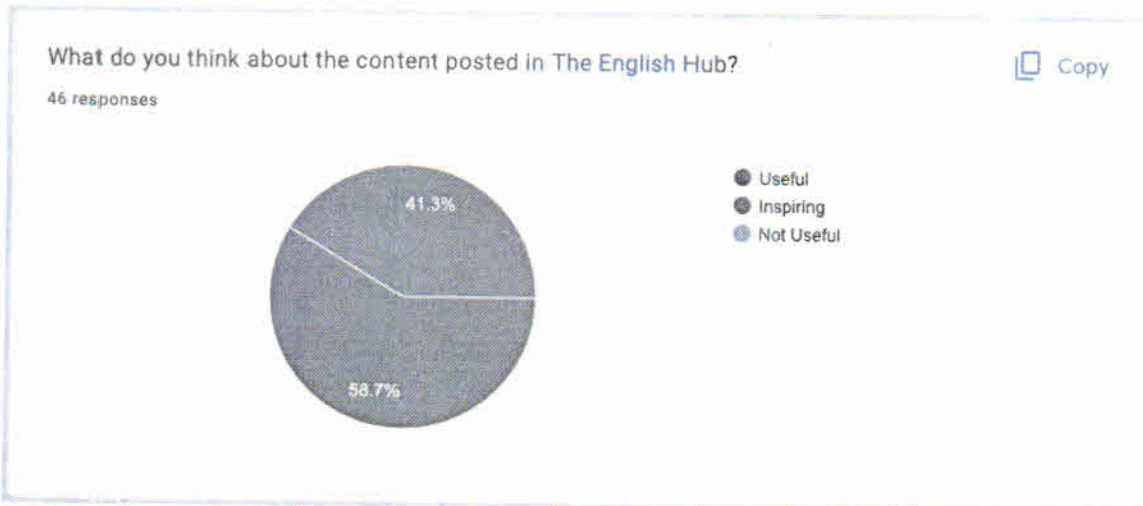

Report submitted by:

1. Prof. Premjith Mathew, Assistant Professor, Department of English
2. Prof. Dinesh Kumar, Assistant Professor, Department of English

Noted by - Dr. Karpagavalli, Head of the Department of English (Shift 2)

[Handwritten Signature]
Dr. Premjith Mathew
Department of English
Calevra College
Peruvottam, Chennai-600072

Department of Computer Science with Data Science

Varied Instructional Techniques

1. Live Demonstration using LCD projector
2. Power Point Presentation
3. Animated Videos
4. Web Bibliography
5. Whatapps
6. Google Forms
7. Google Class room
8. Spoken Tutorials – IIT Bombay
9. Swayam
10. NPTEL
11. Students Teaching Students
12. Peer Tutoring
13. www.w3schools.com
14. www.tutorialspoint.com

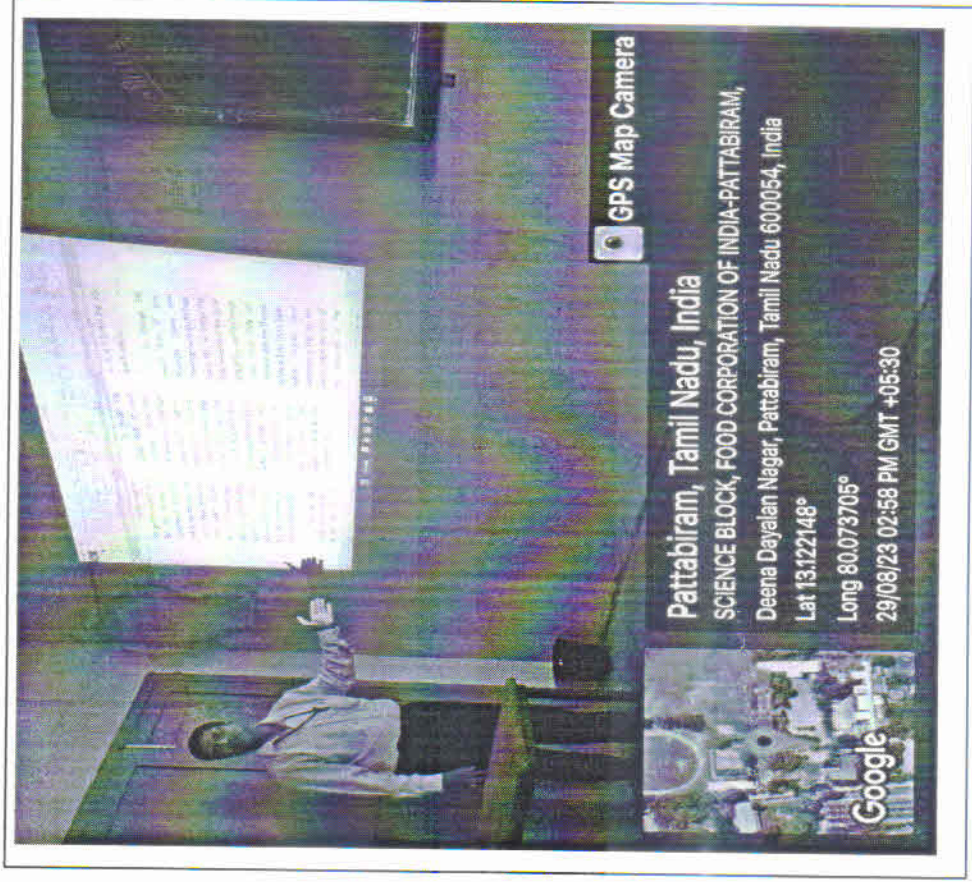

Dept. of Computer Science with Data Science

Google Class Room

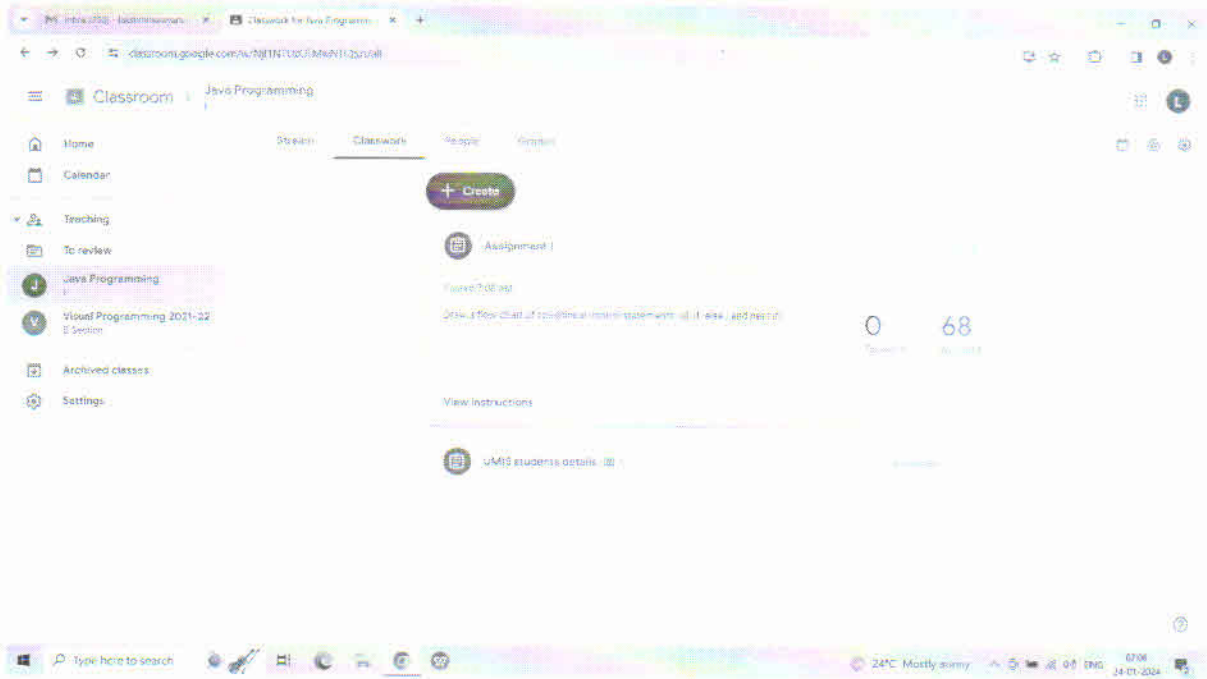

Dhille

HOD of CS with
DS

2.3.2

ICT Tool:

2.3.2

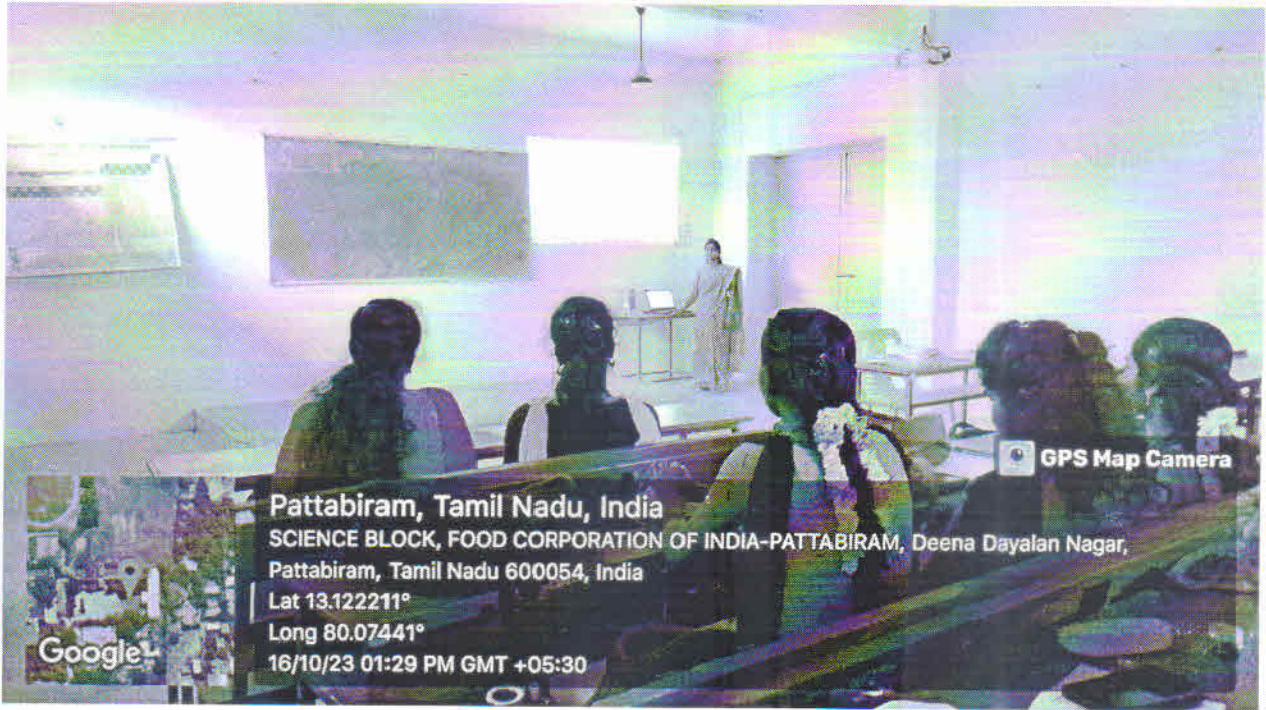

HEAD OF THE DEPARTMENT
Department of Chemistry
Dharmamurthi Rao Bahadur
Calavala Cunnan Chetty's Hindu College (Shift 2)
Dharmamurthi Nagar, Pattabiram, Chennai-72

PRINCIPAL,
DHARMAMURTHI RAO BAHADUR CALAVALA CUNNAN
CHETTY'S HINDU COLLEGE,
DHARMAMURTHI NAGAR, PATTABIRAM,
CHENNAI - 600 072.



**DHARMAMURTHI RAO BAHADUR CALAVALA CUNNAN CHETTY'S HINDU
COLLEGE**

PATTABIRAM, CHENNAI-600 072

DEPARTMENT OF COMPUTER APPLICATIONS



ICT TOOLS

2023-2024

ODD SEMESTER

C. Kalinraaj

**PRINCIPAL,
DHARMAMURTHI RAO BAHADUR CALAVALA
CUNNAN CHETTY'S HINDU COLLEGE,
DHARMAMURTHI NAGAR,
PATTABIRAM, CHENNAI - 600 072.**



REPORT ON ICT TOOLS

Information and Communication Technologies (ICT) have revolutionized the education landscape, and nowhere is this more evident than in colleges. From interactive learning platforms to cutting-edge research tools, ICT tools are transforming the way students learn, faculty teach, and institutions operate. This report explores the specific Information and Communication Technology (ICT) tools used for students focused on four key tools:

- Google Classroom
- Quizizz.com
- PowerPoint presentations
- WhatsApp

It will analyze their individual strengths and weaknesses, their impact on my learning, and potential areas for improvement.

1. Google Classroom:

- Strengths: Provides a centralized platform for course materials, assignments, and communication. Enables easy organization and access to resources.
- Weaknesses: Primarily text-based, limiting interactive and multimedia content.
- Impact on Learning: Google Classroom has streamlined my organization and access to course materials, facilitating better time management. It offers valuable insights on my progress and areas for improvement.
- Google Classroom link:- <https://classroom.google.com/c/NTIzMjE0?cjc=2lgifid>
- Reference book:-

Introduction To Computer Science Using Python – Charles Dierbach

<http://bedford-computing.co.uk/learning/wp-content/uploads/2015/10/Introduction-to-Computer-Science-Using-Python.pdf>

2. Quizizz.com:

- Strengths: Provides instant feedback and detailed performance analysis. Allows for personalized practice based on individual needs.
- Weaknesses: Limited scope for open-ended responses and critical thinking assessments.
- Impact on Learning: The personalized feedback loop helps me identify my strengths and weaknesses and target my studying effectively.
- Quizizz:- <https://quizizz.com/join>

3. PowerPoint Presentations:

- Strengths: Easy to create engaging presentations with multimedia elements. Effective for both individual and group projects.
- Weaknesses: Requires planning and creativity to avoid monotonous presentations.

- Impact on Learning: PowerPoint has enhanced my communication skills, ability to present information clearly and concisely, it has strengthened my critical thinking and organization skills during project development.
- Python Programming Unit 5 PPT Link:-
https://docs.google.com/presentation/d/1jAuu4EAI0X3KCvtKYezKnHOrNO2Ei682/edit?usp=drive_link&oid=106037122294220432878&rtpof=true&sd=true

4. WhatsApp:

- Strengths: Convenient and instant communication tool for connecting with classmates outside the classroom.
- Weaknesses: Can be distracting and disrupt focus if not used responsibly. Potential for misinformation and lack of formal structure compared to dedicated educational platforms.
- Impact on Learning: WhatsApp has fostered collaboration and peer-to-peer learning outside the classroom environment. It allows for quick inquiries and clarifications.
- WhatsApp Group Link:- <https://chat.whatsapp.com/DR5Hi2h6zs61zJQZ4T0dpr>

TOPIC:- INTRODUCTION TO PYTHON PROGRAMMING

PRESENTATION PHOTOS

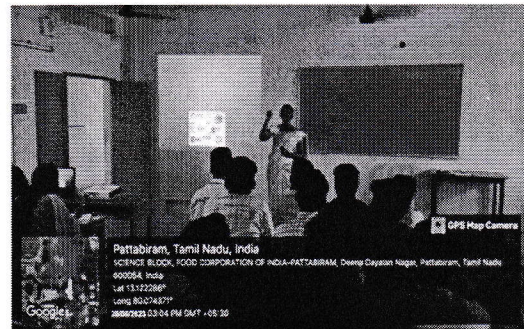
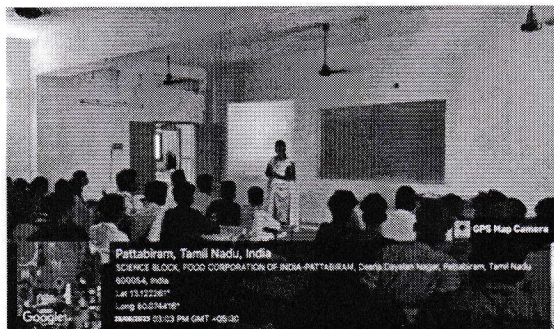
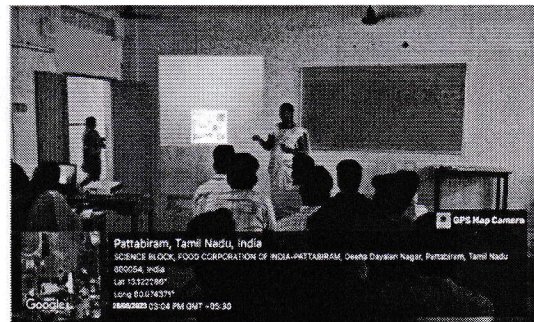
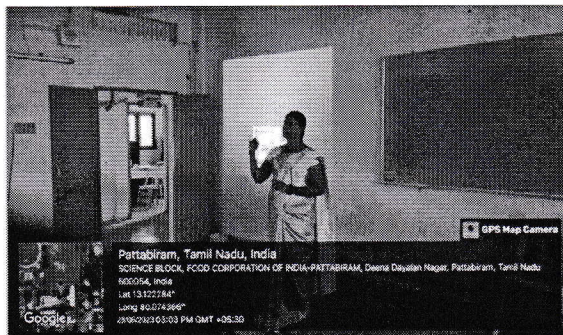

ICT TOOLS GOOGLE DRIVE LINK:

https://drive.google.com/drive/folders/1iWKOJ39N_-4Orj3Q3rt1-JCdaJaylPuQ?usp=drive_link

Conclusion:

The ICT tools mentioned above have become essential elements of my student toolbox, each serving a distinct purpose and impacting my learning differently. From streamlined organization and communication to gamified assessments and collaborative presentations, these tools enhance learning experience and make it more engaging and effective.

[Handwritten Signature]

CLASS INCHARGE

[Handwritten Signature]

HEAD OF THE DEPARTMENT

Dr. N. VENKATARAMANAN,
ME, M.Sc(Maths), M.Phil, PGDCA, B.Ed, Ph.D
Associate Professor & Head
Dept of Computer Applications
DRBCCC HINDU COLLEGE
Pattabiram, Chennai-600 072, TN, India.



[Handwritten Signature]
PRINCIPAL,
DHARMAMURTHI RAO BAHABUR CALAYALA
CUNNAN CHETTY'S HINDU COLLEGE,
DHARMAMURTHI NAGAR,
PATTABIRAM, CHENNAI - 600 072

**DHARMAMURTHI RAD BAHADUR CALAYALA CUNNAN CHETTY'S HINDU
COLLEGE**

PATTTABIRAM, CHENNAI-600 072

DEPARTMENT OF COMPUTER APPLICATIONS



PEER TUTORING

2023-2024

ODD SEMESTER



G. Velupillay
PRINCIPAL,
DHARMAMURTHI RAD BAHADUR CALAYALA
CUNNAN CHETTY'S HINDU COLLEGE,
PATTTABIRAM, CHENNAI-600 072

REPORT ON PEER TUTORING

Peer tutoring is a teaching and learning strategy in which students learn with and from each other without the immediate intervention of a teacher. Peer tutoring schemes frequently appeal to educators in Higher Education, and there is much literature examining implementation and assessment. Peer tutoring can help tutors develop communication skills, leadership skills, and a sense of personal satisfaction. This report is on peer teaching in a 1:5 student ratio, which is a form of small group learning that can be effective in promoting student engagement, active learning, and critical thinking.

The following topics were discussed during peer tutoring session.

1. Python Literals:

A literal in Python is a syntax that is used to completely express a fixed value of a specific data type. Literals are constants that are self-explanatory and don't need to be computed or evaluated.

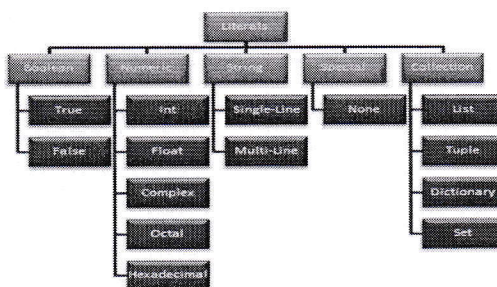

2. Exception Handling:

The try...except block is used to handle exceptions in Python. When an exception occurs, it is caught by the except block. The except block cannot be used without the try block. The finally block is always executed no matter whether there is an exception or not.

```
try:
    print(x)
except:
    print("Something went wrong")
finally:
    print("The 'try except' is finished")
```

3. Python Operators:

In Python programming, Operators in general are used to perform operations on values and variables. These are standard symbols used for the purpose of logical and arithmetic operations.

Peer Tutoring Approach

The interactive peer tutoring session was conducted with a 1:5 student ratio. The session was designed to be interactive and engaging, with peer tutors providing personalized attention and support to each student. The session was structured to help students understand concepts that they couldn't comprehend and provided the peer tutors with the revision of those topics.

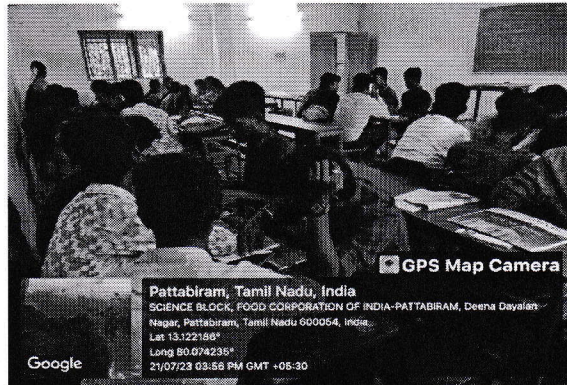
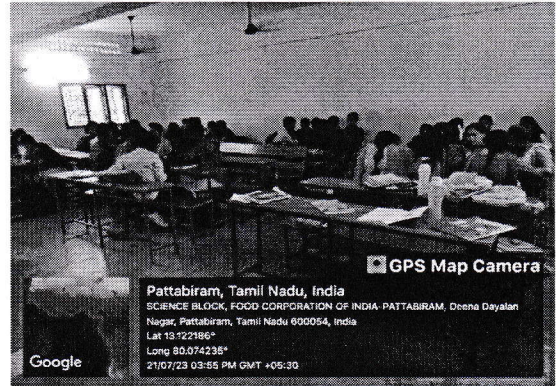
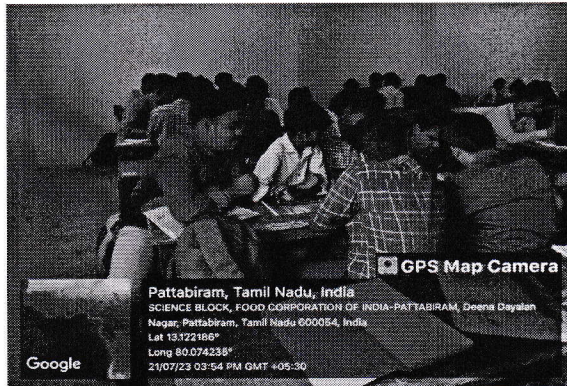

CONCLUSION

Overall, the interactive peer tutoring session was a positive experience for everyone involved. The 1:5 student ratios allowed for more personalized attention and support for each student, which was especially beneficial for students who may have difficulty understanding certain concepts. Additionally, the peer tutors themselves benefited from the experience by developing communication skills, leadership skills, and a sense of personal satisfaction.

[Signature]
CLASS INCHARGE



[Signature]
PRINCIPAL,
MAMMURTHI RAO BAHADUR CALAVALA
KUNNANI CHELTY'S HINDU COLLEGE,
DHARMAPURAM, CHENNAI

[Signature]
HEAD OF THE DEPARTMENT

Dr. N. VENKATARAMANAN,
ME, M.Sc(Maths), M.Phil, PGDCA, B.Ed, Ph.D
Associate Professor & Head
Dept of Computer Applications
DRBCC HINDU COLLEGE
Chennai-600 072 TN, India.

**DHARMAMURTHI RAO BAHADUR CALAYALA CUNNAN CHETTY'S HINDU
COLLEGE**

PATTABIRAM, CHENNAI-600 072

DEPARTMENT OF COMPUTER APPLICATIONS



PEER TEACHING

2023-2024

ODD SEMESTER



G. Kalinayagi
PRINCIPAL,
DHARMAMURTHI RAO BAHADUR CALAYALA
CUNNAN CHETTY'S HINDU COLLEGE,
PATTABIRAM, CHENNAI-600 072.

DHARMAMURTHI RAO BAHADUR CALAVALA
CUNNAN CHETTY'S HINDUCOLLEGE PATTABIRAM
CHENNAI - 72

DEPARTMENT OF COMPUTER APPLICATION

III BCA 'A'

PEER TO PEER TEACHING

RDBMS

S.NO	REG.NO	NAME	DETAILS	DATE
1	212100216	R.AJAY RATHAM	PEER TO PEER TEACHING	24.10.2023
2	212100219	S.ARJUN	PEER TO PEER TEACHING	29.10.2023
3	212100222	R.BALAJI	PEER TO PEER TEACHING	30.10.2023
4	212100230	A.V.CHINMAI SAGAR	PEER TO PEER TEACHING	04.11.2023
5	212100231	V.GOKUL RAJ	PEER TO PEER TEACHING	02.11.2023
6	212100255	S.GOKUL	PEER TO PEER TEACHING	03.11.2023
7	212100262	R.PRASHANT	PEER TO PEER TEACHING	07.11.2023
8	212100263	E.N.SAI KUMAR	PEER TO PEER TEACHING	05.11.2023
9	212100260	N.SANTHANA KRISHNA	PEER TO PEER TEACHING	06.11.2023
10	212100273	S.K.SHARATH KUMAAR	PEER TO PEER TEACHING	15.11.2023
11	212100276	R.VIGNESH	PEER TO PEER TEACHING	10.11.2023
12	212100288	V.VIJAY JOSHWA	PEER TO PEER TEACHING	11.11.2023
13	212100290	O.J.JASMINE	PEER TO PEER TEACHING	12.11.2023
14	212100308	M.KALAVANI	PEER TO PEER TEACHING	14.11.2023

Subject Incharge

R. SURESH

HOD

Dr. N. VENKATARAMAN,
ME, M.Sc(Maths), M.Phil, PGDCA, B.Ed, Ph.D
Associate Professor & Head
Dept of Computer Applications
DRBCC HINDU COLLEGE
Pattabiram, Chennai-600 072, TN, India.



N. Venkatarayan
PRINCIPAL,
DHARMAMURTHI RAO BAHADUR CALAVALA
CUNNAN CHETTY'S HINDU COLLEGE,
PATTABIRAM, CHENNAI - 600 072, TAMIL NADU, INDIA.

**DHARMAMURTHI RAO BAHADUR CALAVALA
CUNNAN CHETTY'S HINDU COLLEGE PATTABIRAM
CHENNAI - 72**

**DEPARTMENT OF COMPUTER APPLICATION
PEER TO PEER TEACHING - III BCA 'A'**

RDBMS

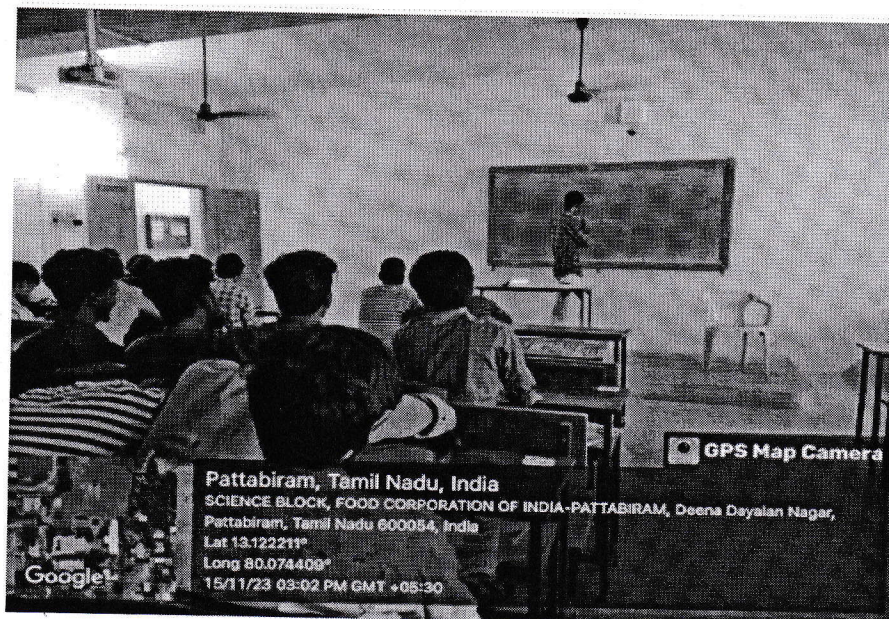
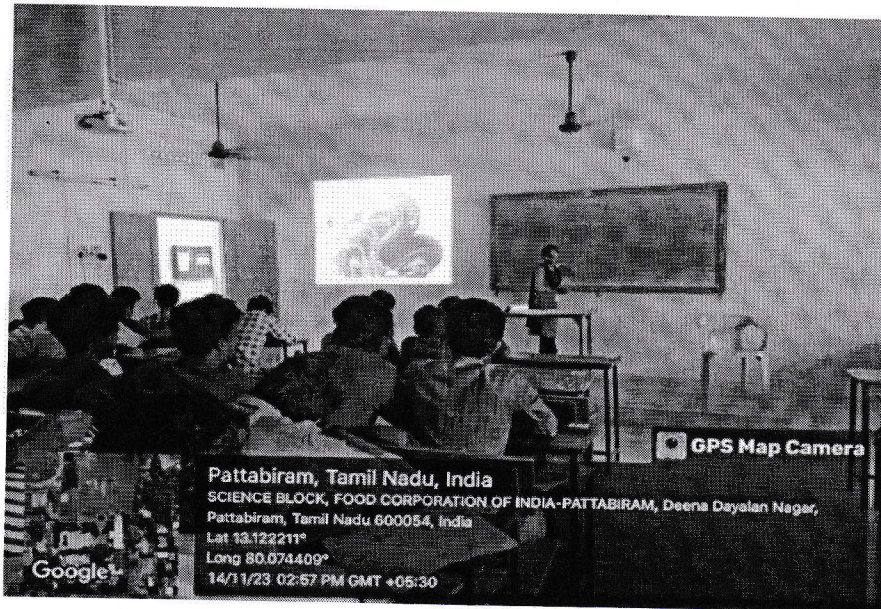

DHARMAMURTHI RAO BAHADUR CALAVALA
CUNNAN CHETTY'S HINDUCOLLEGE PATTABIRAM
CHENNAI – 72

DEPARTMENT OF COMPUTER APPLICATION

III BCA 'A'

PEER TO PEER TEACHING

MULTIMEDIA AND ITS APPLICATION

S.NO	REG.NO	NAME	DETAILS	DATE
1	212100216	R.AJAY RATHAM	PEER TO PEER TEACHING	26.10.2023
2	212100219	S.ARJUN	PEER TO PEER TEACHING	29.10.2023
3	212100222	R.BALAJI	PEER TO PEER TEACHING	30.10.2023
4	212100230	A.V.CHINMAI SAGAR	PEER TO PEER TEACHING	01.11.2023
5	212100231	V.GOKUL RAJ	PEER TO PEER TEACHING	02.11.2023
6	212100255	S.GOKUL	PEER TO PEER TEACHING	03.11.2023
7	212100262	R.PRASHANT	PEER TO PEER TEACHING	04.11.2023
8	212100263	E.N.SAI KUMAR	PEER TO PEER TEACHING	05.11.2023
9	212100260	N.SANTHANA KRISHNA	PEER TO PEER TEACHING	06.11.2023
10	212100273	S.K.SHARATH KUMAAR	PEER TO PEER TEACHING	07.11.2023
11	212100276	R.VIGNESH	PEER TO PEER TEACHING	10.11.2023
12	212100288	V.VIJAY JOSHWA	PEER TO PEER TEACHING	11.11.2023
13	212100290	O.J.JASMINE	PEER TO PEER TEACHING	12.11.2023
14	212100308	M.KALAVANI	PEER TO PEER TEACHING	14.11.2023

Subject Incharge

[JAYALAKSHMI]

HOD

Dr. N. VENKATARAMANAN,
ME, M.Sc(Maths), M.Phil, PGDCA, B.Ed, Ph.D
Associate Professor & Head
Dept of Computer Applications
DRBCCC HINDU COLLEGE
Pattabiram, Chennai-600 072, TN, India.

DHARMAMURTHI RAO BAHADUR CALAVALA
CUNNAN CHETTY'S HINDU COLLEGE PATTABIRAM
CHENNAI - 72

DEPARTMENT OF COMPUTER APPLICATION
PEER TO PEER TEACHING - III BCA 'A'

MULTIMEDIA AND ITS APPLICATION

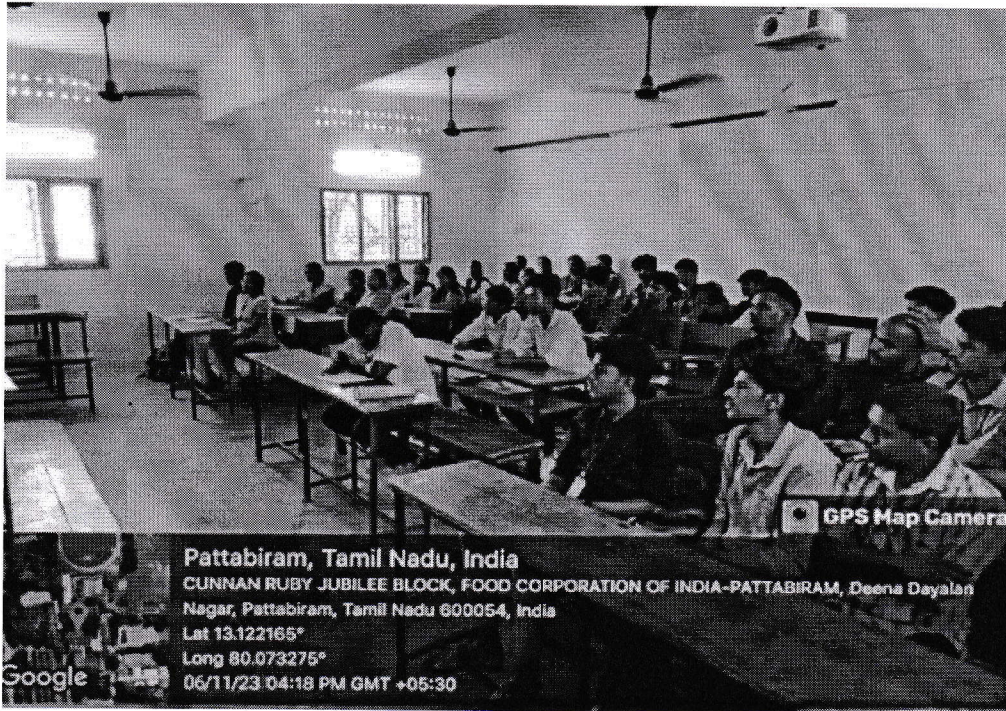

G. Mahalingam

PRINCIPAL,

DHARMAMURTHI RAO BAHADUR CALAVALA
CUNNAN CHETTY'S HINDU COLLEGE PATTABIRAM
CHENNAI – 72

DEPARTMENT OF COMPUTER APPLICATION

III BCA 'A'

PEER TO PEER TEACHING

SOFTWARE ENGINEERING

S.NO	REG.NO	NAME	DETAILS	DATE
1	212100216	R.AJAY RATHAM	PEER TO PEER TEACHING	22.10.2023
2	212100219	S.ARJUN	PEER TO PEER TEACHING	26.10.2023
3	212100222	R.BALAJI	PEER TO PEER TEACHING	29.10.2023
4	212100230	A.V.CHINMAI SAGAR	PEER TO PEER TEACHING	01.11.2023
5	212100231	V.GOKUL RAJ	PEER TO PEER TEACHING	02.11.2023
6	212100255	S.GOKUL	PEER TO PEER TEACHING	23.11.2023
7	212100262	R.PRASHANT	PEER TO PEER TEACHING	04.11.2023
8	212100263	E.N.SAI KUMAR	PEER TO PEER TEACHING	15.11.2023
9	212100260	N.SANTHANA KRISHNA	PEER TO PEER TEACHING	06.11.2023
10	212100273	S.K.SHARATH KUMAAR	PEER TO PEER TEACHING	07.11.2023
11	212100276	R.VIGNESH	PEER TO PEER TEACHING	10.11.2023
12	212100288	V.VIJAY JOSHWA	PEER TO PEER TEACHING	11.11.2023
13	212100290	O.J.JASMINE	PEER TO PEER TEACHING	12.11.2023
14	212100308	M.KALAVANI	PEER TO PEER TEACHING	14.11.2023

Subject Incharge

HOD

Dr. N. VENKATARAMAN,
ME, M.Sc(Maths), M.Phil, PGDCA, B.Ed, Ph.D
Associate Professor & Head
Dept of Computer Applications
DRBCC HINDU COLLEGE
Pattabiram, Chennai-600 072, TN, India.

DHARMAMURTHI RAO BAHADUR CALAVALA
CUNNAN CHETTY'S HINDU COLLEGE PATTABIRAM
CHENNAI - 72

DEPARTMENT OF COMPUTER APPLICATION
PEER TO PEER TEACHING - III BCA 'A'

SOFTWARE ENGINEERING

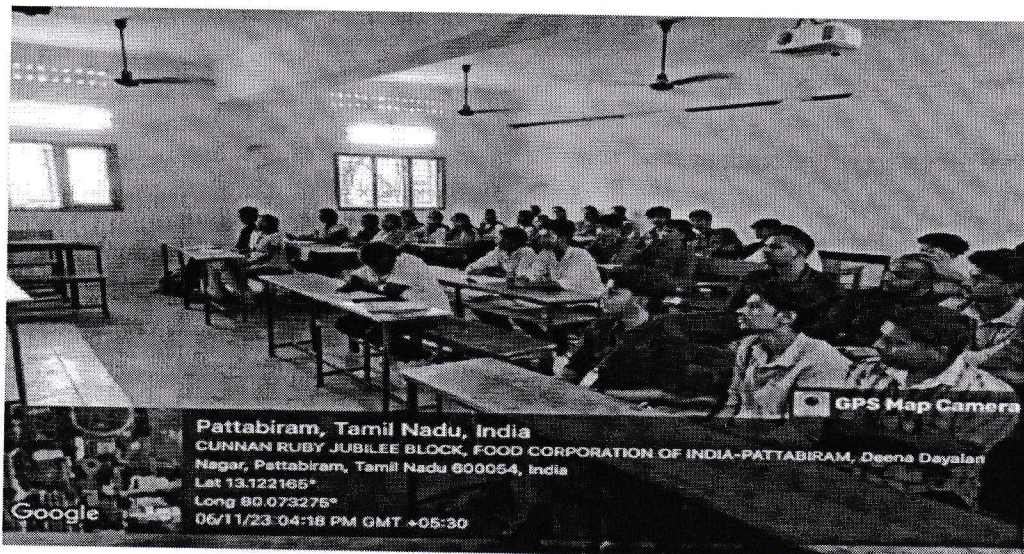
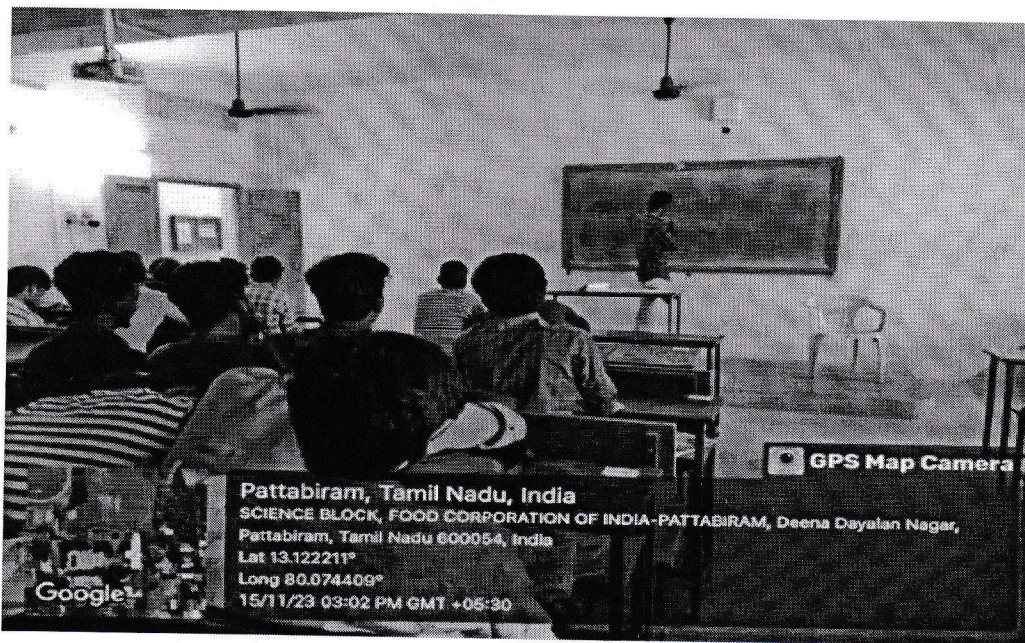

G. Kalinmaray
PRINCIPAL,
DHARMAMURTHI RAO BAHADUR CALAVALA
CUNNAN CHETTY'S HINDU COLLEGE,
DHARMAMURTHI NAGAR,
PATTABIRAM, CHENNAI - 600 072

DHARMAMURTHI RAO BAHADUR CALAVALA
CUNNAN CHETTY'S HINDUCOLLEGE PATTABIRAM
CHENNAI - 72

DEPARTMENT OF COMPUTER APPLICATION

III BCA 'A'

PEER TO PEER TEACHING

OPERATING SYSTEM

S.NO	REG.NO	NAME	DETAILS	DATE
1	212100216	R.AJAY RATHAM	PEER TO PEER TEACHING	26.10.2023
2	212100219	S.ARJUN	PEER TO PEER TEACHING	29.10.2023
3	212100222	R.BALAJI	PEER TO PEER TEACHING	30.10.2023
4	212100230	A.V.CHINMAI SAGAR	PEER TO PEER TEACHING	01.11.2023
5	212100231	V.GOKUL RAJ	PEER TO PEER TEACHING	02.11.2023
6	212100255	S.GOKUL	PEER TO PEER TEACHING	03.11.2023
7	212100262	R.PRASHANT	PEER TO PEER TEACHING	04.11.2023
8	212100263	E.N.SAI KUMAR	PEER TO PEER TEACHING	05.11.2023
9	212100260	N.SANTHANA KRISHNA	PEER TO PEER TEACHING	06.11.2023
10	212100273	S.K.SHARATH KUMAAR	PEER TO PEER TEACHING	07.11.2023
11	212100276	R.VIGNESH	PEER TO PEER TEACHING	10.11.2023
12	212100288	V.VIJAY JOSHWA	PEER TO PEER TEACHING	11.11.2023
13	212100290	O.J.JASMINE	PEER TO PEER TEACHING	12.11.2023
14	212100308	M.KALAVANI	PEER TO PEER TEACHING	14.11.2023

B. Gayathri
Subject Incharge

[B. GAYATHRI]

Nh
HOD

Dr. N. VENKATARAMAN,
ME, M.Sc(Maths), M.Phil, PGDCA, B.Ed, Ph.D
Associate Professor & Head
Dept of Computer Applications
DRBCC HINDU COLLEGE
Pattabiram, Chennai-600 072, TN, India.



G. Ushinray
PRINCIPAL,
DHARMAMURTHI RAO BAHADUR CALAVALA
CUNNAN CHETTY'S HINDU COLLEGE

DHARMAMURTHI RAO BAHADUR CALAVALA
CUNNAN CHETTY'S HINDU COLLEGE PATTABIRAM
CHENNAI - 72

DEPARTMENT OF COMPUTER APPLICATION
PEER TO PEER TEACHING - III BCA 'A'

OPERATING SYSTEM

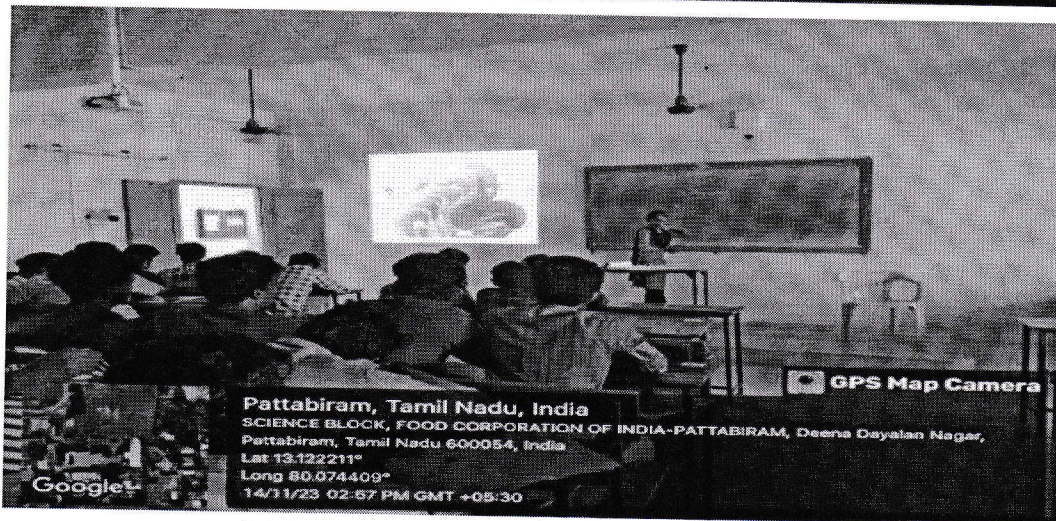
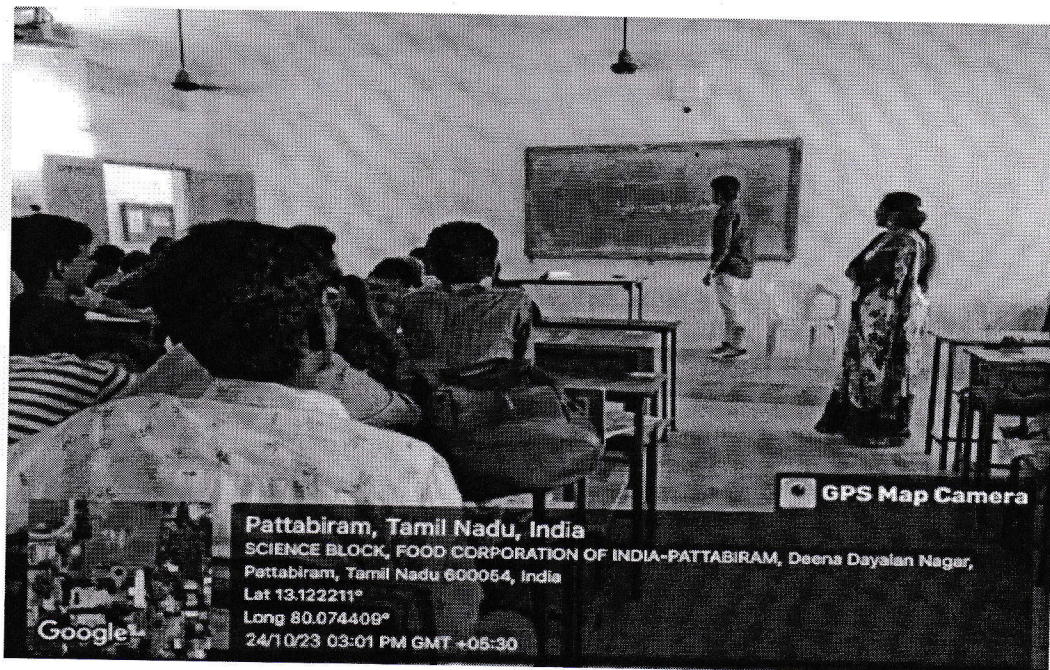

G. Kalinraaj
PRINCIPAL,
DHARMAMURTHI RAO BAHADUR CALAVALA
CUNNAN CHETTY'S HINDU COLLEGE,

**DHARMAMURTHI RAD BAHADUR CALAYALA CUNNAN CHETTY'S HINDU
COLLEGE**

PATTABIRAM, CHENNAI-600 072

DEPARTMENT OF COMPUTER APPLICATIONS



ICT TOOLS

ODD SEMESTER



G. Kalinayagi
PRINCIPAL,
DHARMAMURTHI RAD BAHADUR CALAYALA
CUNNAN CHETTY'S HINDU COLLEGE,
DHARMAMURTHI RAD BAHADUR
PATTABIRAM, CHENNAI - 600 072.

**DHARMAMURTHI RAO BAHADUR CALAYALA CUNNAN
CHETTY'S HINDU COLLEGE PATTABIRAM CHENNAI – 72**

DEPARTMENT OF COMPUTER APPLICATION

II BCAA

ICT TOOLS STUDENTS

STUDENT GROUP STUDY AND TEST

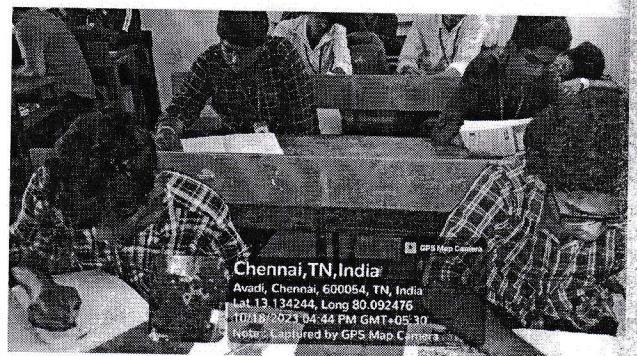
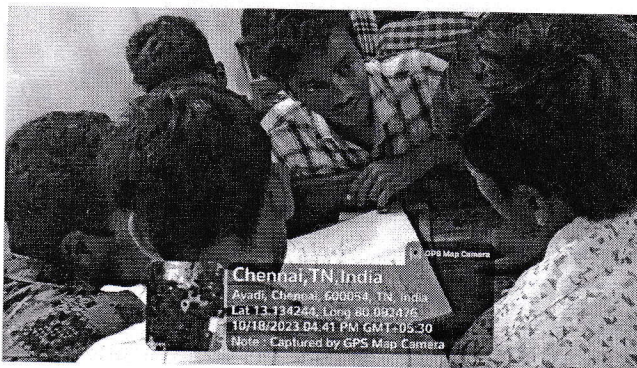

REFERENCE BOOKS : PROGRAMMING WITH JAVA
(E balagurusamy- 5th and 6th Edition)

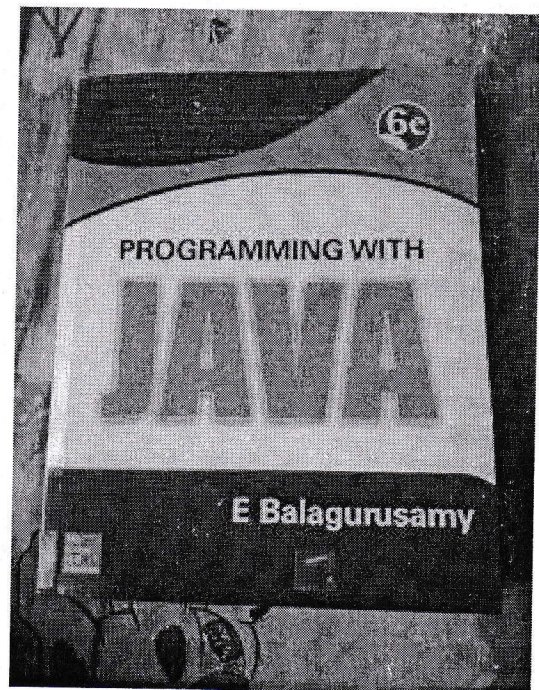
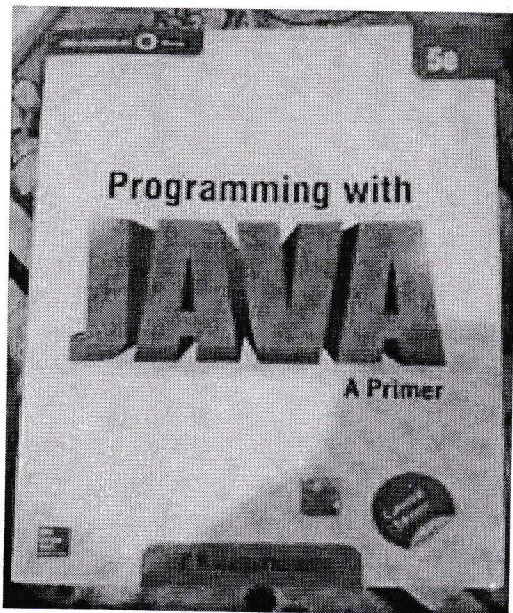

C. Calayalaya

**PRINCIPAL,
DHARMAMURTHI RAO BAHADUR CALAYALA**

GOOGLE CLASS :(group activity postgresql)

7:57 91%

|| BCA A 2022-2...

Add class comment

MR. PARTHU
Sep 30, 2023

SPOKEN TUTORIAL

1 attachment

Add class comment

New assignment: Group activity postgresql
Sep 27, 2023

Add class comment

New assignment: Assignment 2 : Explain ab...
Aug 3, 2023 (Edited Aug 9, 2023)

Add class comment

New assignment: Assignment1 : Explain diff...
Aug 3, 2023 (Edited Aug 9, 2023)

Add class comment

Stream Classwork People

7:56 91%

< Group activity postgresql

Aakash Aakash
Turned in

Aakash D group.pdf

Private comments

Deepa G Oct 11, 2023
good

Aakash Aakash Oct 11, 2023
Thank you mam

Add comment to Aakash Aakash

Return

7:55 92%

Deepa G

Students

Aakash Aakash

Aarthi Baskar

Anbarasu .c

Arivazhagi Jesteen

Arun Kumar

Bhavani .k

Stream Classwork People

VIDEO AND AUDIO NOTES

https://drive.google.com/file/d/1mcG-24uTt_DATM0vVW-8SEiwFeBixLJP/view?usp=sharing

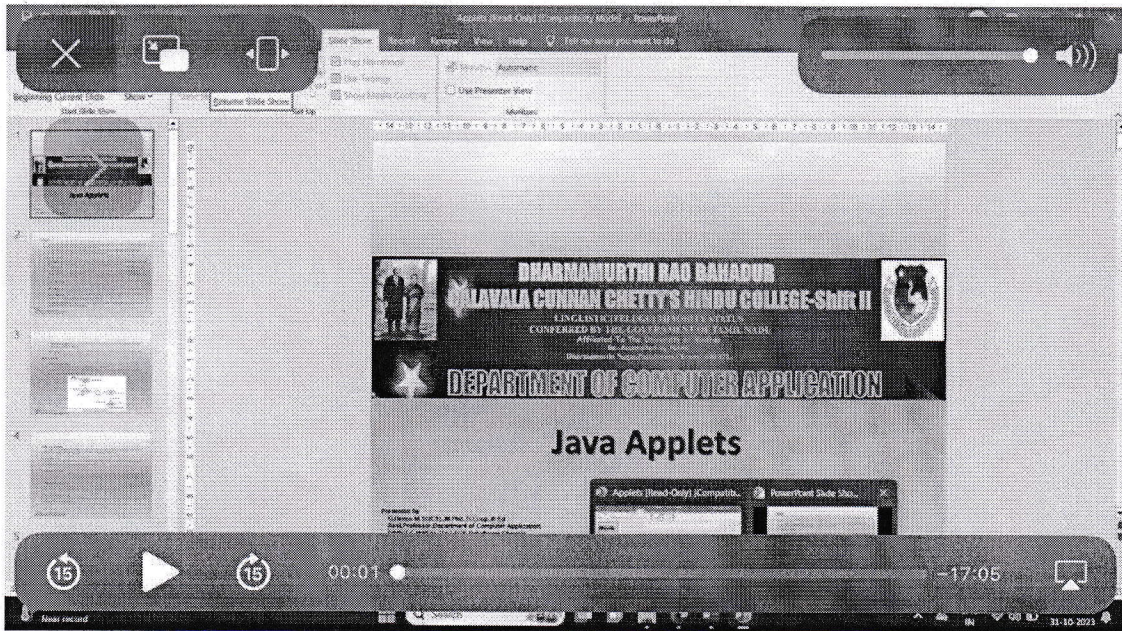

- **Client-Side Processing:** Applets offload some processing tasks from the web server to the client, potentially improving the server's performance and reducing network traffic.
- **Offline Usage:** Once an applet is downloaded, it can continue to run even when the user is not connected to the internet. This feature is useful for applications that require occasional or temporary disconnection from the web.

4.2 Life cycle of applet

1. Initialization (init() method):

The `init()` method is called when the applet is first loaded into the web browser. This method is typically used for one-time initialization tasks, such as setting up graphical components or initializing data. The `init()` method is executed only once during the applet's lifetime.

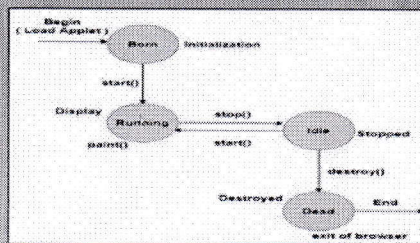

YOUTUBE LEARNING:

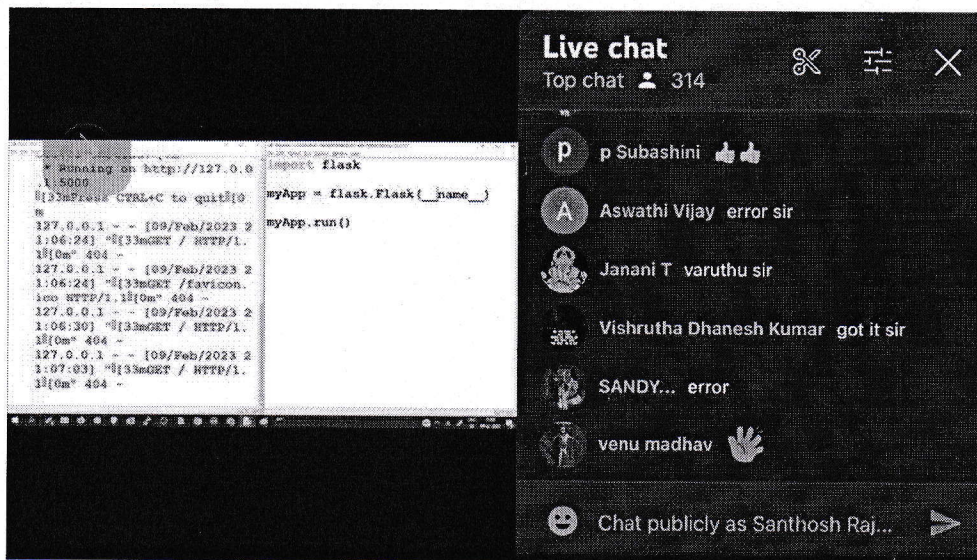
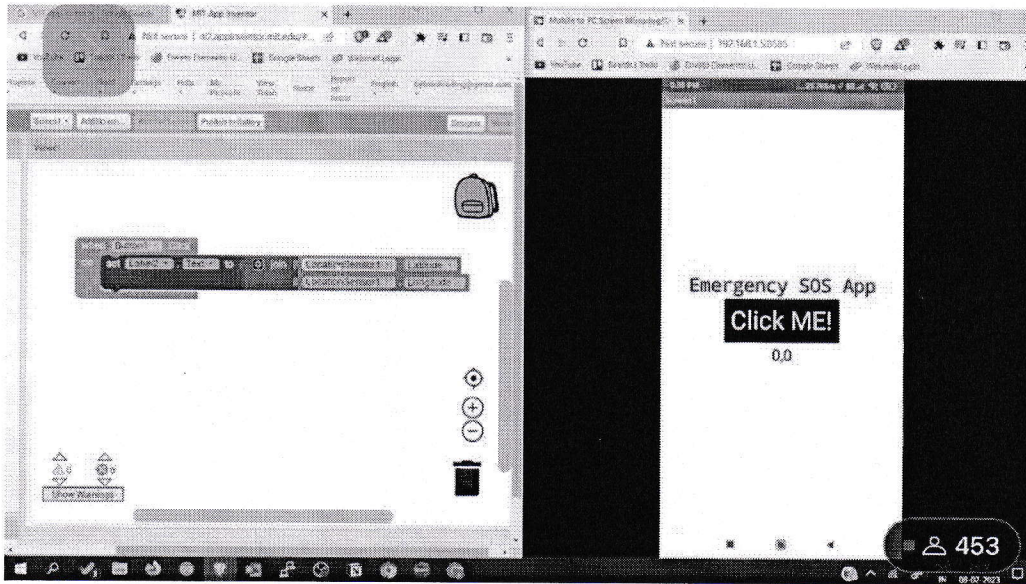

G. Srinivasan
PRINCIPAL,
DHARMAMURTHI RAO BAHADUR CALAYALA
CUNNAN CHETTY M. H. S. COLLEGE

**DHARMAMURTHI RAO BHADHUR CALAVALA CUNNAN CHETTY'S
HINDU COLLEGE PATTABIRAM CHENNAI – 72.**

**DEPARTMENT OF COMPUTER APPLICATION
II-BCA-'A'**

ICT TOOLS STUDENTS – COMPUTER ORGANISATION

STUDENT GROUP STUDY AND TEST

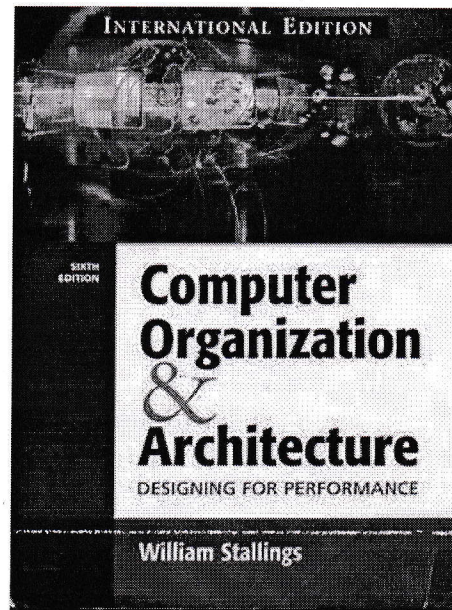
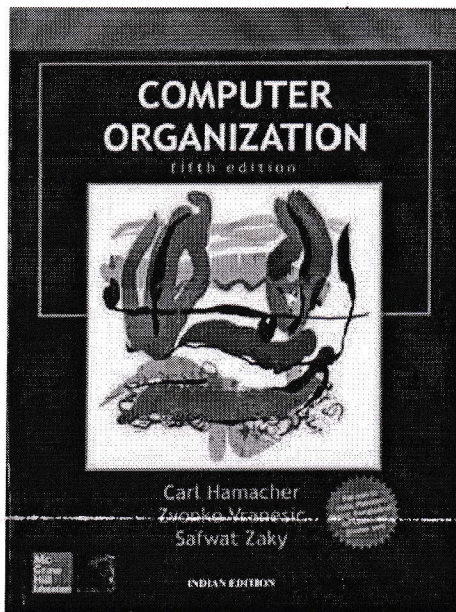
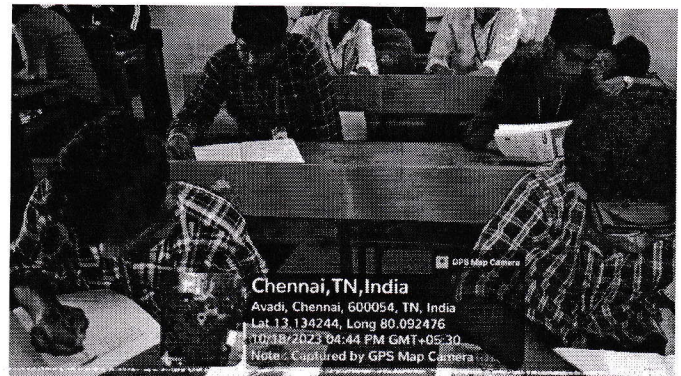
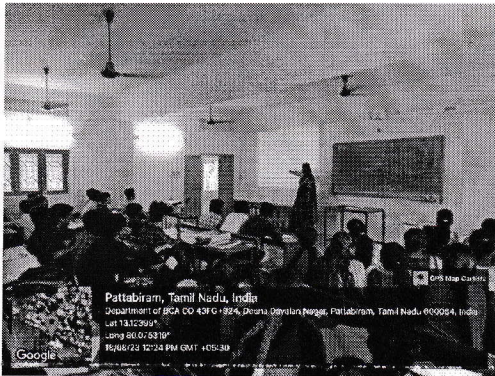

REFERENCE BOOKS:

1. Mathur- "Introduction to Microprocessor"- 3rd Edition- Tata McGraw-Hill-1993.
2. P. K. Ghosh and P. R. Sridhar- "0000 to 8085: Introduction to Microprocessors for Engineers and Scientists"- 2nd Edition- PHI- 1995.
3. NagoorKani- "Microprocessor (8085) and its Applications"- 2nd Edition- RBA Publications- 2006.
4. V. Vijayendran- "Fundamentals of Microprocessors – 8085"- S. Viswanathan Pvt. Ltd.- 2008.

YOUTUBE VIDEO:

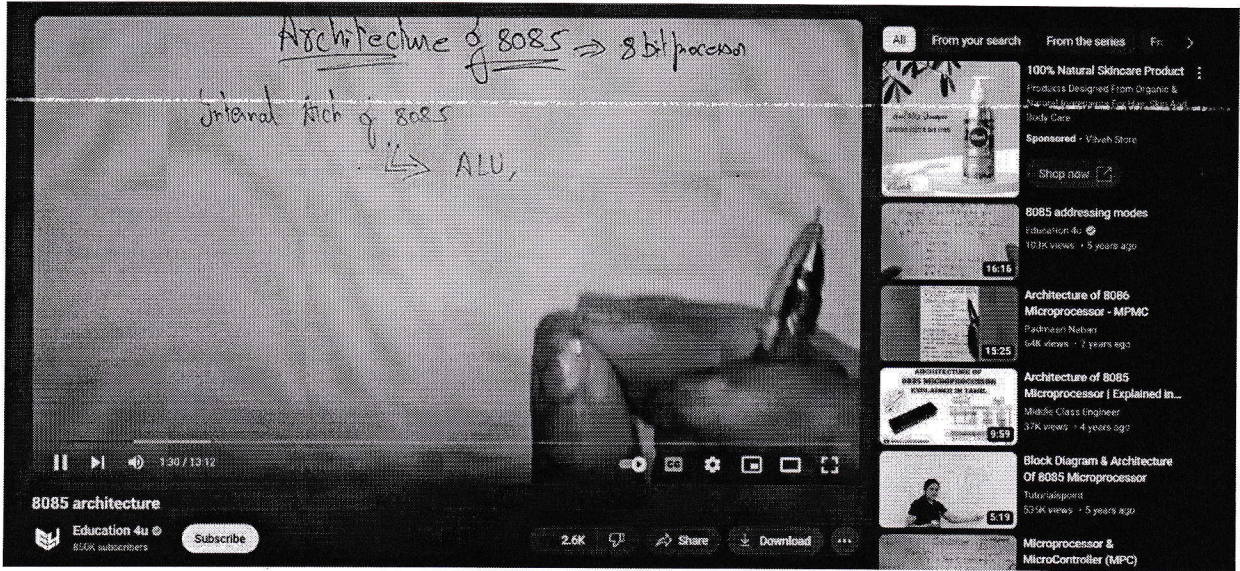

LINK:

<https://youtu.be/XEMyFUuV31o?si=mG90GxD4gueDt7fO>



C. Kalinraaj
PRINCIPAL,
DHARMAMURTHI RAO BAHADUR CALAVALA
CUNNAN CHETTY'S HINDU COLLEGE,
DHARMAMURTHI RAO BAHADUR,
PATTABIRAM, CHENNAI - 600 072.

**DHARMAMURTHI RAO BAHADUR CALAVALACUNNAN
CHETTY'SHINDUCOLLEGE PATTABIRAMCHENNAI-72**

DEPARTMENT OF COMPUTER APPLICATION II

BCA A

ICT TOOLS STUDENTS

STUDENT GROUP STUDY AND TEST :

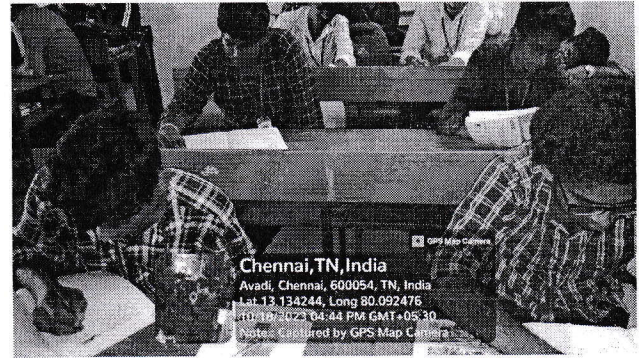
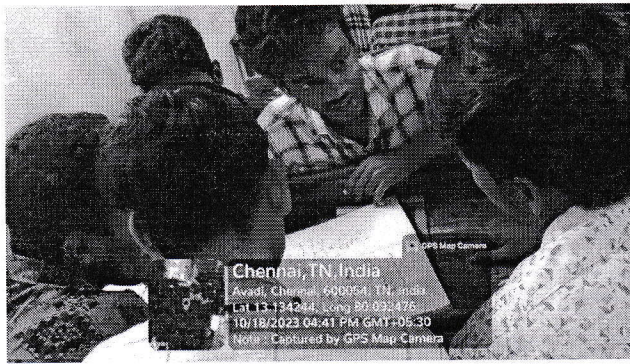

REFERENCE BOOKS: PROGRAMMING WITH DATA STRUCTURES ALGORITHM WITH
(Ebalagurusamy-5th and 6th Edition) JAVA PROGRAMMING

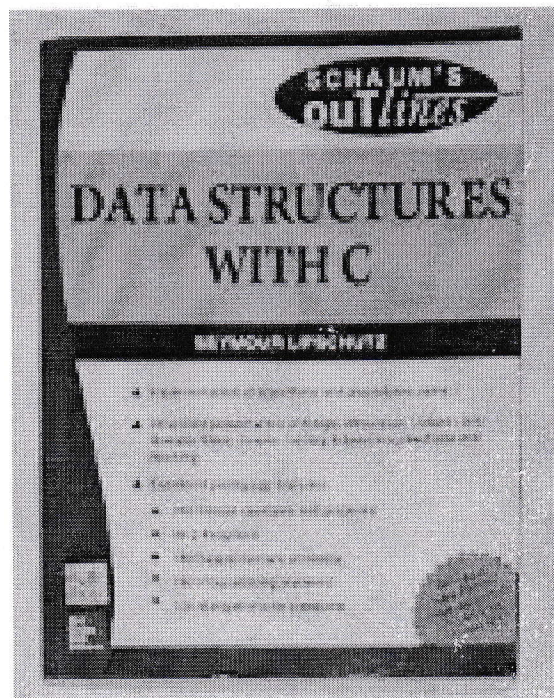

GOOGLE CLASS : (ASSIGNMENT SUBMISION)

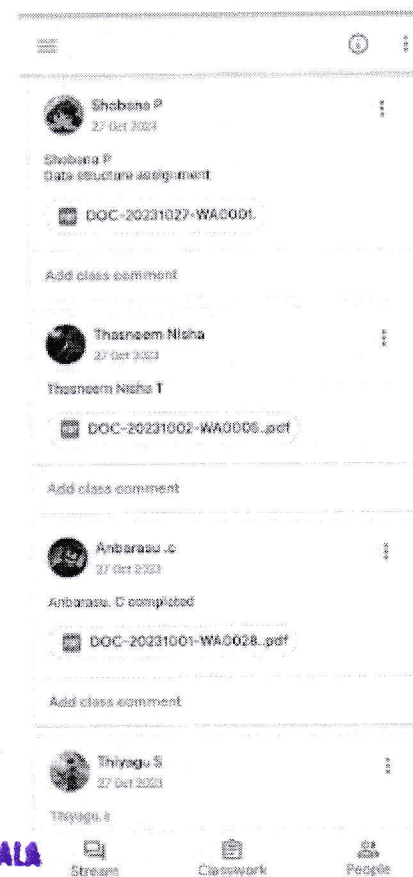
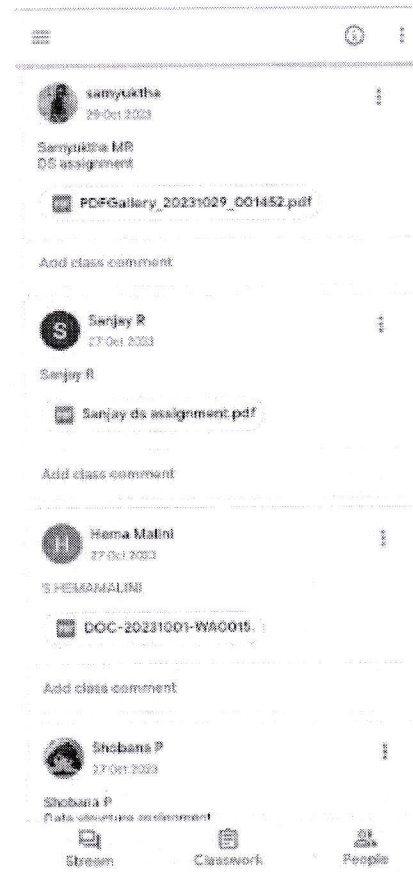
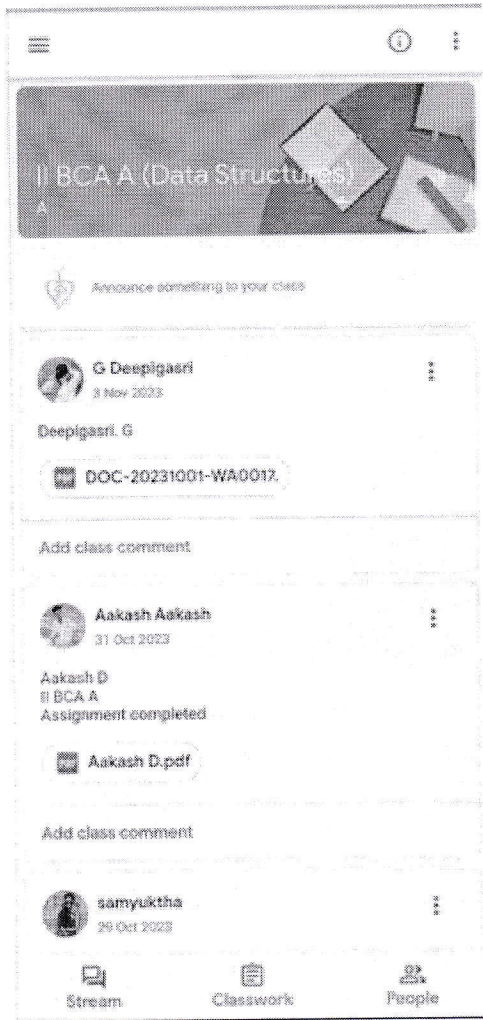

G. valinvaraj

PRINCIPAL,
DHARMAMURTHI RAO BAHADUR CALAYALA
CUNNAM CHETTY'S HINDU COLLEGE,
DHARMAMURTHI RAO BAHADUR
PATTABIRAM, CHENNAI - 600 072

**DHARMAMURTHI RAO BAHADUR CALAYALA CUNNAN CHETTY'S HINDU
COLLEGE**

PATTABIRAM, CHENNAI-600 072

DEPARTMENT OF COMPUTER APPLICATIONS



ICT TOOLS

ODD SEMESTER



G. valimuraj
PRINCIPAL,
DHARMAMURTHI RAO BAHADUR CALAYALA
CUNNAN CHETTY'S HINDU COLLEGE,
DHARMAMURTHI NAGAR,
PATTABIRAM, CHENNAI - 600 072.

DHARMAMURTHI RAO BAHADUR CALAVALA CUNNAN CHETTY'S

HINDU COLLEGE PATTABIRAM CHENNAI – 72

DEPARTMENT OF COMPUTER APPLICATION

II BCA B

ICT TOOLS STUDENTS

REFERENCE :

TEXT BOOKS:

1. E. Balagurusamy, "Programming with Java", TataMc-Graw Hill, 5th Edition.
2. Sagayaraj, Denis, Karthick and Gajalakshmi, "Java Programming for Core and advanced learners", Universities Press (INDIA) Private Limited 2018.

REFERENCES:

1. Herbert Schildt, "The complete reference Java", TataMc-Graw Hill, 7th Edition.

WEB REFERENCES:

- NPTEL & MOOC courses titled Java
- <https://nptel.ac.in/courses/106105191/>



S. Calinvaraj
PRINCIPAL,
DHARMAMURTHI RAO BAHADUR CALAVALA
CUNNAN CHETTY'S HINDU COLLEGE,
DHARMAMURTHI NAGAR,
PATTABIRAM, CHENNAI - 600 072.

DHARMAMURTHIRAOBHADHURCALAVALACUNNANCHETTY'SHINDU COLLEGE PATTABIRAM CHENNAI – 72.

DEPARTMENT OF COMPUTER APPLICATION

II-BCA-'B'

ICT TOOLS STUDENTS – PROGRAMMING IN JAVA

STUDENT GROUP STUDY AND TEST

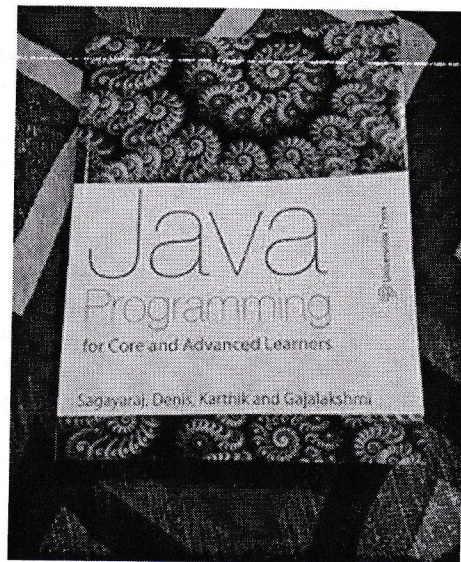
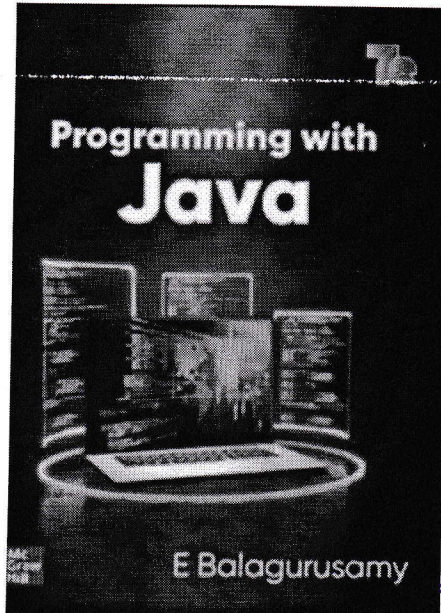
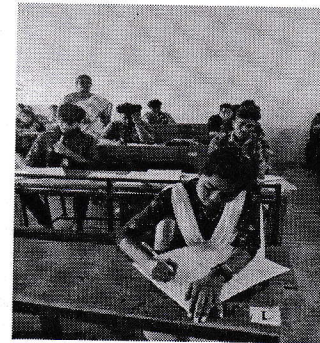
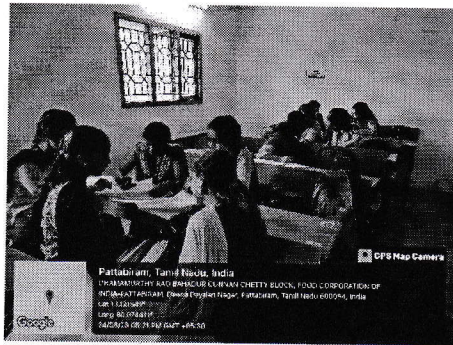

TEXT BOOKS:

1. E. Balagurusamy, "Programming in Java", TataMc_Graw Hill, 5th Edition.
2. Sagayaraj, Denis, Karthick and Gajalakshmi, "Java Programming for Core and advanced learners", Universities Press (INDIA) Private Limited 2018.

REFERENCES:

1. Herbert Schildt, "The complete reference Java", TataMc-Graw Hill, 7 th Edition.

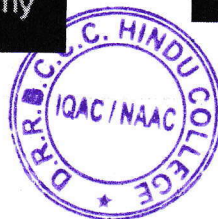

G. Calayala
PRINCIPAL,
DHARMAMURTHI RAO BAHADUR CALAYALA
CUNNAN CHETTY'S HINDU COLLEGE,
PATTABIRAM, CHENNAI - 600 072.

GOOGLE CLASSROOM:

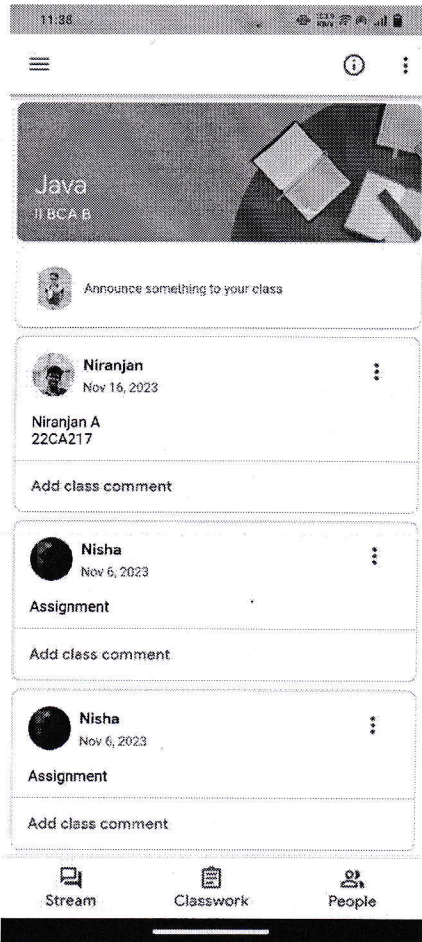

YOUTUBEVIDEO:

Java - Types of Inheritance

<p>Single Inheritance</p> <pre> graph BT B[Class B] --> A[Class A] </pre>	<pre> public class A{ } public class B extends A{ } </pre>
<p>Multi Level Inheritance</p> <pre> graph BT C[Class C] --> B[Class B] B --> A[Class A] </pre>	<pre> public class A { } public class B extends A { } public class C extends B { } </pre>
<p>Hierarchical Inheritance</p> <pre> graph TD A[Class A] --> B[Class B] A --> C[Class C] </pre>	<pre> public class A { } public class B extends A { } public class C extends B { } </pre>
<p>Multiple Inheritance</p> <pre> graph TD A[Class A] --> C[Class C] B[Class B] --> C </pre>	<pre> public class A { } public class B { } public class C extends A,B { } </pre> <p><small>// Java does not support multiple inheritance</small></p>
<p>Example</p> <pre> public class Person, Teacher{ </pre>	

LINK:

<https://youtu.be/XEMyFUuV31o?si=mG90GxD4gueDt7f0>



Kalimnagar

PRINCIPAL,
THE NDD BANADUR CALAYALA
HETTY'S HINDU COLLEGE,
MADHURAI NAGAR,
AM, SELINGAI - 600 072.

**DHARMAMURTHIRAOBHADHURCALAVALACUNNANCHETTY'SHIN
DU COLLEGE PATTABIRAM CHENNAI – 72.**

DEPARTMENT OF COMPUTER APPLICATION

II-BCA-'B'

ICT TOOLS STUDENTS – DATA STRUCTURES

STUDENT GROUP STUDY AND TEST

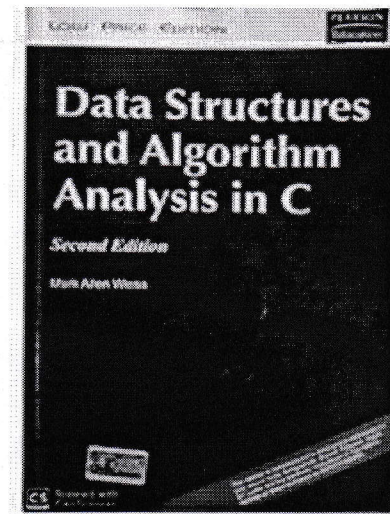
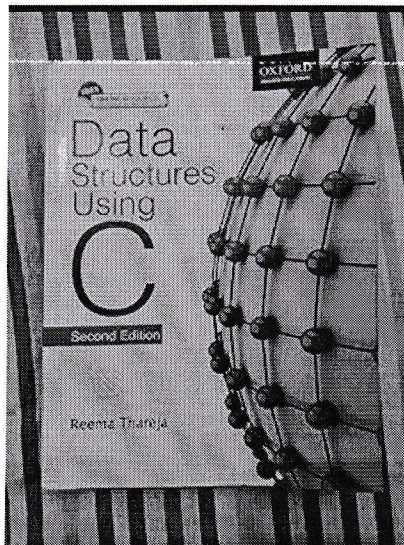
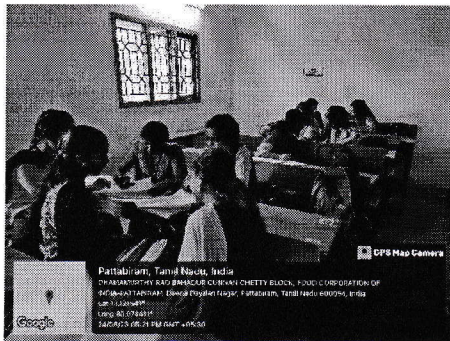

TEXT BOOKS:

1. Mark Allen Weiss, "Data Structures and Algorithm Analysis in C++", Pearson Education 2014, 4th Edition.
2. Reema Thareja, "Data Structures Using C", Oxford Universities Press 2014, 2nd Edition.

REFERENCES:

1. Thomas H. Cormen, Charles E. Leiserson, Ronald L. Rivest, Clifford Stein, "Introduction to Algorithms", McGraw Hill 2009, 3rd Edition.
2. Aho, Hopcroft and Ullman, "Data Structures and Algorithms", Pearson Education 2003..

GOOGLE CLASSROOM:

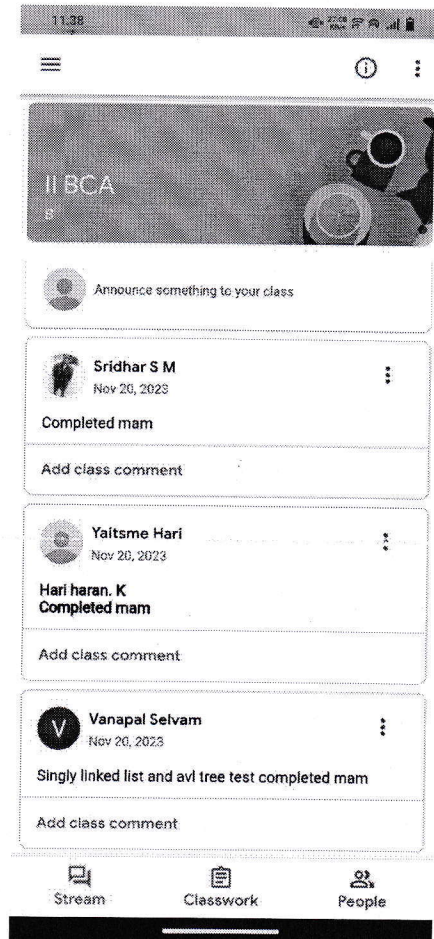
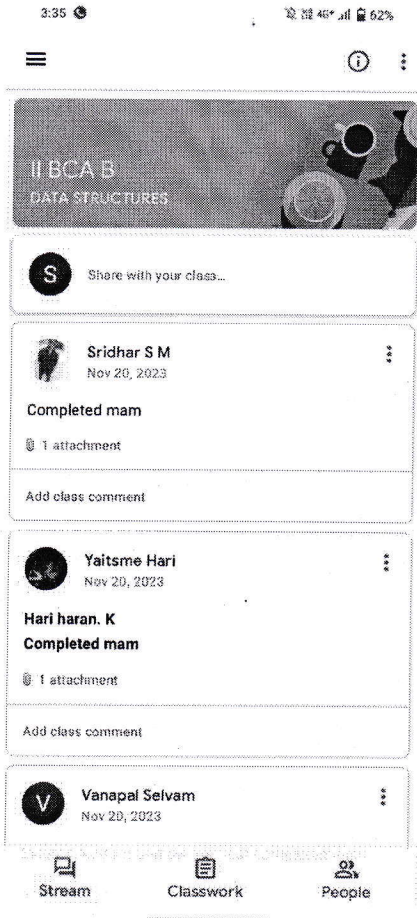

YOUTUBEVIDEO:

LINK:

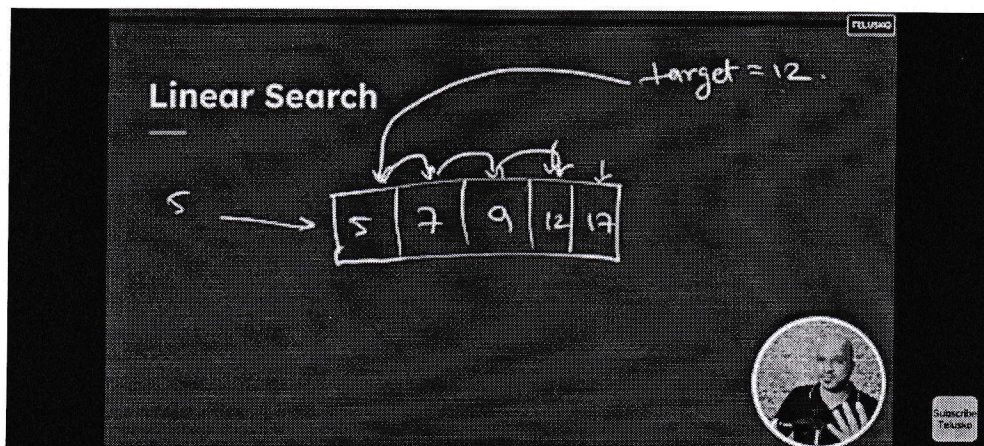

<https://youtu.be/xWLxhF3b5P8?si=CipbXrJRLqpgjie7>



G. Calin...
PRINCIPAL,
DHARMAMURTHI RAO RAHADUR CALAVALA
CUNNAN CHETTY'S HINDI COLLEGE,
DHARMAMURTHI HAGAR,
... 072.

**DHARMAMURTHI RAO BAHADUR CALAVALACUNNAN
CHETTY'SHINDUCOLLEGE PATTABIRAMCHENNAI-72**

DEPARTMENT OF COMPUTER APPLICATION II

BCA B

ICT TOOLS STUDENTS

STUDENT GROUP STUDY AND TEST :

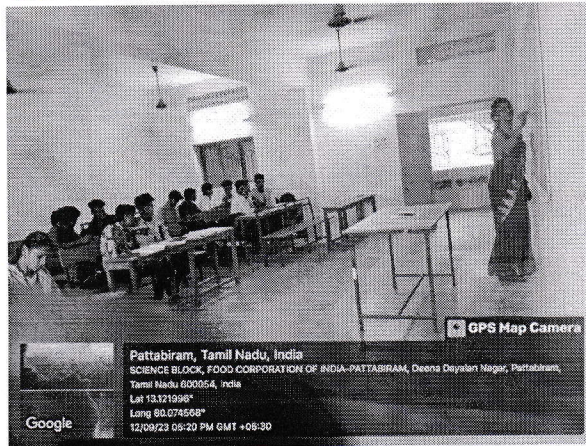

REFERENCE BOOKS: PROGRAMMING WITH COMPUTER ORGANIZATION

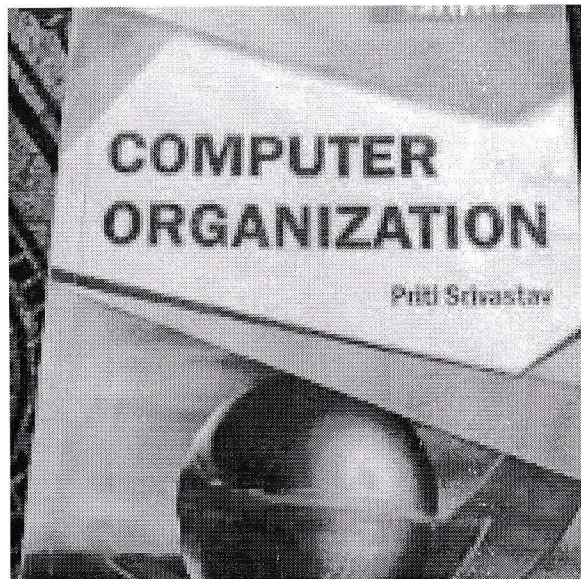

GOOGLE CLASS : (ASSIGNMENT SUBMISSION)

Pipeline Processing:

pipelining.png

8257_architecture.jpg

Add class comment

JANSI PAUL
26 Oct 2023

Students, post your assignments on or before 28/10/23

1. Pipeline Diagram,
2. DMA Controller diagram (only diagram).
3. Instruction set- Answer in details

1 class comment

Stream Classwork People

Pin-Diagram-of-8257-1.jpg

Add class comment

Monika Thirunavukarasu
28 Oct 2023

Pipeline

pipelining-1.png

Add class comment

Gopika Suresh
28 Oct 2023

Stream Classwork People



II BCA B COMPUTER ORGA...

Announce something to your class

Niranjan
16 Nov 2023

Niranjan A
22CA217

CO Assignment.pdf

Add class comment

Nisha
6 Nov 2023

Assignment

co assignment .pdf

Add class comment

Stream Classwork People

Shahitya Ravansiah
28 Oct 2023

Assignment

20211216100532_61bdb2...

IMO_20231026_210853.jpg

+ 1 attachment

Add class comment

Ancy B
28 Oct

Stream Classwork People

G. Velumalai
PRINCIPAL,
DHARMAMURTHI RAO BAHADUR CALAYALA
CUNNAM CHETTY'S HINDU COLLEGE,
DHARMAMURTHI NAGAR,
PATTABIRAM, CHENNAI - 600 072.

**DHARMAMURTHI RAO BHADHUR CALAVALA CUNNAN CHETTY'S
HINDU COLLEGE PATTABIRAM CHENNAI – 72.**

**DEPARTMENT OF COMPUTER APPLICATION
II-BCA-'B'**

ICT TOOLS STUDENTS – COMPUTER ORGANISATION

STUDENT GROUP STUDY AND TEST

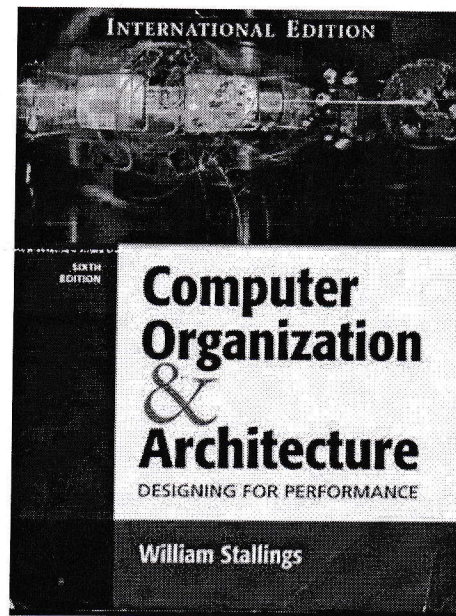
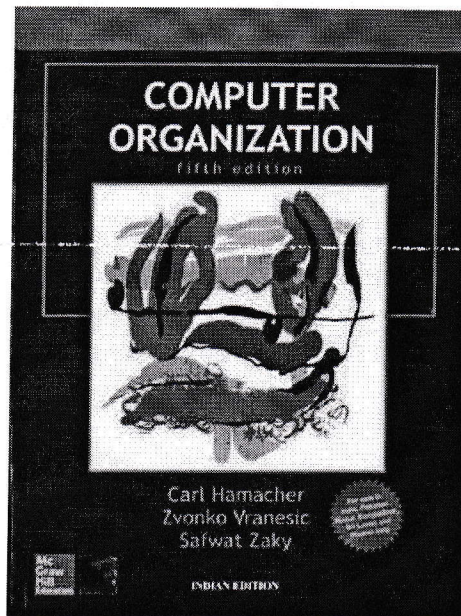
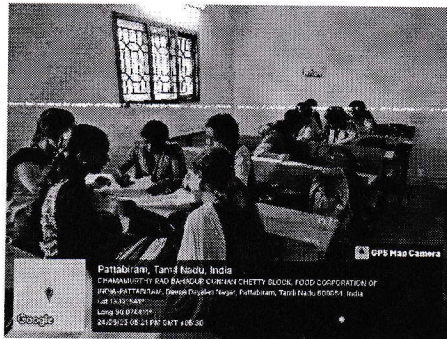

REFERENCE BOOKS:

1. Mathur- "Introduction to Microprocessor"- 3rd Edition- Tata McGraw-Hill-1993.
2. P. K. Ghosh and P. R. Sridhar- "0000 to 8085: Introduction to Microprocessors for Engineers and Scientists"- 2nd Edition- PHI- 1995.
3. NagoorKani- "Microprocessor (8085) and its Applications"- 2nd Edition- RBA Publications- 2006.
4. V. Vijayendran- "Fundamentals of Microprocessors – 8085"- S. Viswanathan Pvt. Ltd.- 2008.



C. Calankaray
PRINCIPAL,
DHARMAMURTHI RAO BHADHUR CALAVALA
CUNNAN CHETTY'S HINDU COLLEGE,
DHARMAPURAM, PATTABIRAM

GOOGLE CLASSROOM:

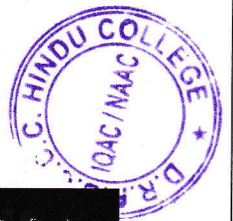
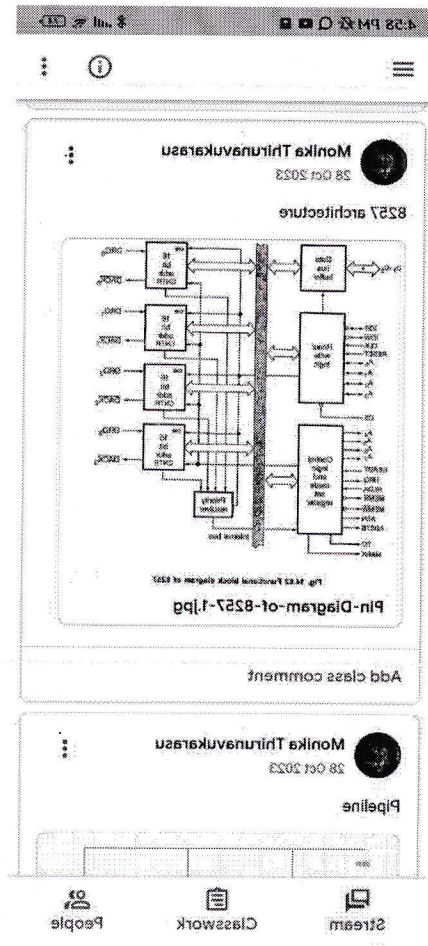
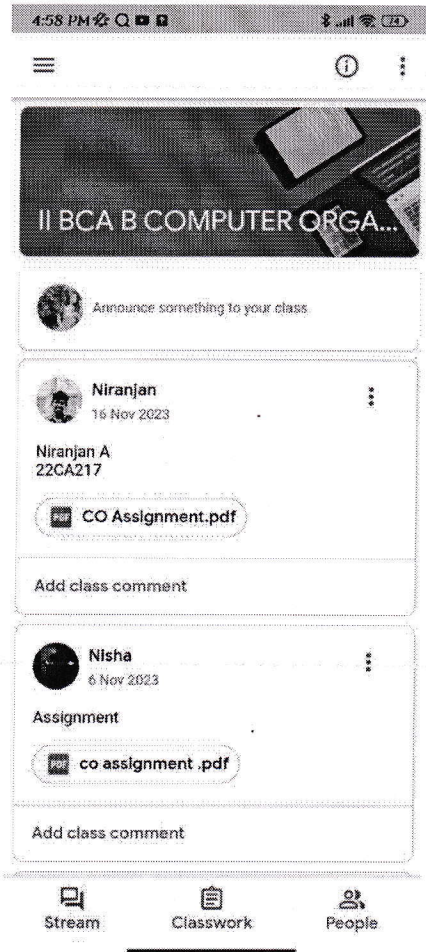

YOUTUBE VIDEO:

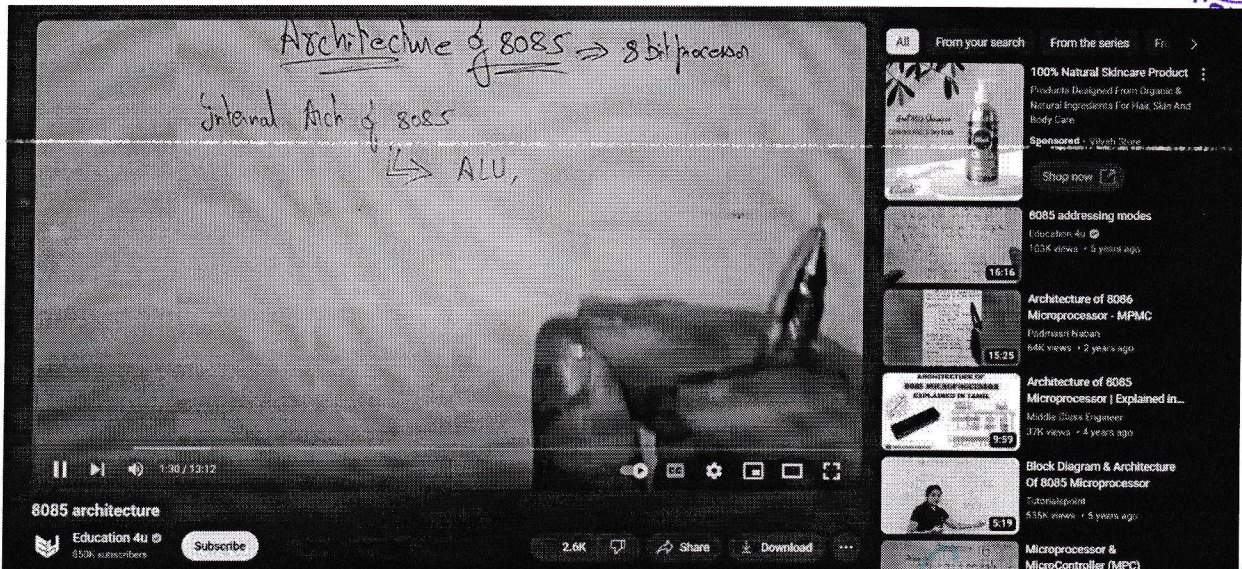

LINK:

<https://youtu.be/XEMyFUuV31o?si=mG90GxD4gueDt7fo>

C. Anand
 PRINCIPAL,
 BHARMAMURTHI RAO HINDU COLLEGE
 CHIMMANURTHI, HINDU COLLEGE

**DHARMAMURTHI RAO BAHADUR CALAVALA CUNNAN CHETTY'S HINDU
COLLEGE**

PATTABIRAM, CHENNAI-600 072

DEPARTMENT OF COMPUTER APPLICATIONS



ICT TOOLS

2023-2024

ODD SEMESTER



G. Kalimuthu
PRINCIPAL,
DHARMAMURTHI RAO BAHADUR CALAVALA
CUNNAN CHETTY'S HINDU COLLEGE,
DHARMAMURTHI NAGAR,
PATTABIRAM, CHENNAI - 600 072.

**DHARMAMURTHI RAO BHADHUR CALAVALA CUNNAN CHETTY'S
HINDU COLLEGE PATTABIRAM CHENNAI – 72.**

**DEPARTMENT OF COMPUTER APPLICATION
III-BCA-'B'**

ICT TOOLS STUDENTS - OPERATING SYSTEM

STUDENT GROUP STUDY AND TEST

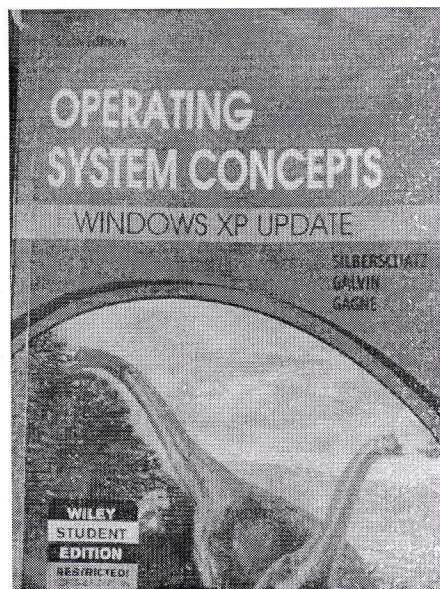

REFERENCES:

1. William Stallings, "Operating Systems Internals and Design Principles", Pearson, 2018, 9th Edition.
2. Andrew S. Tanenbaum, Herbert Bos, "Modern Operating Systems", Pearson 2014, 4th Edition.

GOOGLE CLASSROOM:

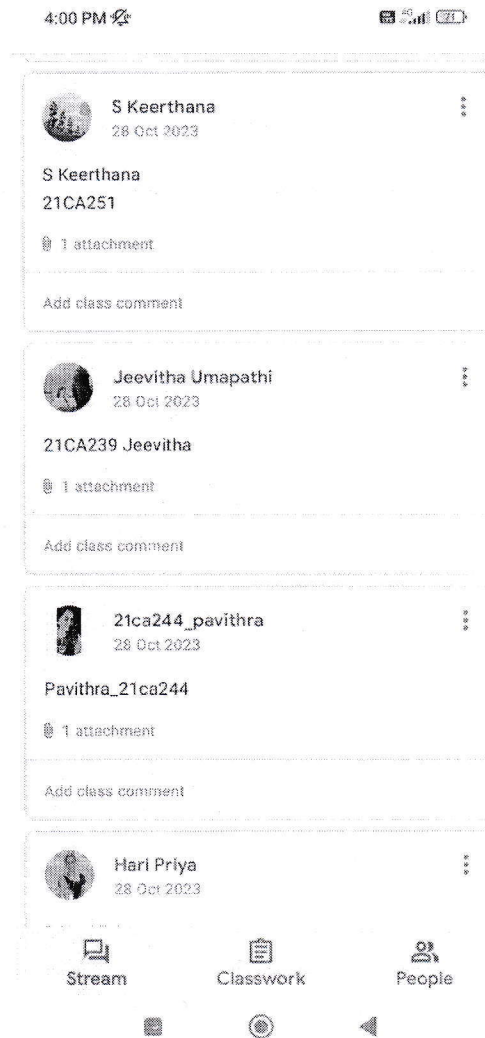

YOUTUBE VIDEO:

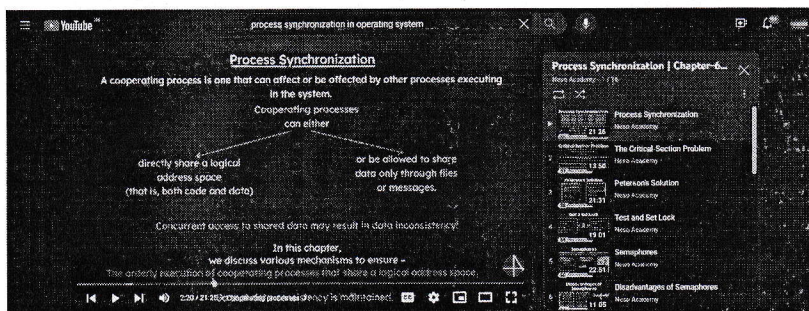

LINK:

<https://youtu.be/ph2awKa8r5Y?si=zPPjwnXA2XlAy6Nn>



G. Kalanidhi

PRINCIPAL,
DHARMAMURTHI RAO BHADUR CALAVALA
CUNNAN CHETTY HINDU COLLEGE,
DHARMAMURTHI NAGAR,
PATTABIRAM, CHENNAI - 600 072.

**DHARMAMURTHI RAO BHADHUR CALAVALA CUNNAN CHETTY'S
HINDU COLLEGE PATTABIRAM CHENNAI – 72.**

**DEPARTMENT OF COMPUTER APPLICATION
III-BCA-‘B’**

ICT TOOLS STUDENTS - SOFTWARE ENGINEERING

STUDENT GROUP STUDY AND TEST

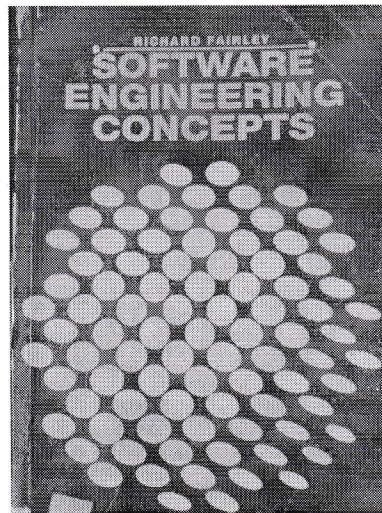
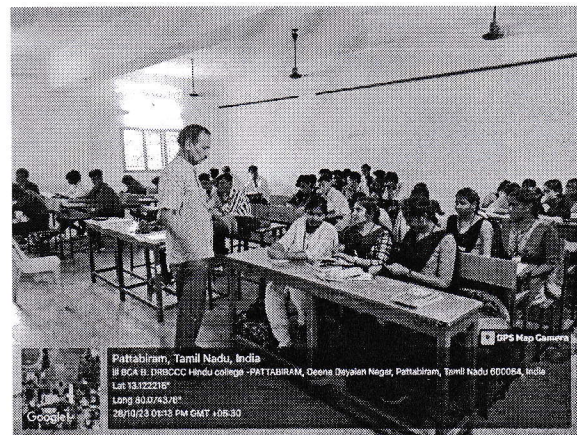

REFERENCE BOOKS:

1. Roger S. Pressman, “Software Engineering - A Practitioner’ s Approach” , McGraw Hill 2010, 7th Edition.
2. Pankaj Jalote, “An Integrated Approach to Software Engineering” , Narosa Publishing House 2011, 3rd Edition.

WEB REFERENCES:

- NPTEL & MOOC courses titled Software Engineering
- <https://nptel.ac.in/courses/106105182/>

YOUTUBE VIDEO:

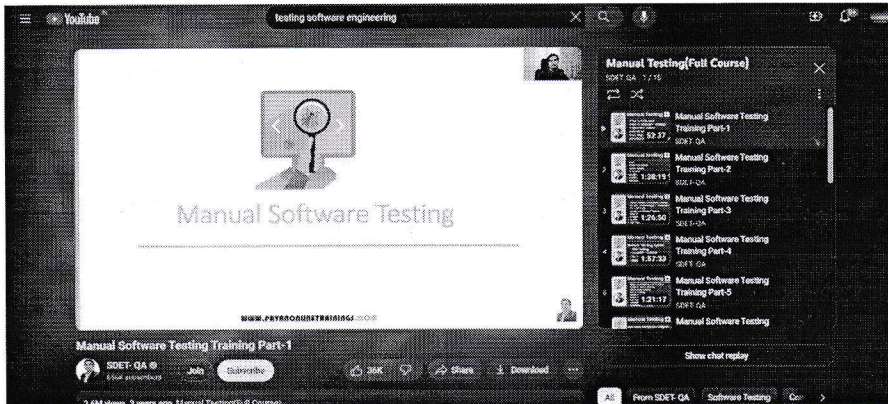

LINK:

<https://youtu.be/oOvURgHcd4w?si=Nf-ykCBCmW2JVRYC>



G. Gopinathan
PRINCIPAL,
DHARMAMURTHI RAO RAHADUR CALAVALA
CUNNAN CHETTI'S HINDU COLLEGE,
DHARMAMURTHI NAGAR,
PATTABIRAM, CHENNAI - 600 072.

**DHARMAMURTHI RAO BHADHUR CALAVALA CUNNAN CHETTY'S
HINDU COLLEGE PATTABIRAM CHENNAI – 72.**

**DEPARTMENT OF COMPUTER APPLICATION
III-BCA-‘B’**

ICT TOOLS STUDENTS - RDBMS

STUDENT GROUP STUDY AND TEST

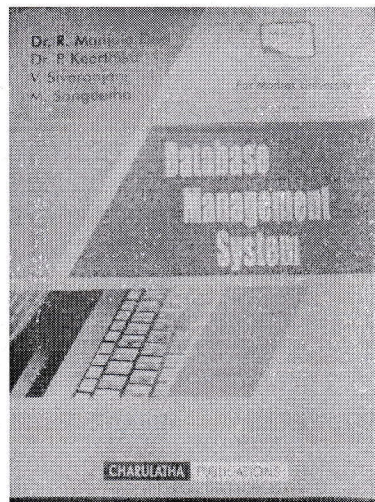
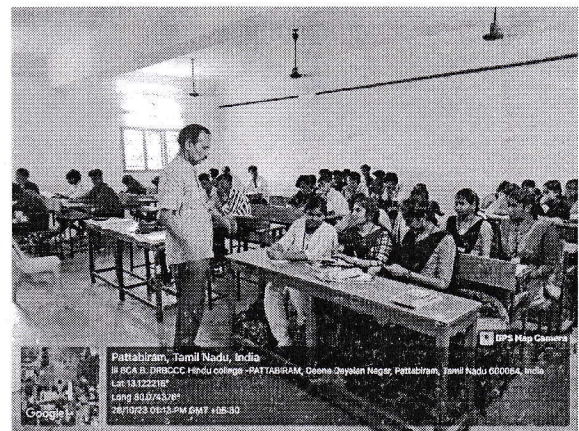
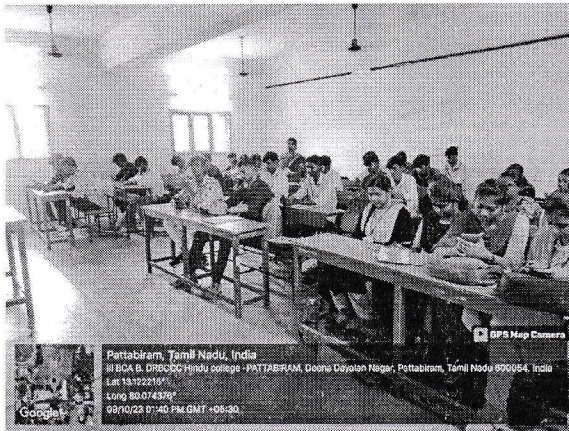

REFERENCE BOOKS:

1. Abraham Silberchatz, Henry F. Korth, S. Sudarshan, “Database System Concepts” , McGrawHill 2019, 7th Edition.
2. Alexis Leon & Mathews Leon, “Fundamentals of DBMS” , Vijay Nicole Publications 2014, 2nd Edition.

GOOGLE CLASSROOM:

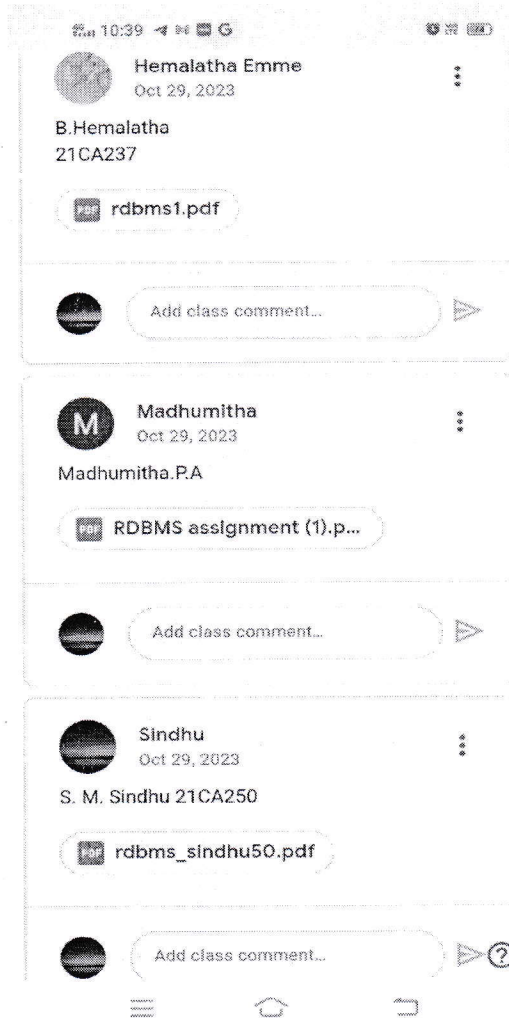
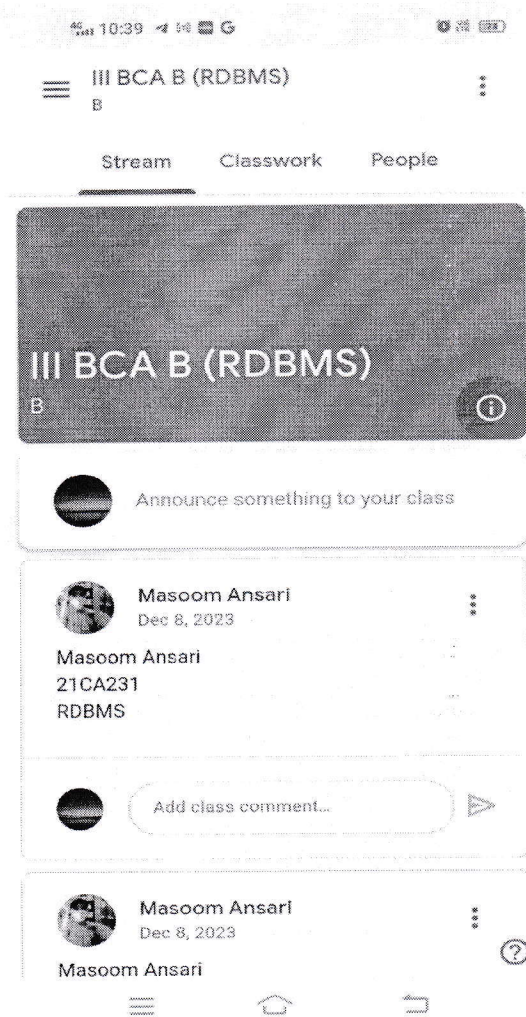

YOUTUBE VIDEO:

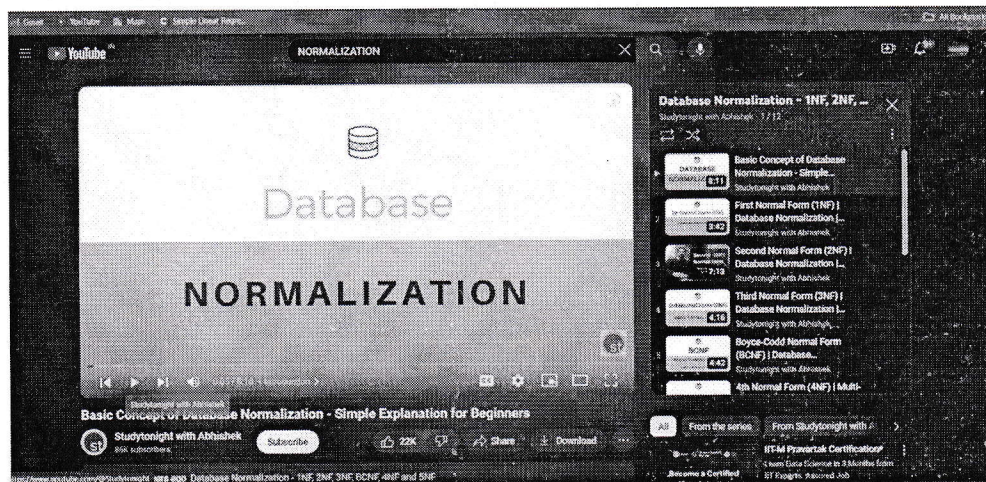

LINK:

<https://youtu.be/xoTyrdT9SZI?si=ExPYRZcGUuXaSCLA>



G. Kalin...
PRINCIPAL,
DHARMAMURTHI RAO BAHADUR CALAVALA
CUNNAN CHITRA HINDU COLLEGE,
DHARMAVARAM, NIMAGAR

**DHARMAMURTHI RAO BHADHUR CALAVALA CUNNAN CHETTY'S
HINDU COLLEGE PATTABIRAM CHENNAI – 72.**

**DEPARTMENT OF COMPUTER APPLICATION
III-BCA-'B'**

ICT TOOLS STUDENTS - MULTIMEDIA

STUDENT GROUP STUDY AND TEST

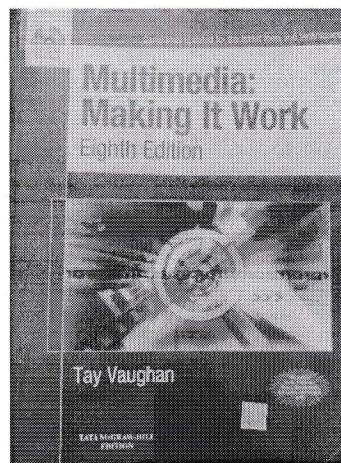
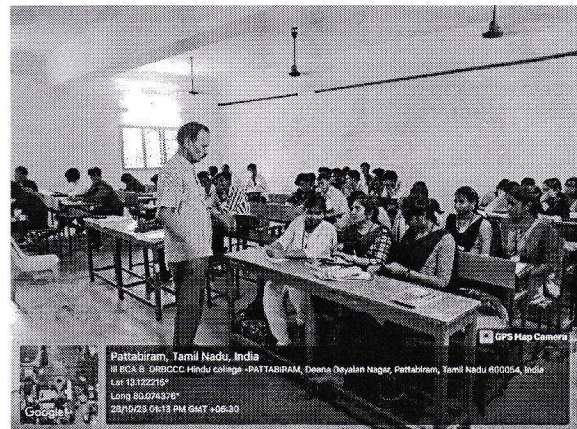

REFERENCE BOOKS: 1. Kiran Thakrar, Prabhat k.andleigh, "Multimedia System Design", Prentice Hall India, 1st Edition.

2. Malay k Pakhira, "Computer graphics, Multimedia and Animation", Prentice Hall India, 2nd Edition.

WEB REFERENCES:

- NPTEL & MOOC courses titled Multi media
- <https://nptel.ac.in/courses/106105163/>
- W3schools.com/html/html-media.asp

GOOGLE CLASSROOM:

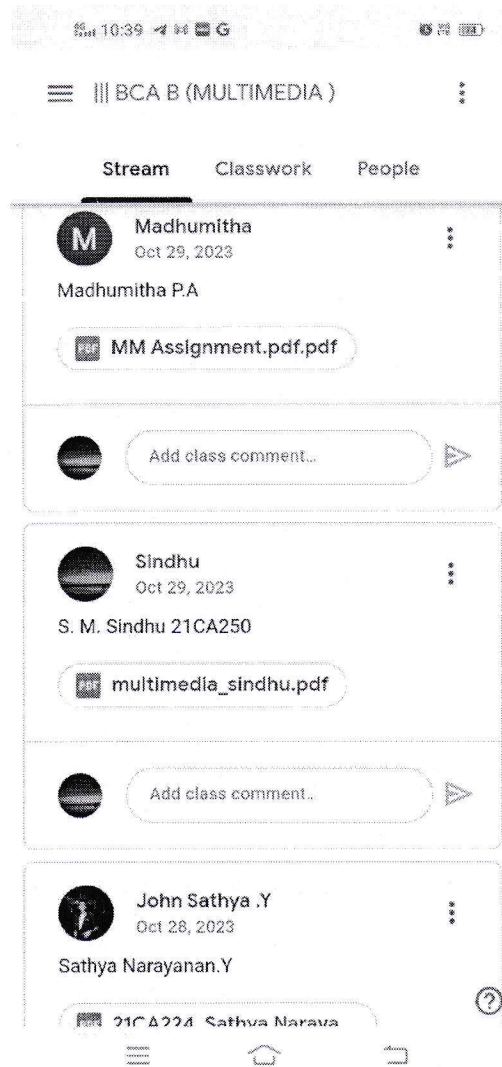
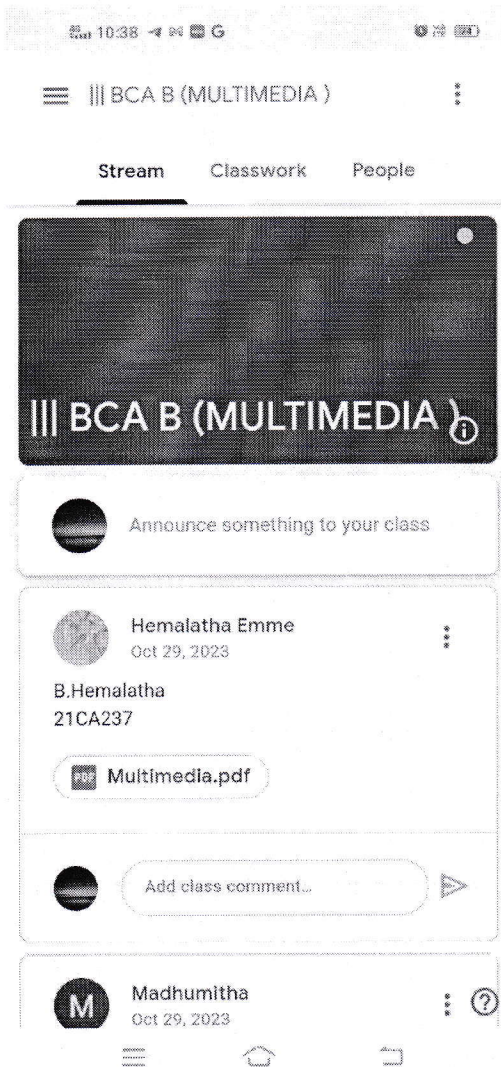

YOUTUBE VIDEO:

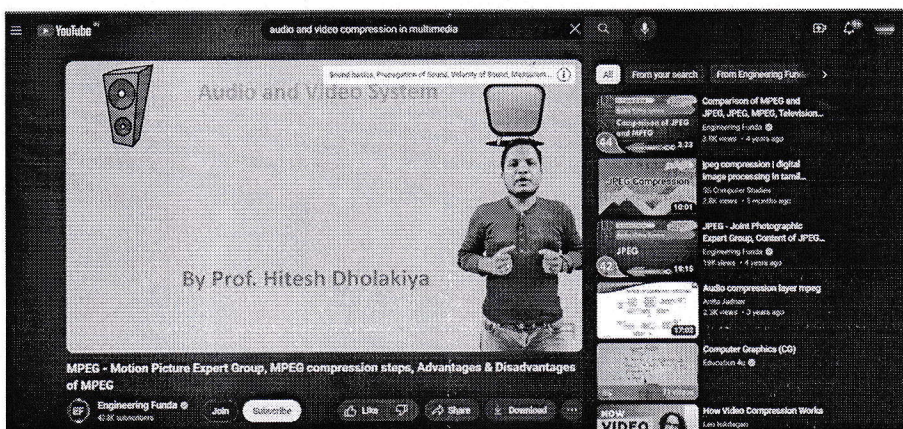

LINK:

<https://youtu.be/lAkuix41XJ8?si=yuHE7SDkaVa9KOjn>



G. Vasu Naray
PRINCIPAL,
DHARMAMURTHI RAO SAHADUR CALAVALA
CONNAN CHETTY'S HINDU COLLEGE,
DHARMAMURTHI NAGAR,
PATTANAMURTHI CHENNAI 600 070

**DHARMAMURTHI RAO BAHADUR CALAVALA CUNNAN CHETTY'S HINDU
COLLEGE**

PATTABIRAM, CHENNAI-600 072

DEPARTMENT OF COMPUTER APPLICATIONS



PEER TEACHING

ODD SEMESTER



G. Kalinmayi
PRINCIPAL,
DHARMAMURTHI RAO BAHADUR CALAVALA
CUNNAN CHETTY'S HINDU COLLEGE,
DHARMAMURTHI NAGAR,
PATTABIRAM, CHENNAI - 600 072.

**DHARMAMURTHI RAO BHADHUR CALAVALLA CUNNAN
CHETTY'S HINDU COLLEGE PATTABIRAM CHENNAI - 72.
DEPARTMENT OF COMPUTER APPLICATIONS
PEER TEACHING DATA STRUCTURE
II-BCA-A**

S.NO	REGNO	NAME	DETAILS	DATE
1	22CA133	DEEPIKA SRI	PEER TO PEER TEACHING	28.10.23
2	22CA101	AAKASH D	PEER TO PEER TEACHING	29.10.23
3	22CA112	LOKESH KUMAR P	PEER TO PEER TEACHING	01.11.23
4	22CA2127	SURENDAR BABU	PEER TO PEER TEACHING	04.11.23
5	22CA144	PRIYANKA S	PEER TO PEER TEACHING	06.11.23
6	22CA135	HEMMALINI	PEER TO PEER TEACHING	07.11.23

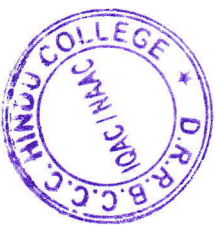

C. Vasimurthy

**PRINCIPAL,
DHARMAMURTHI RAO BHADHUR CALAVALLA
CUNNAN CHETTY'S HINDU COLLEGE,
DHARMAMURTHI NAGAR,
PATTABIRAM, CHENNAI - 600 072.**

**DHARMAMURTHI RAO BHADHUR CALAVALA CUNNAN
CHETTY'S HINDU COLLEGE PATTABIRAM CHENNAI - 72.
DEPARTMENT OF COMPUTER APPLICATIONS
PEER TEACHING JAVA
II-BCA-A**

S.NO	REGNO	NAME	DETAILS	DATE
1	22CA133	DEEPIKA SRI	PEER TO PEER TEACHING	28.10.23
2	22CA101	AAKASH D	PEER TO PEER TEACHING	29.10.23
3	22CA112	LOKESH KUMAR P	PEER TO PEER TEACHING	01.11.23
4	22CA2127	SURENDAR BABU	PEER TO PEER TEACHING	04.11.23
5	22CA144	PRIYANKA S	PEER TO PEER TEACHING	06.11.23
6	22CA135	HEMMALINI	PEER TO PEER TEACHING	07.11.23



C. Subramanyam

PRINCIPAL,
DHARMAMURTHI RAO BHADHUR CALAVALA
CHETTY'S HINDU COLLEGE,
PATTABIRAM, CHENNAI - 600 072.

**DHARMAMURTHI RAO BHADHUR CALAVALA CUNNAN
CHETTY'S HINDU COLLEGE PATTABIRAM CHENNAI - 72.
DEPARTMENT OF COMPUTER APPLICATIONS
PEER TEACHING ORGANIZATION**

II-BCA-A

S.NO	REGNO	NAME	DETAILS	DATE
1	22CA133	DEEPIKA SRI	PEER TO PEER TEACHING	28.10.23
2	22CA101	AAKASH D	PEER TO PEER TEACHING	29.10.23
3	22CA112	LOKESH KUMAR P	PEER TO PEER TEACHING	01.11.23
4	22CA2127	SURENDAR BABU	PEER TO PEER TEACHING	04.11.23
5	22CA144	PRIYANKA S	PEER TO PEER TEACHING	06.11.23
6	22CA135	HEMMALINI	PEER TO PEER TEACHING	07.11.23

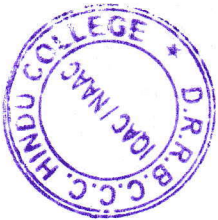

**PRINCIPAL,
DHARMAMURTHI RAO BHADHUR CALAVALA
CUNNAN CHETTY'S HINDU COLLEGE,
DHARMAMURTHI NAGAR,
PATTABIRAM, CHENNAI - 600 072.**

C. Valluvanaray

DHARMAMURTHI RAO BAHADUR CALAYALA CUNNAN CHETTY'S HINDU COLLEGE

PATTTABIRAM, CHENNAI-600 072

DEPARTMENT OF COMPUTER APPLICATIONS



PEER TEACHING

ODD SEMESTER

2023-2024

G. Viswanaray
PRINCIPAL,
DHARMAMURTHI RAO BAHADUR CALAYALA
CUNNAN CHETTY'S HINDU COLLEGE,
DHARMAMURTHI NAGAR,
PATTTABIRAM, CHENNAI - 600 072.

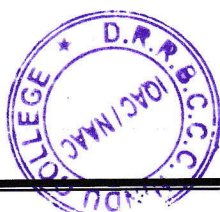

DHARMAMURTHI RAO BAHADUR CALAVALA CUNNAN CHETTY'S HINDU COLLEGE

PATTABIRAM CHENNAI - 72

DEPARTMENT OF COMPUTER APPLICATIONS

ADVANCE LEARNERS STUDENT LIST - 2022-2023

II BCA - "B" JAVA

S.NO	ROLLNO	REG NO	NAME	ACTIVITY	SIGNATURE
1	22CA203	212200216	ARUN KUMAR S	NATIONAL CONFERENCE	<i>S. Arun</i>
2	22CA204	212200218	ENOCH SMITH N	NATIONAL CONFERENCE	<i>N. Enoch</i>
3	22CA211	212200229	JAYA PRAKASH S	INTERNATIONAL, NATIONAL CONFERENCE	<i>S. Jayaprakash</i>
4	22CA222	212200258	SHARATH P	INTERNATIONAL, NATIONAL CONFERENCE	<i>P. Sri</i>
5	22CA226	212200264	VIGNESH D	INTERNATIONAL CONFERENCE	<i>Vignesh D</i>
6	22CA213	212200235	LOKESHWARAN N	SEMINAR / PEER TEACHING	<i>lokesh . A.</i>
7	22CA215	212200240	NAGARAJ M	SEMINAR / PEER TEACHING	<i>M. Nagaraj</i>
8	22CA220	212200248	RITHIK B	SEMINAR / PEER TEACHING	<i>R. Ritik</i>
9	22CA225	212200263	VANAPAL SELVAM M	SEMINAR / PEER TEACHING	<i>M. Vanapal Selvam</i>

FEMALE

10	22CA230	212200270	ANITHA I	INTERNATIONAL, NATIONAL CONFERENCE	<i>I. Anitha</i>
11	22CA232	212200276	DHANUSHREE R	CONFERENCE	<i>R. Dhanshree</i>
12	22CA233	212200277	GOPIKA S	CONFERENCE	<i>S. Gopika</i>
13	22CA234	212200279	HEMASREE D	INTERNATIONAL, NATIONAL CONFERENCE	<i>D. Hemasree</i>
14	22CA238	212200289	MONIKA T	INTERNATIONAL CONFERENCE	<i>T. Monika</i>

15	22CA239	212200290	NARMATHADEVI G	SEMINAR / PEER TEACHING	G. Narasimachandrar
16	22CA240	212200291	NITHYASRI A	INTERNATIONAL, NATIONAL CONFERENCE	A. Nithyasri
17	22CA241	212200293	PAVITHRA C	SEMINAR / PEER TEACHING	C Pavithra
18	22CA244	212200301	SHRI ILAKKIYA L Y	INTERNATIONAL, NATIONAL CONFERENCE	S. Shri Lakshmi
19	22CA245	2122002302	SREE NIDHI U	SEMINAR / PEER TEACHING	U. Sree Nidhi
20	22CA246	212200303	SWETHA S	INTERNATIONAL CONFERENCE	S. Swetha
21	22CA247	212200306	USHANJALI P	NATIONAL CONFERENCE	P. Ushanya
22	22CA248	212200308	JIGYA KEERTANAA P	INTERNATIONAL, NATIONAL CONFERENCE	J. Jyoti Keertana

P. Ushanya
SUBJECT INCHARGE

HEAD OF THE DEPARTMENT

D.R.N. VENKATARAMANAN,
M.E., M.Sc(Maths), M.Phil, PGDCA, B.Ed, Ph.D
Associate Professor & Head
Dept of Computer Applications
DRBCCC HINDU COLLEGE
Pattabiram, Chennai-600 072, TN, India.



C. Ushanya
PRINCIPAL,
DHARMANURTHI TAO BHADUR CALAVILA
CUNNAM CHITTAI HINDU COLLEGE,
DHARMANURTHI PUSAR,
PATTABIRAM, CHENNAI - 600 072.

DEPARTMENT OF COMPUTER APPLICATIONS

ADVANCE LEARNERS STUDENT LIST - 2022-2023

DATA STRUCTURES

II BCA - "B"

S.NO	ROLLNO	REG NO	NAME	ACTIVITY	DATE
1	22CA203	212200216	ARUN KUMAR S	PEER TEACHING	5.10.23
2	22CA204	212200218	ENOCH SMITH N	PEER TEACHING	7.10.23
3	22CA211	212200229	JAYA PRAKASH S	PEER TEACHING	10.10.23
4	22CA222	212200258	SHARATH P	PEER TEACHING	13.10.23
5	22CA226	212200264	VIGNESH D	PEER TEACHING	17.10.23

FEMALE

6.	22CA230	212200270	ANITHA I	PEER TEACHING	25.10.23
7.	22CA233	212200277	GOPIKA S	PEER TEACHING	4.11.23
8.	22CA234	212200279	HEMASREE D	PEER TEACHING	7.11.23
9.	22CA238	212200289	MONIKA T	PEER TEACHING	10.11.23
10.	22CA240	212200291	NITHYASRI A	PERSPECTIVE TEACHING	16.11.23
11.	22CA244	212200301	SHRI LAKKIYA L Y	PEER TEACHING	18.11.23
12.	22CA247	212200306	USHANJALI P	PERSPECTIVE TEACHING	21.11.23
13.	22CA248	212200308	JIGYA KEERTANAA P	PEER TEACHING	22.11.23

SUBJECT INCHARGE



C. Venkataramanan
PRINCIPAL
DI: ARMA MURTHI DAS RAJADUR CAIAVALA
CUNNINGHAM ENGINEERING COLLEGE,
DHARMSRAMPET, CHENNAI - 600 072.
PATYASRAM, CHENNAI - 600 072.

DR. N. VENKATARAMANAN,
ME, M.Sc(Maths), M.Phil, PGDCA, B.Ed, Ph.D
Associate Professor & Head
Dept. of Computer Applications
HEAD OF THE DEPARTMENT
Patyasarum, Chennai-600 072, TN, India

DEPARTMENT OF COMPUTER APPLICATIONS

ADVANCE LEARNERS STUDENT LIST - 2022-2023

COMPUTER ORGANIZATION

II BCA - "B"

S.NO	ROLLNO	REG NO	NAME	ACTIVITY	DATE
1	22CA203	212200216	ARUN KUMAR S	PEER TEACHING	5.10.23
2	22CA204	212200218	ENOCH SMITH N	PEER TEACHING	7.10.23
3	22CA211	212200229	JAYA PRAKASH S	PEER TEACHING	10.10.23
4	22CA222	212200258	SHARATH P	PEER TEACHING	13.10.23
5	22CA226	212200264	VIGNESH D	PEER TEACHING	17.10.23

FEMALE

6.	22CA230	212200270	ANITHA I	PEER TEACHING	25.10.23
7.	22CA233	212200277	GOPIKA S	PEER TEACHING	4.11.23
8.	22CA234	212200279	HEMASREE D	PEER TEACHING	7.11.23
9.	22CA238	212200289	MONIKA T	PEER TEACHING	10.11.23
10.	22CA240	212200291	NITHYASRI A	PERSPECTIVE TEACHING	16.11.23
11.	22CA244	212200301	SHRI ILAKKIYA L Y	PEER TEACHING	18.11.23
12.	22CA247	212200306	USHANJALI P	PERSPECTIVE TEACHING	21.11.23
13.	22CA248	212200308	JIGYA KEERTANAA P	PEER TEACHING	22.11.23

SUBJECT INCHARGE

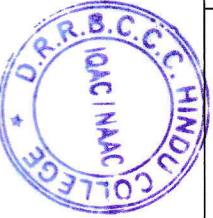

G. Subramanian
PRINCIPAL,
DHARMAMURTHI RAO SARADUR CALAWALA
(URBAN CHETIVS HINDU COLLEGE,
DHARMAMURTHI RAO SARADUR,
PATTABIRAM, CHENNAI - 600 072.

DR. N. VENKATARAMANAN,
M.E., M.Sc., M.Phil., PGDCA, B.Ed., Ph.D.
HEAD OF THE DEPARTMENT
DEPT. OF COMPUTER APPLICATIONS
DRACC HINDU COLLEGE,
Pattabiram, Chennai-600 072, TN, India.

**DHARMAMURTHI RAO BAHADUR CALAYALA CUNNAN CHETTY'S HINDU
COLLEGE**

PATTABIRAM, CHENNAI-600 072

DEPARTMENT OF COMPUTER APPLICATIONS



PEER TO PEER TEACHING

2023-2024

ODD SEMESTER



G. Kalinay
PRINCIPAL,
DHARMAMURTHI RAO BAHADUR CALAYALA
CUNNAN CHETTY'S HINDU COLLEGE,
DHARMAMURTHI RAO BAHADUR CALAYALA
PATTABIRAM, CHENNAI - 600 072.

DHARMAMURTHI RAO BHADHUR CALAVALA CUNNAN
CHETTY'S HINDU COLLEGE PATTABIRAM CHENNAI - 72.
DEPARTMENT OF COMPUTER APPLICATIONS
PEER TEACHING OPERATING SYSTEM
III-BCA-B

S.NO	REGNO	NAME	DETAILS	DATE
1	212100280	BHAVADHARANI . M	PEER TO PEER TEACHING	28.10.23
2	212100283	DIVYABHARATHIR	PEER TO PEER TEACHING	29.10.23
3	212100285	HARIPRIYA.D	PEER TO PEER TEACHING	01.11.23
4	212100287	JABHASTENA .M	PEER TO PEER TEACHING	04.11.23
5	212100289	JEEVITHA . U	PEER TO PEER TEACHING	06.11.23
6	212100302	RAKSHITHA .K	PEER TO PEER TEACHING	07.11.23
7	212100303	RANJINI .S	PEER TO PEER TEACHING	09.11.23
8	212100215	MADHUMITHA .P.A	PEER TO PEER TEACHING	13.11.23
9	212100214	GOGLA SHALINI	PEER TO PEER TEACHING	15.11.23

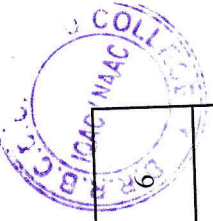

C. Subramanyam
PRINCIPAL,
DHARMAMURTHI RAO BHADHUR CALAVALA
CUNNAN CHETTY'S HINDU COLLEGE,
DHARMAMURTHI PAKAM,
PATTABIRAM, CHENNAI - 600 072.

DHARMAMURTHI RAO BHADHUR CALAVVALA CUNNAN
CHETTY'S HINDU COLLEGE PATTABIRAM CHENNAI - 72.
DEPARTMENT OF COMPUTER APPLICATIONS
PEER TEACHING SOFTWARE ENGINEERING
III-BCA-B

S.NO	REGNO	NAME	DETAILS	DATE
1	212100280	BHAVADHARANI . M	PEER TO PEER TEACHING	27.10.23
2	212100283	DIVYABHARATHI.R	PEER TO PEER TEACHING	01.11.23
3	212100285	HARIPRIYA.D	PEER TO PEER TEACHING	02.11.23
4	212100287	JABHASTENA .M	PEER TO PEER TEACHING	03.11.23
5	212100289	JEEVITHA . U	PEER TO PEER TEACHING	05.11.23
6	212100302	RAKSHITHA .K	PEER TO PEER TEACHING	07.11.23
7	212100303	RANJINI. S	PEER TO PEER TEACHING	08.11.23
8	212100215	MADHUMITHA .P.A	PEER TO PEER TEACHING	10.11.23
9	212100214	GOGLA SHALINI	PEER TO PEER TEACHING	12.11.23



PRINCIPAL,
DHARMAMURTHI RAO BHADHUR CALAVVALA
CUNNAN CHETTY'S HINDU COLLEGE,
DHARMAMURTHI NAGAR,
PATTABIRAM, CHENNAI - 600 072.

DHARMAMURTHI RAO BHADHUR CALAVALA CUNNAN
CHETTY'S HINDU COLLEGE PATTABIRAM CHENNAI - 72.
DEPARTMENT OF COMPUTER APPLICATIONS
PEER TEACHING RDBMS
III-BCA-B

S.NO	REGNO	NAME	DETAILS	DATE
1	212100280	BHAVADHARANI . M	PEER TO PEER TEACHING	27.10.23
2	212100283	DIVYABHARATHI.R	PEER TO PEER TEACHING	01.11.23
3	212100285	HARIPRIYA.D	PEER TO PEER TEACHING	02.11.23
4	212100287	JABHASTENA .M	PEER TO PEER TEACHING	03.11.23
5	212100289	JEEVITHA . U	PEER TO PEER TEACHING	05.11.23
6	212100302	RAKSHITHA .K	PEER TO PEER TEACHING	07.11.23
7	212100303	RANJINI. S	PEER TO PEER TEACHING	08.11.23
8	212100215	MADHUMITHA .P.A	PEER TO PEER TEACHING	10.11.23
9	212100214	GOGLA SHALINI	PEER TO PEER TEACHING	12.11.23

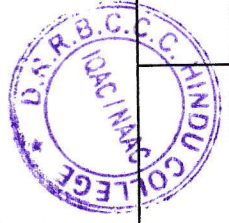

Co-ordinator

DHARMAMURTHI RAO BHADHUR CALAVALA
CUNNAN (CHETTY'S HINDU COLLEGE,
DHARMAMURTHI NAGAR,
PATTABIRAM, CHENNAI - 600 072.

**DHARMAMURTHI RAO BHADHUR CALAVALA CUNNAN
CHETTY'S HINDU COLLEGE PATTABIRAM CHENNAI - 72.
DEPARTMENT OF COMPUTER APPLICATIONS
PEER TEACHING MULTIMEDIA
III-BCA-B**

S.NO	REGNO	NAME	DETAILS	DATE
1	212100280	BHAVVADHARANI . M	PEER TO PEER TEACHING	28.10.23
2	212100283	DIVYABHARATHI.R	PEER TO PEER TEACHING	29.10.23
3	212100285	HARIPRIYA.D	PEER TO PEER TEACHING	01.11.23
4	212100287	JABHASTENA .M	PEER TO PEER TEACHING	04.11.23
5	212100289	JEEVITHA . U	PEER TO PEER TEACHING	06.11.23
6	212100302	RAKSHITHA .K	PEER TO PEER TEACHING	07.11.23
7	212100303	RANJINI. S	PEER TO PEER TEACHING	09.11.23
8	212100215	MADHUMITHA .P.A	PEER TO PEER TEACHING	13.11.23
9	212100214	GOGLA SHALINI	PEER TO PEER TEACHING	15.11.23

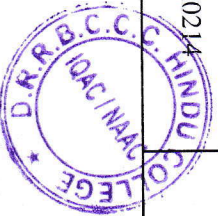

**PRINCIPAL,
DHARMAMURTHI RAO BHADHUR CALAVALA
CUNNAN CHETTY'S HINDU COLLEGE,
PATTABIRAM, CHENNAI - 600 072.**



**DHARMAMURTHI RAO BAHADUR
CALAVALA CUNNAN CHETTY'S HINDU COLLEGE**

"LINGUISTIC (TELUGU) MINORITY STATUS
CONFERRED BY THE GOVERNMENT OF TAMIL NADU"
(SHIFT 2 - Self Financing Stream)

NAAC with B+ Grade
Affiliated to University of Madras
DHARMAMURTHI NAGAR, PATTABIRAM, CHENNAI - 600 072.
Phone: 044-2630887
www.drbcchinducollege.ac.in E-mail: drbcchinducollege@yahoo.co.in



Sri M. Venkatesaperumal, B.A., F.C.A., Dr. (Smt.) Kalvikkarasi, M.A., M.Phil., Ph.D.,
Secretary

Dr.N. Rajendra Naidu, M.Com., M.Phil., Ph.D.
Director, Centre for Research and Development.

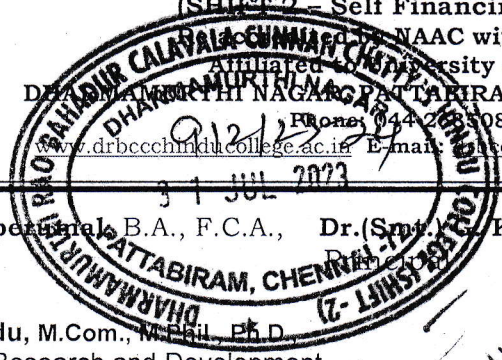

U-110/23-24
CBF:112
Dr: 31/7/23
31/7/23
31/7

Rc.No.21 / 2023-2024 (18) Dt. 27.07.2023

Sub: Dharmamurthi Rao Bahadur Calavala Cunnan Chetty's Hindu College (Shift 2)
- Bill - payment - cheque sending of - Reg.

Ref: Principal/Director's letter, Rc. No. 516 / 2023-2024 dt. 20.07.2023.

A cheque No. 709146 dated 26.07.2023 for Rs. 5,53,100/- (Rupees Five Lakhs Fifty Three Thousand and One Hundred only) drawn on Indian Overseas Bank, Pattabiram, Chennai-72 issued in favour of "CHALLENGER COMPUTER PVT. LTD.," from the College Account (IOB SB A/c. No.1) towards sanction of payment for purchase of Systems, Accessories and Server for various Departments, Library, NAAC Office, Placement Cell and Labs, is sent herewith.

Receipt of the letter and cheque may be acknowledged.

M. Venkatesaperumal
SECRETARY

M. Venkatesaperumal
M.VENKATESAPERUMAL
HONORARY SECRETARY 1/2

Encl: As above

To:
The Principal, Hindu College, Pattabiram, Chennai-72/ The Director, Centre for
Research and Development, Hindu College, Pattabiram, Chennai-72.
Gv 27.07.2023.

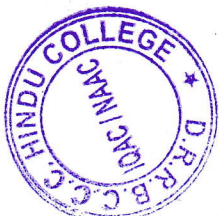

G. Kalvikkarasi
PRINCIPAL,
DHARMAMURTHI RAO BAHADUR CALAVALA
CUNNAN CHETTY'S HINDU COLLEGE,
DHARMAMURTHI NAGAR,
PATTABIRAM, CHENNAI - 600 072.

TAX INVOICE

(DUPLICATE FOR TRANSPORTER)

CHALLENGER COMPUTERS PVT LTD

832A, HEERA MARKET, ANNA SALAI
MOUNTRoad
GSTIN/UIN: 33AADCC6065B1Z5
State Name : Tamil Nadu, Code : 33
E-Mail : chacomp.mpm@rediffmail.com

Consignee (Ship to)

DRBCCC HINDU COLLEGE

DHAMAMURHTI NAGAR

PATTABIRAM

CHENNAI

State Name : Tamil Nadu, Code : 33

Buyer (Bill to)

DRBCCC HINDU COLLEGE

DHARMAMURTHI NAGAR

PATTABIRAM

CHENNAI

State Name : Tamil Nadu, Code : 33

Invoice No. CC-001824	e-Way Bill No. 541532453587	Dated 2-Aug-23
Delivery Note	Mode/Terms of Payment INVOICE	
Reference No. & Date.	Other References	
Buyer's Order No.	Dated	
Dispatch Doc No.	Delivery Note Date	
Dispatched through	Destination	

Terms of Delivery

SI No.	Description of Goods	HSN/SAC	Quantity	Rate (Incl. of Tax)	Rate	per	Amount
1	INTEL CORE I3 10100 PROCESSOR	84733010	12 NOS	9,900.00	8,389.83	NOS	1,00,677.96
2	MSI B560M PRO-E MOTHER BOARD	84733020	12 NOS	6,499.99	5,508.47	NOS	66,101.64
3	I5 12400 PROCESSOR	84717010	6 NOS	17,750.00	15,042.37	NOS	90,254.22
4	GIGABYTE H610 MH MOTHERBOARD	84733020	6 NOS	7,750.00	6,567.80	NOS	39,406.80
5	CRUCIAL 8GB DDR4 RAM	847330	17 NOS	2,250.00	1,906.78	NOS	32,415.26
6	CRUCIAL 16GB DDR4 RAM	84733030	2 NOS	3,500.00	2,966.10	NOS	5,932.20
7	256GB SSD	84717090	9 NOS	2,250.00	1,906.78	NOS	17,161.02
8	ATX CABINET	84733099	4 NOS	1,500.00	1,271.19	NOS	5,084.76
9	ZEBRONICS CABINET & 450W SMPS	84733099	2 NOS	3,899.99	3,305.08	NOS	6,610.16
10	DELL KEYBOARD & MOUSE	84716040	5 NOS	900.00	762.71	NOS	3,813.55
11	SEAGATE 1TB SATA HDD	84717020	8 NOS	3,500.00	2,966.10	NOS	23,728.80
12	SAMSUNG 24" LED MONITOR	85285200	2 NOS	9,500.00	8,050.85	NOS	16,101.70
13	DELL 24 LED MONITOR	85285200	2 NOS	7,500.00	6,355.93	NOS	12,711.86
14	CANON 2900 PRINTER	84433100	1 NOS	17,500.00	14,830.51	NOS	14,830.51
15	DELL T40 SERVER	85176290	1 NOS	57,500.00	48,728.81	NOS	48,728.81
							4,83,559.25
							43,520.33
							43,520.33
							0.09

OUTPUT CGST 9%
OUTPUT SGST 9%
ROUNDED OFF

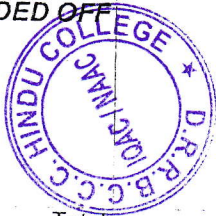

G. Kalimuthu
43,520.33
0.09

PRINCIPAL,
DHARMAMURTHI RAO BAHADUR CALAYALA
CUNNAN CHETTY'S HINDU COLLEGE,
DHARMAMURTHI NAGAR,
PATTABIRAM, CHENNAI - 600 072.

Total

89 NOS

₹ 5,70,600.00

E. & O.E

Amount Chargeable (In words)

INR Five Lakh Seventy Thousand Six Hundred Only

Declaration

We declare that this invoice shows the actual price of the goods described and that all particulars are true and correct.

for CHALLENGER COMPUTERS PVT LTD

Authorised Signatory

This is a Computer Generated Invoice

CHA
Prasad

Computer
₹ 5,53,100
₹ 17,500
₹ 5,70,600

11/23
12/23

Invoice No. CC-001824

TAX INVOICE
(Tax Analysis)

(DUPLICATE FOR TRANSPORTER)

Dated 2-Aug-23

CHALLENGER COMPUTERS PVT LTD
839A, HEERA MARKET, ANNA SALAI
MOUNTROAD

GSTIN/UIN: 33AADCC6065B1Z5
State Name : Tamil Nadu, Code : 33
E-Mail : chacomp.mpm@rediffmail.com

Party : **DRBCCC HINDU COLLEGE**
DHARMAMURTHI NAGAR
PATTABIRAM
CHENNAI

State Name : Tamil Nadu, Code : 33

HSN/SAC	Taxable Value	Central Tax		State Tax		Total Tax Amount
		Rate	Amount	Rate	Amount	
84733010	1,00,677.96	9%	9,061.02	9%	9,061.02	18,122.04
84733020	1,05,508.44	9%	9,495.76	9%	9,495.76	18,991.52
84717010	90,254.22	9%	8,122.88	9%	8,122.88	16,245.76
84733030	32,415.26	9%	2,917.37	9%	2,917.37	5,834.74
84717090	5,932.20	9%	533.90	9%	533.90	1,067.80
84733099	17,161.02	9%	1,544.49	9%	1,544.49	3,088.98
84716040	11,694.92	9%	1,052.54	9%	1,052.54	2,105.08
84717020	3,813.55	9%	343.22	9%	343.22	686.44
85285200	23,728.80	9%	2,135.59	9%	2,135.59	4,271.18
84433100	28,813.56	9%	2,593.22	9%	2,593.22	5,186.44
85176290	14,830.51	9%	1,334.75	9%	1,334.75	2,669.50
	48,728.81	9%	4,385.59	9%	4,385.59	8,771.18
Total	4,83,559.25		43,520.33		43,520.33	87,040.66

Tax Amount (in words) : **INR Eighty Seven Thousand Forty and Sixty Six paise Only**



G. Vallinarasu

PRINCIPAL,
DHARMAMURTHI RAO SAHADUR CALAVALA
CUNNAN CHETTY'S HINDU COLLEGE,
DHARMAMURTHI NAGAR,
PATTABIRAM, CHENNAI - 600 072.

for CHALLENGER COMPUTERS PVT LTD

Authorised Signatory



**DHARMAMURTHI RAO BAHADUR
CALAVALA CUNNAN CHETTY'S HINDU COLLEGE**

**"LINGUISTIC (TELUGU) MINORITY
CONFERRED BY THE GOVERNMENT OF TAMIL NADU"
(SHIFT 2 - Self Financing Stream)**

**Re-accredited by NAAC With B+ Grade
Affiliated to University of Madras**

DHARMAMURTHI NAGAR, PATTABIRAM, CHENNAI - 600 072.

Phone: 044-26850887

E-mail: drbccchinducollege@yahoo.co.in



Sri M. Venkatesaperumal, B.A., M.A., M.Phil., Ph.D.,
Secretary

Dr. (Smt.) G. Kalvikkarasi, M.A., M.Phil., Ph.D.,
Principal

Dr. N. Rajendra Naidu, M.Com., M.Phil., Ph.D.,
Director, Centre for Research and Development.

Rc. No. 21 / 2023-2024 (18) Dt. 29.04.2023

Sub: Dharmamurthi Rao Bahadur Calavala Cunnan Chetty's Hindu College (Shift 2)
- cheque sending of - Reg.

Ref: Principal/Director's letter, Rc. No. 86 / 2023-2024 dt. 24.04.2023.

A cheque No. 709027 dated 28.04.2023 for Rs. 70,650/- (Rupees Seventy Thousand Six Hundred and Fifty only) drawn on Indian Overseas Bank, Pattabiram, Chennai-72 issued in favour of "CHALLENGER COMPUTER PVT. LTD.," from the College Account (IOB SB A/c. No.1) towards sanction of payment for purchase of Dell Power Edge T40 - 1 No., SSD 480 GB - 3 Nos., SSD 1TB -1No., is sent herewith.

Receipt of the letter and cheque may be acknowledged.

M. Venkatesaperumal
SECRETARY

M. Venkatesaperumal
M.VENKATESAPERUMAL
HONORARY SECRETARY

Encl: as above.

To:
The Principal, Hindu College, Pattabiram, Chennai-72/ The Director, Centre for
Research and Development, Hindu College, Pattabiram, Chennai-72.

Gv 29.04.2023.

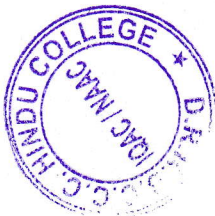

G. Kalvikkarasi
PRINCIPAL,
DHARMAMURTHI RAO BAHADUR CALAVALA
CUNNAN CHETTY'S HINDU COLLEGE,
DHARMAMURTHI NAGAR,
PATTABIRAM, CHENNAI - 600 072.

TAX INVOICE

CHALLENGER COMPUTERS PVT LTD
 NO.455/7, M.T.H ROAD,
 NEAR AMBATTUR OT BUS STAND,
 AMBATTUR, CHENNAI - 600 053
 GSTIN/UIN: 33AADCC6065B1Z5
 State Name : Tamil Nadu, Code : 33
 Contact : 044-4283 6978,80560 72229
 E-Mail : ccambattur@gmail.com
 Consignee (Ship to)

DRBCCC HINDU COLLEGE
 PATTABIRAM, CHENNAI
 State Name : Tamil Nadu, Code : 33
 Buyer (Bill to)

DRBCCC HINDU COLLEGE
 PATTABIRAM, CHENNAI
 State Name : Tamil Nadu, Code : 33

Invoice No. AC-00582	Dated 8-May-23
Delivery Note	Mode/Terms of Payment CHEQUE
Reference No. & Date.	Other References
Buyer's Order No.	Dated
Dispatch Doc No.	Delivery Note Date
Dispatched through	Destination
Terms of Delivery	

[Handwritten Signature]
 12/5/23

SI No.	Description of Goods	HSN/SAC	Quantity	Rate (Incl. of Tax)	Rate per	Amount
1	DELL T40 SERVER 93VV3N3	85176290	1 NOS	56,500.00	47,881.36 NOS	47,881.36
2	CRUCIAL BX500GB SATA SSD 2248E68D0C28 2248E68C0217 2248E68BFDA2	85235100	3 NOS	2,800.00	2,372.88 NOS	7,118.64
3	CRUCIAL 1TB SATA SSD 2304E6A383D8	85235100	1 NOS	5,750.00	4,872.88 NOS	4,872.88
						59,872.88
OUTPUT CGST 9%						5,388.56
OUTPUT SGST 9%						5,388.56

Entered in Stock Register
 Head : Computers and R & M Computer
 Page No. 6A

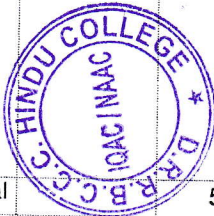

G. Kalimuthu
 PRINCIPAL,
 DHARMAMURTHI RAO BAHADUR CALAVALA
 ANNAN CHETTY'S HINDU COLLEGE,
 DHARMAMURTHI NAGAR,
 PATTABIRAM, CHENNAI - 600 072.

Total 5 NOS ₹ 70,650.00
 Amount Chargeable (in words) INR Seventy Thousand Six Hundred Fifty Only E. & O.E

HSN/SAC	Taxable Value	Central Tax		State Tax		Total Tax Amount
		Rate	Amount	Rate	Amount	
85176290	47,881.36	9%	4,309.32	9%	4,309.32	8,618.64
85235100	11,991.52	9%	1,079.24	9%	1,079.24	2,158.48
Total	59,872.88		5,388.56		5,388.56	10,777.12

Tax Amount (in words) : INR Ten Thousand Seven Hundred Seventy Seven and Twelve paise Only
 Remarks: CHEQUE DUE

Declaration
 We declare that this invoice shows the actual price of the goods described and that all particulars are true and correct.

for CHALLENGER COMPUTERS PVT LTD
CHALLENGER COMPUTER PVT. LTD.
 No. 455/7, Ambattur, Chennai-600 053.
 Authorised Signatory



**DHARMAMURTHI RAO BAHADUR
CALAVALA CUNNAN CHETTY'S HINDU COLLEGE**

**"LINGUISTIC (TELUUGU) MINORITY STATUS
CONFERRED BY THE GOVERNMENT OF TAMIL NADU"
(SHIFT 2 - Self Financing Stream)**

Re-accredited by NAAC with B+ Grade

Affiliated to University of Madras

DHARMAMURTHI NAGAR, PATTABIRAM, CHENNAI - 600 072.

Phone: 044-26850887

www.drbccchinducollege.ac.in E-mail: drbccchinducollege@yahoo.co.in



Sri M. Venkatesaperumal, B.A., F.C.A.,
Secretary

Dr.(Smt.) G. Kalvikkarasi, M.A., M.Phil., Ph.D.,
Principal

Dr.N. Rajendra Naidu, M.Com., M.Phil., Ph.D.,
Director, Centre for Research and Development.

Rc.No.21 / 2023-2024 (134) Dt. 20.11.2023

Sub: Dharmamurthi Rao Bahadur Calavala Cunnan Chetty's Hindu College
(Shift 2) - Bill - payment - cheque sending of - Reg.

Ref: Principal/Director's letter, Rc. No. 1107 / 2023-2024 dt. 14.11.2023.

A cheque No. 709342 dated 16.11.2023 for Rs. 9,00,000/- (Rupees Nine Lakhs only) drawn on Indian Overseas Bank, Pattabiram, Chennai-72 issued in favour of "SAJAAY TECHNOLOGIES" from the College Account (IOB SB A/c. No.1) towards sanction of Balance payment for supply of Intel Core i7 12700 Processor and other Accessories - 25 Nos. for the Computer Lab of Decennial Block, is sent herewith.

Receipt of the letter and cheque may be acknowledged.



SECRETARY

M.VENKATESAPERUMAL
HONORARY SECRETARY

Encl: As above

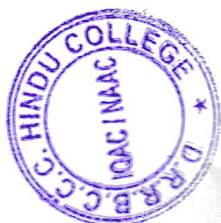
To:
The Principal, Hindu College, Pattabiram, Chennai-72/ The Director, Centre for
Research and Development, Hindu College, Pattabiram, Chennai-72.
Gv 20.11.2023.

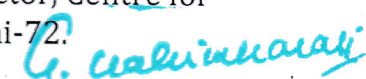

PRINCIPAL,
DHARMAMURTHI RAO BAHADUR CALAVALA
CUNNAN CHETTY'S HINDU COLLEGE,
DHARMAMURTHI NAGAR,
PATTABIRAM, CHENNAI - 600 072.

SALES INVOICES

(ORIGINAL FOR RECIPIENT)

Salaay Technologies
 Ground Floor, No.3, Krishnamoorthy Street,
 Bashyam Colony, Peravallur (Vetri Nagar)
 Chennai - 600 082
 Tamil Nadu
 GSTIN/UIN: 33AFAFS1717D1ZJ
 State Name : Tamil Nadu, Code : 33
 E-Mail : arun@salaay.com

Consignee (Ship to)

The Principal
 M/s. Dharamurthi Rao Bahadur Calavala Cunnam
 Chetty's Hindu College - SHIFT 2
 Dharamurthi Nagar, Pattabiram, Chennai - 600 072
 State Name : Tamil Nadu, Code : 33

Buyer (Bill to)
The Principal
 M/s. Dharamurthi Rao Bahadur Calavala Cunnam
 Chetty's Hindu College - SHIFT 2
 Dharamurthi Nagar, Pattabiram, Chennai - 600 072
 State Name : Tamil Nadu, Code : 33

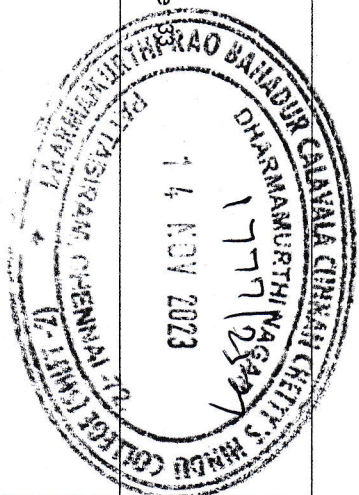

Invoice No. 2324/NOV001
 Dated 7-Nov-23
 Delivery Note
 Mode/Terms of Payment
 Reference No. & Date.
 Other References

Buyer's Order No.
 Dated
 Dispatch Doc No.
 Delivery Note Date
 Dispatched through
 Destination
 Terms of Delivery

Description of Goods	HSN/SAC	Part No.	Quantity	Rate	per	Amount	Taxable Value	CGST		SGST/UTGST		Total Amount
								Rate	Amount	Rate	Amount	
17 12700 Intel Core Processor	847330		25 Nos	25,000.00	Nos	6,25,000.00	6,25,000.00	9%	56,250.00	9%	56,250.00	7,37,500.00
24" LG IPS Monitor	852852	2AMP400	25 Nos	5,000.00	Nos	1,25,000.00	1,25,000.00	9%	11,250.00	9%	11,250.00	1,47,500.00
Seagate 1 TB SATA HDD Hard Disk	8471020	ST1000LM48	25 Nos	3,000.00	Nos	75,000.00	75,000.00	9%	6,750.00	9%	6,750.00	88,500.00
GIGABYTE B760M DS3H DDR5 Mother Board	847330		25 Nos	11,000.00	Nos	2,75,000.00	2,75,000.00	9%	24,750.00	9%	24,750.00	3,24,500.00
CRUCIAL 16 GB DDR5 4800 DT RAM	847330		25 Nos	2,000.00	Nos	50,000.00	50,000.00	9%	4,500.00	9%	4,500.00	59,000.00
Crucial P3 500GB SSD Nvme (CT500P3SSD8)	8471090	CRPD0089	25 Nos	2,000.00	Nos	50,000.00	50,000.00	9%	4,500.00	9%	4,500.00	59,000.00
Cooler Master Cabinet 310C	847330		25 Nos	2,400.00	Nos	60,000.00	60,000.00	9%	5,400.00	9%	5,400.00	70,800.00
CM SMPS MPES50W Bronze V2	847330		25 Nos	3,200.00	Nos	80,000.00	80,000.00	9%	7,200.00	9%	7,200.00	94,400.00
ZOTAC Gaming GTX 1650 OC 4 GB GDDR6 (ZT-T16520R-10L)	847330		25 Nos	10,807.00	Nos	2,70,175.00	2,70,175.00	9%	24,315.75	9%	24,315.75	3,18,806.50
						16,10,175.00						
						1,44,915.75						
						1,44,915.75						

CGST - Outward
 SGST - Outward

Received
[Signature]

continued ...

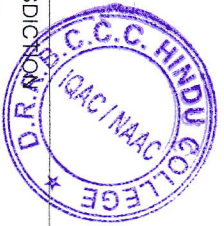

PRINCIPAL,
 DHARAMURTHI RAO BAHADUR CALAVALA
 CUNNAM CHETTY'S HINDU COLLEGE,
 PATTABIRAM, CHENNAI - 600 072.

SUBJECT TO CHENNAI JURISDICTION

This is a Computer Generated Invoice

aluv

AV Technologies
 2nd Floor, No.3, Krishnamoorthy Street,
 Athiyam Colony, Peravallur (Vetri Nagar),
 Chennai - 600 082
 Tamil Nadu
 GSTIN/UIN: 33AFAFS1717D1ZJ
 State Name : Tamil Nadu, Code : 33
 E-Mail : arun@sajaay.com

Invoice No. **2324/NOV001** Dated **7-Nov-23**
 Delivery Note Model/Terms of Payment
 Reference No. & Date: Other References
 Buyer's Order No. Dated
 Dispatch Doc No. Delivery Note Date
 Dispatched through Destination
 Terms of Delivery

The Principal
 M/s. Dharamamurthi Rao Bahadur Calavala Cunnan
 Chetty's Hindu College - SHIFT 2
 Dharamamurthi Nagar, Pattabiram, Chennai - 600 072
 State Name : Tamil Nadu, Code : 33

Buyer (Bill to)
The Principal
 M/s. Dharamamurthi Rao Bahadur Calavala Cunnan
 Chetty's Hindu College - SHIFT 2
 Dharamamurthi Nagar, Pattabiram, Chennai - 600 072
 State Name : Tamil Nadu, Code : 33

Description of Goods	HS/NSAC	Part No.	Quantity	Rate	per	Amount	Taxable		CGST		SGST/UTGST		Total
							Value	Rate	Amount	Rate	Amount	Rate	
Rounding Off						(-) 6.50							
Total			225 Nos			₹ 19,00,000.00	16,10,175.00	9%	1,44,915.75	1,44,915.75	9%	1,44,915.75	2,89,831.50

Amount Chargeable (in words) **INR Nineteen Lakh Only**

E. & O E

Tax Amount (in words) : **INR Two Lakh Eighty Nine Thousand Eight Hundred Thirty One and Fifty paise Only**

Declaration
 We declare that this invoice shows the actual price of the goods described and that all particulars are true and correct.
 Repairs / Replacements are subject to Manufacturer's Policy / Warranty Void on Product if mishandled / burnt / Physically damaged.
 Customer's Seal and Signature

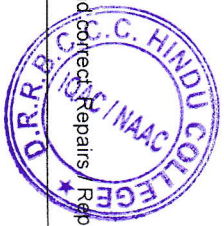

PRINCIPAL,
DHARAMAMURTHI RAO BAHADUR CALAVALA
CUNNAM CHETTY'S HINDU COLLEGE,
DHARAMAMURTHI NAGAR,
PATTABIRAM, CHENNAI - 600 072.

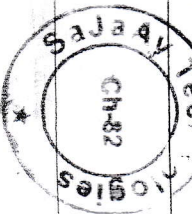

for Sajaay Technologies

Authorised Signatory

e-Way Bill



E-Way Bill No: **5215 7242 5595**
E-Way Bill Date: **07/11/2023 12:25 PM**
Generated By: **33AFA FS171 7D1ZJ - SaJaAy Technologies**
Valid From: **07/11/2023 12:25 PM [25Kms]**
Valid Until: **08/11/2023**

Part - A

GSTIN of Supplier: **33AFASF1717D1ZJ, SaJaAy Technologies**
Place of Dispatch: **Chennai, TAMIL NADU-600082**
GSTIN of Recipient: **URP ,THE PRINCIPAL DRBCC CHETTYS HINDU COLLEGE SHIFT2**
Place of Delivery: **PATTABIRAM, TAMIL NADU-600072**
Document No.: **2324/NOV001**
Document Date: **07/11/2023**
Transaction Type: **Regular**
Value of Goods: **1900000**
HSN Code: **847330 -**
Reason for Transportation: **Outward - Supply**

G. Calamunagai



PRINCIPAL,
DHARMAMURTHI RAO BANADUR CALAVALA
CUNNAN CHETTY'S HINDU COLLEGE,
DHARMAMURTHI NAGAR,
PATTABIRAM, CHENNAI - 600 072.

Part - B

Mode	Vehicle / Trans Doc No & Dt.	From	Entered Date	Entered By	CEWB No. (If any)	Multi Veh.Info (If any)
Road	TN05AR1801	Chennai	07/11/2023 12:25 PM	33AFASF1717D1ZJ	-	-



521572425595



**DHARMAMURTHI RAO BHADUR
CALAVALA CUNNAN CHETTY'S HINDU COLLEGE**

"LINGUISTIC (JGU) MINORITY STATUS
CONFERRED BY THE GOVERNMENT OF TAMIL NADU"

(Shift 2) Self Financing Stream)

Re-accredited by NAAC with B+ Grade

Affiliated to University of Madras

DHARMAMURTHI NAGAR, PATTABIRAM, CHENNAI - 600 072.

Phone: 044-26850887

www.drbccchinducollege.ac.in E-mail: drbccchinducollege@yahoo.co.in



Sri M. Venkatesaperumal, B.A., F.C.A.,
Secretary

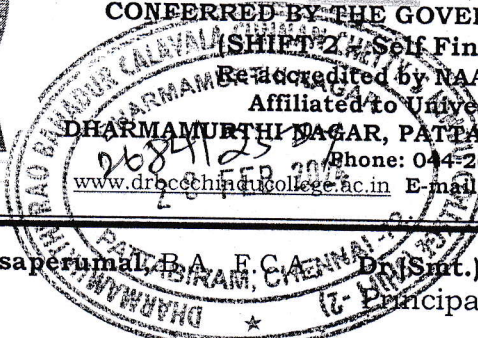

(Smt.) G. Kalvikkarasi, M.A., M.Phil., Ph.D.,
Principal

Dr.N. Rajendra Naidu, M.Com., M.Phil., Ph.D.,
Director, Centre for Research and Development.

Rc. No. 21 / 2023-2024 (210) Dt. 26.02.2024

V-358/23-24
CBF-116
28/2/24
28/2/24
28/2
C
28/2

Sub: Dharmamurthi Rao Bahadur Calavala Cunnan Chetty's Hindu College
(Shift 2) - cheque sending of - Reg.

Ref: Principal/Director's letter, Rc. No. 1564/ 2023-2024 dated 21.02.2024.

A cheque No. 709496 dated 24.02.2024 for Rs.49,900/- (Rupees Forty Nine Thousand and Nine Hundred only) drawn on Indian Overseas Bank, Pattabiram, Chennai-72 issued in favour of "SRI VARI SYSTEMS AND WEB SOLUTIONS" from the College Account (IOB SB A/c. No.1) towards sanction of payment for purchase of Laptop: HP15S-FQ5329TU 12th Gen./Intel 15/8GB SSD/ Webcam/ Bluetooth/ Wifi/ Card Reader/Intel IRIS Graphics/15.06" FHD Screen/Window11 - 1No., for our Director's Office, is sent herewith.

Receipt of the letter and cheque may be acknowledged.

M. Venkatesaperumal
SECRETARY

G. Kalvikkarasi *M. Venkatesaperumal*

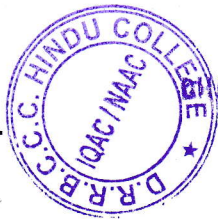

PRINCIPAL,
DHARMAMURTHI RAO BHADUR CALAVALA
CUNNAN CHETTY'S HINDU COLLEGE,
DHARMAMURTHI NAGAR,
PATTABIRAM, CHENNAI - 600 072.

M.VENKATESAPERUMAL
HONORARY SECRETARY

Encl: as above.

To:
The Principal, Hindu College, Pattabiram, Chennai-72/ The Director, Centre for
Research and Development, Hindu College, Pattabiram, Chennai-72.
Gv 26.02.2024.

1998

GST INVOICE / DELIVERY CHALLAN No. 6451

Date: 27/2/24

SRIVARI SYSTEMS & WEB SOLUTIONS

No. 1/17, Welcome Colony, Thiruvangalamb, Anna Nagar West, Chennai - 600 101.

GSTIN: 33ADXPA8543N1Z

Service : 4353 8805

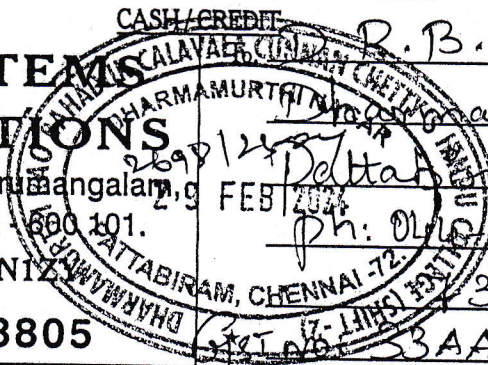

R. B. C. C. Hindu College

Dharmamurthi Nagar,

Delta Nagar, Chennai - 600 072.

Ph: 044-26850887

397387413

33AAATM0845M12K

S.No.	PARTICULARS	Qty.	AMOUNT
1.	<p><u>HP LAPTOP</u></p> <p>Model no: 15s-FA5329TU</p> <p>S/n: 5CD34929MX</p> <p>Intel Core i5 Processor 12th Gen, 8GB Ram, 512GB SSD, Webcam, Bluetooth, Wifi, Card Reader, Intel Iris Graphics, 15.6" FHD Screen, Windows 11 Home + MS Office Preloaded. <u>Free</u>: Bag.</p>	1/NO	42288.13
			3805.93
			3805.93
			0.01
TOTAL			49900.00

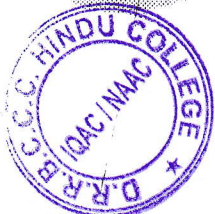

C. Kaliraj
PRINCIPAL,
DHARMAMURTHI RAO BAHADUR CALAVALA
CUNNAN CHETTY'S HINDU COLLEGE,
DHARMAMURTHI NAGAR,
PATTABIRAM, CHENNAI - 600 072.

Note:

1. Free Items no Guarantee
2. Warranty must be claimed directly from manufacturer only.
3. Total Value, Including GST
4. Goods once sold cannot be taken back.

M/E.....*Muri*.....

S/E.....*Kuppusamy*.....

CGST @ 9 % 3805.93
 SGST @ 9 % 3805.93
 CGST @ %
 SGST @ %
 Rounding Off - 0.01



Received the above goods in good condition.

For SRIVARI SYSTEMS & WEB SOLUTIONS

Receiver's Signature with Stamp

Received
cheque
S. Krt
7358763262

R.V
Authorised Signature



R
21/7/23

Q
21/7
A
21/7/23

INVOICE NO	ET/PI-062
DATE	21.07.2023
ORDER NO.	21/2023-2024/87
DATE	20.07.2023
TERMS	100% payment on delivery

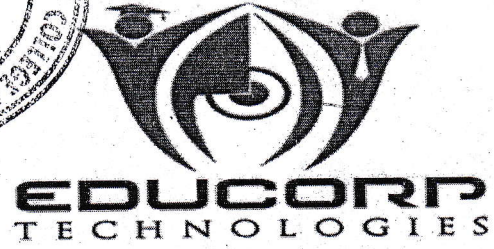

Old No.23/3, New No.59, South Usman Rd.,
T.Nagar, Chennai-600 017
Ph : 044-24341325
Email : educorpotech@gmail.com
website: www.educorpotech.com
GST : 33AADFE9415E1ZR

BILL TO
The Director,
Dharmamurthi Rao Bahadur Calavala
Cunnan Chetty's Hindu College,
Dharmamurthi Nagar, Pattabiram,
Chennai - 600 072.

SL.NO	DESCRIPTION OF GOODS	HSN CODE	QTY	RATE/UNIT	AMOUNT
1	Viewsonic Long Throw Multimedia Projector Model : PA503W	8528	3 Nos	34,500.00	1,03,500.00
	ADD CGST @ 14%				14,490.00
	SGST @ 14%				14,490.00
	TOTAL				1,32,480.00

(Rupees One Lakh Thirty Two Thousand Four Hundred and Eighty only)

1. BBA
2. D S
3. A I

Entered in Stock Register
Head Projector
Page No. 100

Our Bank Details:
BANK NAME : UNION BANK OF INDIA
BRANCH : WEST MAMBALAM, CHENNAI
ACCOUNT NO (CC) : 611705080000103
ACCOUNT NAME : EDUCORP TECHNOLOGIES
IFSC CODE : UBIN0561177

All disputes are subject to Chennai Jurisdiction only
We declare that this invoice shows the actual price of
the goods described and that all particulars are true and correct

for EDUCORP TECHNOLOGIES
(AUTHORISED SIGNATURE)
CHENNAI
600 017

R
21/7/23

Dharmamurthi Rao Bahadur
Dharmamurthi Rao Bahadur
Calavala Cunnan Chetty's Hindu College (Shift 2)
Dharmamurthi Nagar,
Pattabiram, Chennai-600072.

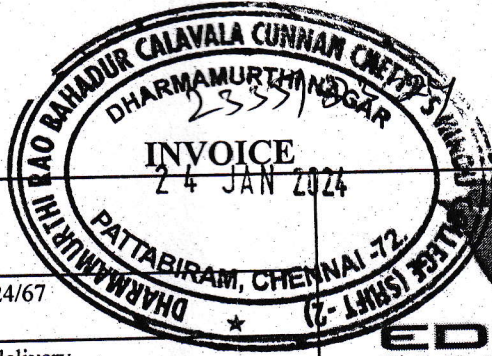

23/1/24 24/1/24

23/1

INVOICE NO	ET/PI-176 /23-24
DATE	23.01.2024
ORDER NO.	Re.No.21/2023-2024/67
DATE	12.01.2024
TERMS	100% payment on delivery
BILL TO	
The Director, Dharmamurthi Rao Bahadur Calavala Cunnan Chetty's Hindu College, Dharmamurthi Nagar, Pattabiram, Chennai - 600 072.	 EDUCORP TECHNOLOGIES Old No.23/3, New No.59, South Usman Rd., T.Nagar, Chennai-600 017 Ph : 044-24341325 Email : educorptech@gmail.com website: www.educorptech.com GST : 33AADFE9415E1ZR

SL.NO	DESCRIPTION OF GOODS	HSN CODE	QTY	RATE/UNIT	AMOUNT
1	Portable PA Speaker (Sl.No: SE90088095, SE90087385, SE90087386, SE90087964, SE90086239 SE90088040)	8518	6 Nos	5,000.00	30,000.00
	ADD CGST @ 9%				2,700.00
	SGST @ 9%				2,700.00
	TOTAL				35,400.00

(Rupees Thirty Five Thousand Four Hundred only)

Dra. Sri Math

Dharmamurthi Rao Bahadur
Calavala Cunnan Chetty's Hindu College (Shift -
Dharmamurthi Nagar,
Pattabiram, Chennai-600072.

Our Bank Details:
 BANK NAME : UNION BANK OF INDIA
 BRANCH : WEST MAMBALAM, CHENNAI
 ACCOUNT NO (CC) : 611705080000103
 ACCOUNT NAME : EDUCORP TECHNOLOGIES
 IFSC CODE : UBIN0561177

All disputes are subject to Chennai Jurisdiction only
 We declare that this invoice shows the actual price of
 the goods described and that all particulars are true and correct

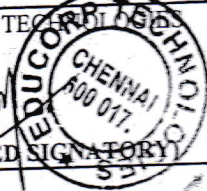
for EDUCORP TECHNOLOGIES

 (AUTHORISED SIGNATORY)

B. Srinivasan 23/1/24
Revised
M. Srinivasan
M. Srinivasan

TAX INVOICE

(DUPLICATE FOR TRANSPORTER)

CHALLENGER COMPUTERS PVT LTD
 832A, HEERA MARKET, ANNA SALAI
 MOUNTRoad
 GSTIN/UIN: 33AADCC6065B1Z5
 State Name : Tamil Nadu, Code : 33
 E-Mail : chacomp.mpm@rediffmail.com
 Consignee (Ship to)
DRBCCC HINDU COLLEGE
 DHAMAMURHTI NAGAR
 PATTABIRAM
 CHENNAI
 State Name : Tamil Nadu, Code : 33
 Buyer (Bill to)
DRBCCC HINDU COLLEGE
 DHARMAMURTHI NAGAR
 PATTABIRAM
 CHENNAI
 State Name : Tamil Nadu, Code : 33

Invoice No.	e-Way Bill No.	Dated
CC-001824	541532453587	2-Aug-23
Delivery Note	Mode/Terms of Payment	
	INVOICE	
Reference No. & Date.	Other References	
Buyer's Order No.	Dated	
Dispatch Doc No.	Delivery Note Date	
Dispatched through	Destination	
Terms of Delivery		

SI No.	Description of Goods	HSN/SAC	Quantity	Rate (Incl. of Tax)	Rate	per	Amount
1	INTEL CORE I3 10100 PROCESSOR	84733010	12 NOS	9,900.00	8,389.83	NOS	1,00,677.96
2	MSI B560M PRO-E MOTHER BOARD	84733020	12 NOS	6,499.99	5,508.47	NOS	66,101.64
3	I5 12400 PROCESSOR	84717010	6 NOS	17,750.00	15,042.37	NOS	90,254.22
4	GIGABYTE H610 MH MOTHERBOARD	84733020	6 NOS	7,750.00	6,567.80	NOS	39,406.80
5	CRUCIAL 8GB DDR4 RAM	847330	17 NOS	2,250.00	1,906.78	NOS	32,415.26
6	CRUCIAL 16GB DDR4 RAM	84733030	2 NOS	3,500.00	2,966.10	NOS	5,932.20
7	256GB SSD	84717090	9 NOS	2,250.00	1,906.78	NOS	17,161.02
8	ATX CABINET	84733099	4 NOS	1,500.00	1,271.19	NOS	5,084.76
9	ZEBRONICS CABINET & 450W SMPS	84733099	2 NOS	3,899.99	3,305.08	NOS	6,610.16
10	DELL KEYBOARD & MOUSE	84716040	5 NOS	900.00	762.71	NOS	3,813.55
11	SEAGATE 1TB SATA HDD	84717020	8 NOS	3,500.00	2,966.10	NOS	23,728.80
12	SAMSUNG 24" LED MONITOR	85285200	2 NOS	9,500.00	8,050.85	NOS	16,101.70
13	DELL 24 LED MONITOR	85285200	2 NOS	7,500.00	6,355.93	NOS	12,711.86
14	CANON 2900 PRINTER	84433100	1 NOS	17,500.00	14,830.51	NOS	14,830.51
15	DELL T40 SERVER	85176290	1 NOS	57,500.00	48,728.81	NOS	48,728.81

4,83,559.25
 43,520.33
 43,520.33
 0.09

OUTPUT CGST 9%
 OUTPUT SGST 9%
 ROUNDED OFF



G. Gopinath
 PRINCIPAL,
 DHARMAMURTHI RAO BAHADUR CALAVALA CUNNAM
 CHETTY'S HINDU COLLEGE
 DHARMAMURTHI NAGAR, PATTABIRAM,
 CHENNAI - 600072.

Total 89 NOS ₹ 5,70,600.00

Amount Chargeable (in words) **INR Five Lakh Seventy Thousand Six Hundred Only** E. & O.E

Declaration
 We declare that this invoice shows the actual price of the goods described and that all particulars are true and correct.

for CHALLENGER COMPUTERS PVT LTD
 [Signature]
 Authorised Signatory

This is a Computer Generated Invoice

CHA
[Signature]

Dr. U. Sanjath
 Dharmamurthi Rao Bahadur
 Calavala Cunnam Chetty's Hindu College (Shift 2),
 Dharmamurthi Nagar,
 Pattabiram, Chennai-600072.

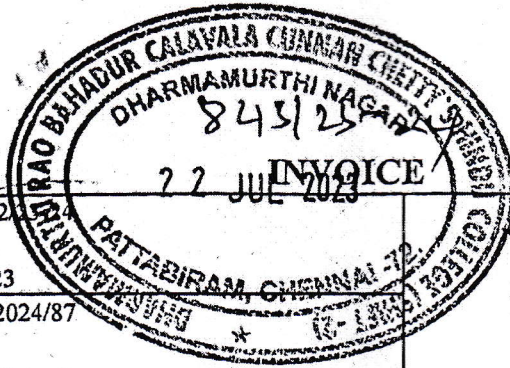

R
21/7/23

21/7
21/7/23

INVOICE NO ET/PI-062
 DATE 21.07.2023
 ORDER NO. 21/2023-2024/87
 DATE 20.07.2023
 TERMS 100% payment on delivery



EDUCORP TECHNOLOGIES

Old No.23/3, New No.59, South Usman Rd.,
 T.Nagar, Chennai-600 017
 Ph : 044-24341325
 Email : educorptech@gmail.com
 website: www.educorptech.com
 GST : 33AADFE9415E1ZR

BILL TO
 The Director,
 Dharmamurthi Rao Bahadur Calavala
 Cunnan Chetty's Hindu College,
 Dharmamurthi Nagar, Pattabiram,
 Chennai - 600 072.

SL.NO	DESCRIPTION OF GOODS	HSN CODE	QTY	RATE/UNIT	AMOUNT
1	Viewsonic Long Throw Multimedia Projector Model : PA503W	8528	3 Nos	34,500.00	1,03,500.00
	ADD CGST @ 14%				14,490.00
	SGST @ 14%				14,490.00
	TOTAL				1,32,480.00

(Rupees One Lakh Thirty Two Thousand Four Hundred and Eighty only)

1. BBA
 2. D.S
 3. A.T

Entered in Stock Register
 Head *Projector*
 Page No. *100*

Our Bank Details:
 BANK NAME : UNION BANK OF INDIA
 BRANCH : WEST MAMBALAM, CHENNAI
 ACCOUNT NO (CC) : 611705080000103
 ACCOUNT NAME : EDUCORP TECHNOLOGIES
 IFSC CODE : UBIN0561177

All disputes are subject to Chennai Jurisdiction only
 We declare that this invoice shows the actual price of the goods described and that all particulars are true and correct

for EDUCORP TECHNOLOGIES
 (AUTHORISED SIGNATORY)

21/7/23

TAX INVOICE

(DUPLICATE FOR TRANSPORTER)

CHALLENGER COMPUTERS PVT LTD
 833A, HEERA MARKET, ANNA SALAI
 MOUNTRoad
 GSTIN/UIN: 33AADCC6065B1Z5
 State Name : Tamil Nadu, Code : 33
 E-Mail : chacompmppm@rediffmail.com

Consignee (Ship to)
DRBCCC HINDU COLLEGE
 DHAMAMURHTI NAGAR
 PATTABIRAM
 CHENNAI
 State Name : Tamil Nadu, Code : 33

Buyer (Bill to)
DRBCCC HINDU COLLEGE
 DHARMAMURTHI NAGAR
 PATTABIRAM
 CHENNAI
 State Name : Tamil Nadu, Code : 33

Invoice No.	e-Way Bill No.	Dated
CC-001824	541532453587	2-Aug-23
Delivery Note	Mode/Terms of Payment	
Reference No. & Date.	INVOICE	
Buyer's Order No.	Other References	
Dispatch Doc No.	Dated	
Dispatched through	Delivery Note Date	
Destination		
Terms of Delivery		

Sl No.	Description of Goods	HSN/SAC	Quantity	Rate (Incl. of Tax)	Rate	per	Amount
1	INTEL CORE I3 10100 PROCESSOR	84733010	12 NOS	9,900.00	8,389.83	NOS	1,00,677.96
2	MSI B560M PRO-E MOTHER BOARD	84733020	12 NOS	6,499.99	5,508.47	NOS	66,101.64
3	I5 12400 PROCESSOR	84717010	6 NOS	17,750.00	15,042.37	NOS	90,254.22
4	GIGABYTE H610 MH MOTHERBOARD	84733020	6 NOS	7,750.00	6,567.80	NOS	39,406.80
5	CRUCIAL 8GB DDR4 RAM	847330	17 NOS	2,250.00	1,906.78	NOS	32,415.26
6	CRUCIAL 16GB DDR4 RAM	84733030	2 NOS	3,500.00	2,966.10	NOS	5,932.20
7	256GB SSD	84717090	9 NOS	2,250.00	1,906.78	NOS	17,161.02
8	ATX CABINET	84733099	4 NOS	1,500.00	1,271.19	NOS	5,084.76
9	ZEBRONICS CABINET & 450W SMPS	84733099	2 NOS	3,899.99	3,305.08	NOS	6,610.16
10	DELL KEYBOARD & MOUSE	84716040	5 NOS	900.00	762.71	NOS	3,813.55
11	SEAGATE 1TB SATA HDD	84717020	8 NOS	3,500.00	2,966.10	NOS	23,728.80
12	SAMSUNG 24" LED MONITOR	85285200	2 NOS	9,500.00	8,050.85	NOS	16,101.70
13	DELL 24 LED MONITOR	85285200	2 NOS	7,500.00	6,355.93	NOS	12,711.86
14	CANON 2900 PRINTER	84433100	1 NOS	17,500.00	14,830.51	NOS	14,830.51
15	DELL T40 SERVER	85176290	1 NOS	57,500.00	48,728.81	NOS	48,728.81
							4,83,559.25
OUTPUT CGST 9%							43,520.33
OUTPUT SGST 9%							43,520.33
ROUNDED OFF							0.09
Total			89 NOS				₹ 5,70,600.00

Amount Chargeable (in words) E. & O.E
INR Five Lakh Seventy Thousand Six Hundred Only

Declaration for CHALLENGER COMPUTERS PVT LTD
 We declare that this invoice shows the actual price of the goods described and that all particulars are true and correct.

Authorized Signatory

This is a Computer Generated Invoice

CHA
Prakash

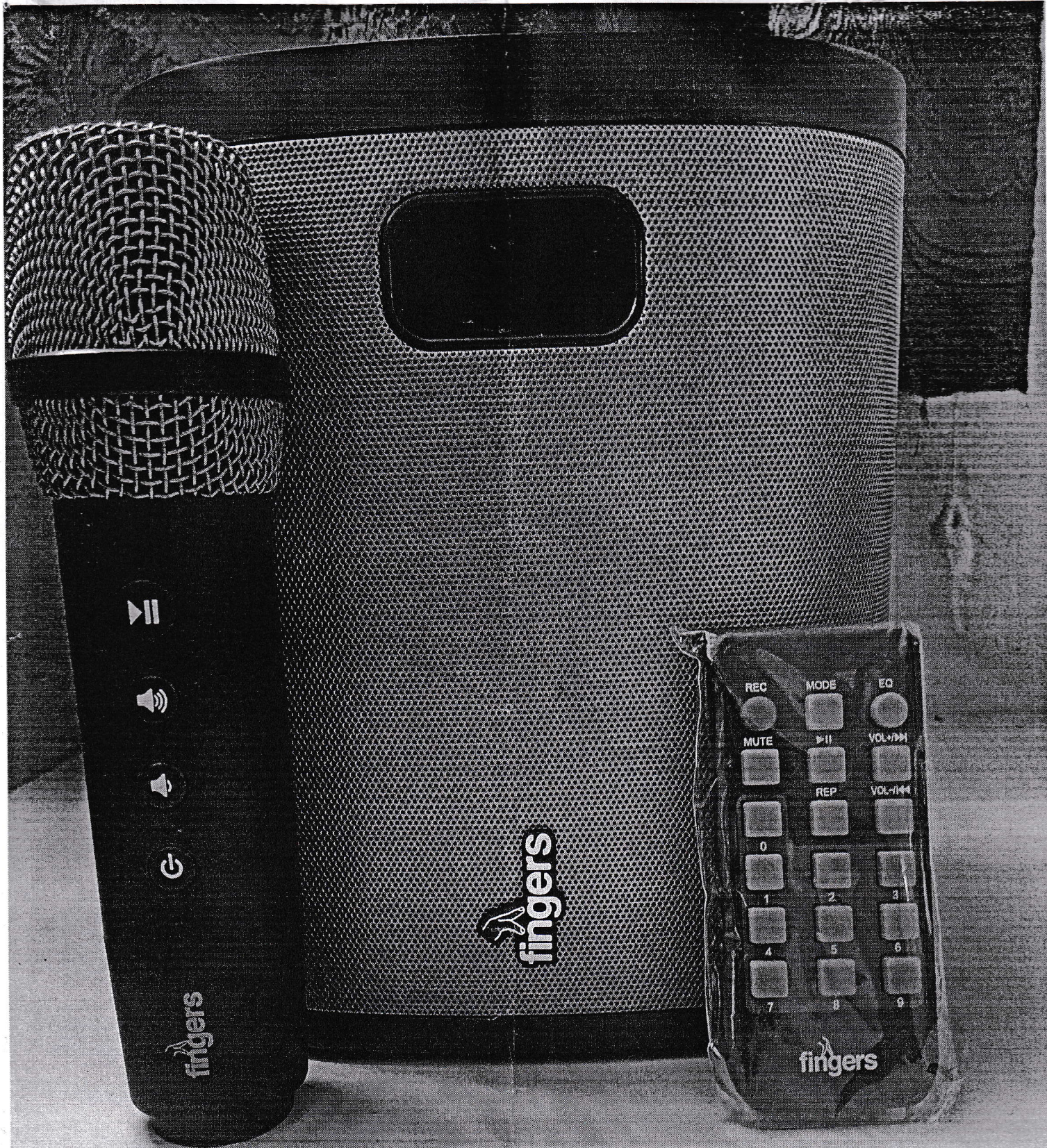

GPS Map Camera



Pattabiram, Tamil Nadu, India
SCIENCE BLOCK, FOOD CORPORATION OF INDIA-PATTABIRAM, Deena Dayalan Nagar,
Pattabiram, Tamil Nadu 600054, India
Lat 13.122428°
Long 80.074118°
20/03/24 12:52 PM GMT +05:30